

 FRL 60/60/60
FROM THE OUTSIDE

 Rw 47-48*

 R1.59 - 1.93
m²k/W*

 4.0 - 10 kN/m*

Design Guide

Hardie™ Smart Boundary Wall System
Class 1 & 10a Timber Frame Building

SYSTEMS

Australia November 2023

Make sure your information is up to date.

When specifying or installing Hardie™ products, ensure that you have the current technical information and guides. If in doubt, or you need more information, visit jameshardie.com.au or Contact James Hardie on 13 11 03.

*These values are calculated based on the use of 6mm Villaboard™ Internal Lining.

INDEX

- Introduction** 2
- System specification** 3
 - Boundary wall system 3
 - System performance 3
 - Main components 3
 - Other components 4
 - Tools 4
- Overview and applications** 4
 - What is a boundary wall system? 4
 - Advantages 4
 - Minimum requirements 4
 - Applications 5
- Inspections and certification** 5
- Safe work practices** 5
 - Fibre cement 5
 - Hardie™ Fire Insulation 5
- Design considerations** 6
 - General 6
 - Slab and footings 6
 - Boundary setback 6
 - Fire resistance 6
 - Bracing performance 7
 - Thermal performance 7
 - Weather resistance 7
 - Coastal areas 7
 - Fastener type limitation 7
 - Component installation 7
 - Component substitution 8
 - Structure and framing 8
 - Services and fixtures 12
- Details** 13
 - Base details 13
 - Floor junctions 14
 - Window details 15
 - Roof junctions 15
 - Wall junctions 19
- Online tools** 23
- Warranty** 23
- Codemark certification** 23

INTRODUCTION

This guide contains product information, technical specification, construction details and design considerations for the Hardie™ Smart Boundary Wall System.

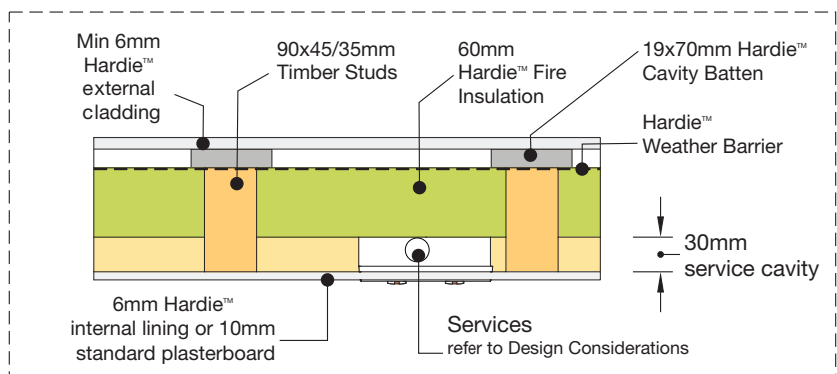
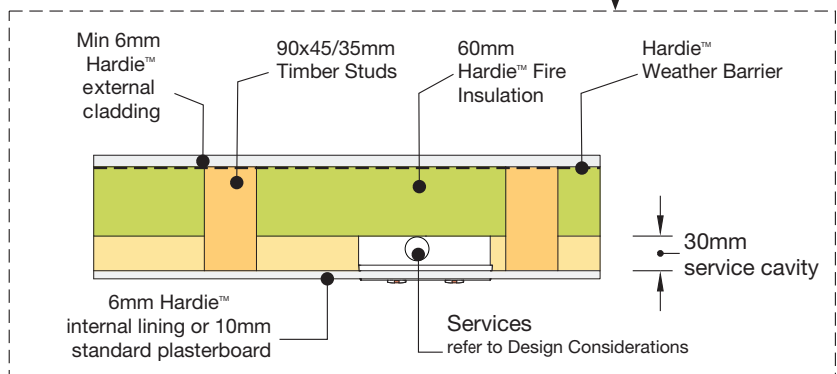
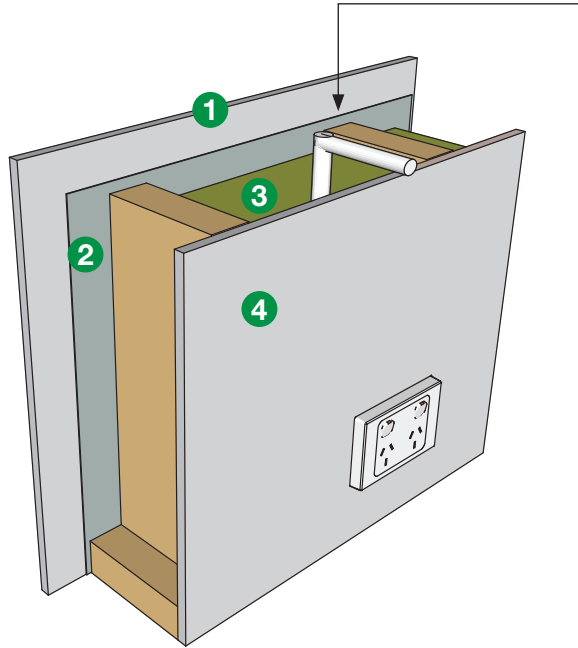

SYSTEM SPECIFICATION

BOUNDARY WALL SYSTEM

For external residential walls in close proximity to the boundary.

SYSTEM PERFORMANCE



FRL

60/60/60 minutes

FROM THE OUTSIDE



Total R-value

1.59 - 1.93 m²k/W*

Refer to the Thermal Performance section on Page 7 for further information.



Bracing

4.0 – 10 kN/m*

(depends on fixing method and selected cladding, refer to Design Considerations).



Min Wall Thickness

102 mm

*These values are calculated based on the use of 6mm Villaboard™ Internal Lining. Please refer to Design Considerations for framing specification, structural capacity, fire resistance and other limitations.

MAIN COMPONENTS

1

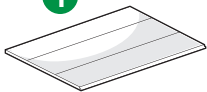

HARDIE™ EXTERNAL CLADDING

Selected Hardie™ external cladding must be at least 6mm thick sheets or 7.5mm boards. To see our range of suitable external cladding products, visit jameshardie.com.au or Contact James Hardie on 13 11 03.

2



HARDIE™ WEATHER BARRIER

A non-perforated, highly breathable and reflective safe-glare weather barrier designed to be used behind cladding.

Size (mm)	Part No	Coverage (m ²)
2750 x 30,000	305664	82.5

Weight per roll (kg) 9

3

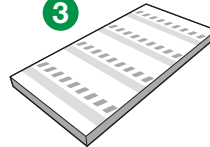

60MM HARDIE™ FIRE INSULATION

Mineral wool insulation specifically designed for use in fire applications with select Hardie™ Smart Systems.

Pack Size

7

Size (mm)

560x1160x60

Part No

305903

Coverage (m²)

5.1

420x1160x60

305902

3.8

420x1320x60

305909

4.3

Thickness (mm)

60

Material R-value (m² .K/W)

1.7

Density (kg/m³)

80

4

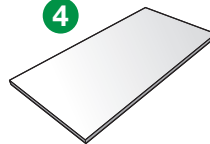

HARDIE™ INTERNAL LINING

Selected Hardie™ internal lining must be at least 6mm thick. To see our range of suitable internal products, visit jameshardie.com.au or Contact James Hardie on 13 11 03. 6mm Villaboard™ Lining is a fibre-cement sheet with a recessed edge. Suitable for tiled and untiled internal wall applications in dry and wet areas.

VILLABOARD™ 6MM LINING

Sizes (mm)

900 x 2400

1200 x (1800, 2400, 2700, 3000, 3600, 4200)

1350 x (2400, 3000, 3600, 4200)

Part No

See Villaboard™ Lining manual

Mass (kg/m²)

8.3

Alternatively, 10mm standard plasterboard can be used in dry areas only as internal lining. The product must comply to the requirements of AS/NZS 2588 - Gypsum Plasterboard.

OTHER COMPONENTS

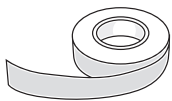

LINING/CLADDING ACCESSORIES

Refer to the respective product installation guide for information relating to additional system components such as corner extrusions, tapes etc.

All dimensions and masses provided are approximate only and subject to manufacturing tolerances. Masses are based on equilibrium moisture content of product.

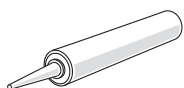

SEALANTS

(NOT SUPPLIED BY JAMES HARDIE)

Fire and Acoustic-Rated Sealant

Use Bostik FireBan One fire rated sealant or equivalent. If using an equivalent sealant it must be tested in accordance with AS 1530.4 and achieve a minimum 60 minute fire rating. Contact the relevant sealant manufacturer for more information.

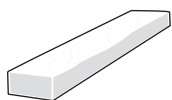

OTHER

(NOT SUPPLIED BY JAMES HARDIE)

Fire Resisting Mineral Wool

Used to seal cavities and maintain FRL at junctions of the selected wall system. Please see Construction Details for applications. Refer to manufacturer for guidance on installation.

TOOLS



Reciprocating Saw, Utility Knife or Hand Saw for Cutting Hardie™ Fire Insulation

Used for cutting insulation when required. Ensure to cut 5mm wider than required to ensure compression of insulation in the cavity.

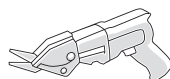

Tools For Fibre Cement

A suite of tools are available for cutting and handling Hardie™ fibre cement. Please refer to Hardie™ Best Practice Guide for more information.

OVERVIEW AND APPLICATIONS

WHAT IS A BOUNDARY WALL SYSTEM?

A boundary wall system is used when external walls of a building are within close proximity to the allotment boundary or another building on the same allotment. These distances and requirements are specified by the National Construction Code (NCC), see Applications.

The Hardie™ Smart Boundary Wall System comprises a 90mm timber frame insulated with 60mm Hardie™ Fire Insulation within the stud bays (refer to System Specification for more information). The frame is covered on both sides; externally with Hardie™ Weather Barrier and 6mm or thicker Hardie™ cladding, while internally with 6mm or thicker Hardie™ lining.

ADVANTAGES

- Can be retrofitted where a fire-rated system is required post-installation of Hardie™ external cladding,
- Single layer system, no need for additional layers,
- Maximises indoor space using a compact solution.

MINIMUM REQUIREMENTS

The Hardie™ Smart Boundary Wall System is suitable for use in class 1 and 10a timber-framed buildings with a FRL requirement of 60/60/60 minutes or less from the external face (one way).

APPLICATIONS

Some of the main applications are depicted below. These are based on NCC Volume 2 and do not cover all applications and limitations. The designer must check all

NCC requirements before specifying. If more information is required to assess suitability, please contact James Hardie.

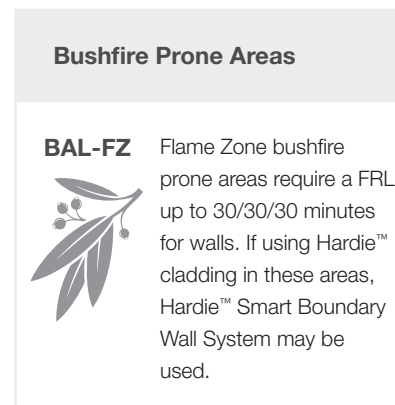
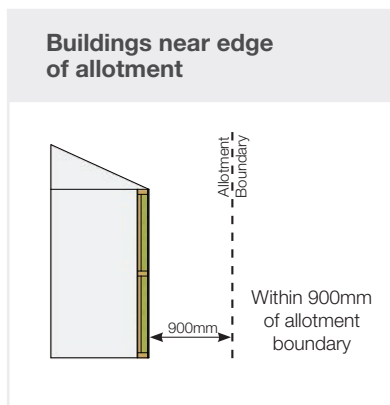
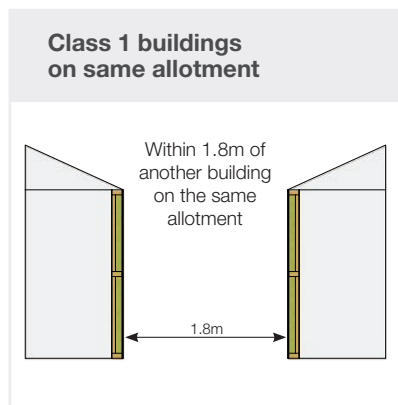

INSPECTIONS AND CERTIFICATION

The Hardie™ Smart wall system may require inspection and certification by a third party to ensure the construction conforms to the relevant requirements of the NCC and local regulations. The inspections will typically be carried out by a certifier or surveyor.

We can also provide any relevant documentation, such as the relevant CodeMark certificate and test reports, to certifiers and surveyors upon request via our Technical Team on 13 11 03.

SAFE WORK PRACTICES

FIBRE CEMENT

Hardie™ products contain sand, a source of respirable crystalline silica.

May cause cancer if dust from product is inhaled. Causes damage to lungs and respiratory system through prolonged or repeated inhalation of dust from product.

During installation or handling, ensure to follow Hardie™ Best Practice Book and SDS for Hardie™ fibre cement products available at jameshardie.com.au.

HARDIE™ FIRE INSULATION

ELECTRICAL CONDUCTIVITY

Foil facings are conductive to electricity. Care must be taken when installing Hardie™ Fire Insulation in the proximity of electrical wiring and lighting fixtures. Avoid contact with uninsulated electrical cables and fittings. If required, Hardie™ Fire foil facing may be removed using a utility knife. Consult a qualified Electrician, or contact James Hardie for further information.

STORAGE AND HANDLING

Store in an internal dry area, out of direct sunlight and not exposed to chemicals. It must not be installed during an electrical storm and it must be installed in a dry state to a dry surface and protected from weather during transport and storage. Hardie™ Fire Insulation has not been designed to withstand prolonged direct exposure to the exterior elements. Ensure that the insulation is completely dry prior to fitting.

PROTECTIVE EQUIPMENT

Keep exposure to a minimum and minimise quantities kept in work areas. Avoid contact with eyes. When handling and installing Hardie™ Fire Insulation, to prevent irritation ensure you wear:

- Safety goggles/glasses conforming to AS/NZS 1336,
- Protective clothing such as gloves and long sleeve shirts and trousers,
- P1 or P2 respirators.

BEFORE INSTALLATION

- You must turn the mains power 'Off' before entering the workspace. If in doubt, you must consult a licensed electrician.
- Care and safety measures must be followed when working in areas that contain live electrical wiring.
- Defective electrical cables, terminals or any other electrical wiring must be repaired by the relevant specialist prior to installation.
- Ensure workspace has adequate and ample ventilation. If working in confined spaces, it is recommended to use a M class or higher vacuum or other suitable dust extractors.
- Before entering workspace, complete a risk assessment inspection to identify and manage hazards including but not limited to electrical, site access and ventilation.

CUTTING

It is recommended to cut outdoors. If cutting indoors, please ensure that workspace is properly ventilated or M class or higher vacuum/dust extractors are used.

1. Position cutting station so wind will blow dust away from the user or others in working area.
2. Use either a hand saw or a reciprocating saw.

DISPOSAL

Discard any waste pieces of Hardie™ Fire Insulation in accordance with your local council guidelines. Dispose of the material in such a manner to prevent exposure and escape.

FURTHER HEALTH AND SAFETY INFORMATION

For more information refer to the Hardie™ Fire Insulation SDS available at jameshardie.com.au.

DESIGN CONSIDERATIONS

GENERAL

All design and construction must comply with the appropriate requirements of the NCC and other applicable regulations and standards. The specifier or other party responsible for the project must ensure that the details in this specification are appropriate for the intended application and that additional detailing is performed for specific design or any areas that fall outside the scope of this specification.

SLAB AND FOOTINGS

The slab and footings on which the building sits must comply with AS 2870 'Residential Slabs and Footings – Construction' and the requirements of the NCC.

BOUNDARY SETBACK

James Hardie recommends a minimum setback of 500mm from an existing structure. This is to allow for maintenance of the selected external cladding as per the respective installation instructions.

For systems built directly against an existing structure please refer to the Hardie™ Smart ZeroLot™ Design Guide.

Please note that council, state or other regulations may apply in your development which specify different setbacks, height, width and other design criteria.

FIRE RESISTANCE

NCC Vol. 2 Section H3D2 requires boundary walls to maintain an FRL of 60/60/60 minutes. Hardie™ Smart Systems have been assessed by the CSIRO Division of Building Construction and Engineering and the Building Research Association of New Zealand (BRANZ) in accordance with the principles of AS1530.4 (FCO-3222 Rev L).

BRACING PERFORMANCE

For two sided systems i.e. comprising of both Hardie™ external cladding and internal lining products of ≥6mm in thickness, the bracing capacity is typically 4 kN/m for plain timber framing and standard fixing methods.

The capacity may be increased to a range of 6-10 kN/m for other fixing methods and anchor rods of 12mm diameter.

For more information and specification, the designer must refer to Hardie™ Structural Bracing Application Guide (designed in accordance with AS 1684 'Residential Timber Framed Construction'). Hardie™ Structural Bracing Application Guide contains fixing details and bracing capacity for Hardie™ fibre cement cladding. All design capacities quoted are Ultimate Limit State (ULS) figures and have been certified by consulting engineers, Cardno (NSW). Pty Ltd.

THERMAL PERFORMANCE

This guide outlines certified modelled total R-Values for Hardie™ Smart Wall Systems. Use this information as part of the input data required in energy efficiency assessments, described in Part H6 of the NCC 2022 Vol 2.

The Total R-value is based on using Hardie™ Weather Barrier with an emissivity of 0.16W/m². The Total R-values for common systems are in accordance with AS/NZS 4859.2:2018 Thermal Insulation Materials for Buildings - Part 2: Design.

TABLE 1

R-VALUE PER WALL			
Stud Spacing (mm)	Battens	R-Value (Winter)	R-Value (Summer)
600	No battens	1.72	1.64
	Hardie™ Cavity Battens (19mm)	1.93	1.84
450	No battens	1.67	1.59
	Hardie™ Cavity Battens (19mm)	1.86	1.78

1. The above published Total R values for the above building system configurations were independently assessed in accordance with AS/NZS 4859.2:2018 Thermal insulation materials for buildings. Part 2: Design.
2. Timber frame results take the effects of thermal bridging into account.
3. 90x45mm timber frame, 2400mm wall height and noggins spaced at 1200mm centers.
4. Systems assessed by e3k New Products Design & Development (Report 080520)
5. *These values are calculated based on the use of 6mm Villaboard™ Internal Lining..

WEATHER RESISTANCE

The Hardie™ Smart Boundary Wall System external claddings have been designed in accordance with clause H2P2 of the NCC. For any variations, it is the responsibility of the designer or specifier to identify moisture related risks associated with any particular building design. Wall construction design must effectively manage moisture, accounting for both the interior and exterior environments

of the building, particularly in buildings that have a higher risk of wind-driven rain penetration or that are artificially heated or cooled. All wall openings, penetrations, intersections, connections, window sills, heads and jambs must be flashed prior to cladding installation.

COASTAL AREAS

In areas within 1km of a coastal area, areas subject to salt spray and other corrosive environments, Class 4 fasteners must be used. All other areas require a minimum Class 3 fastener. Fasteners must be fully compatible with all other materials that they are in contact with to ensure the durability and integrity of the assembly. Contact the fastener manufacturer for more information.

FASTENER TYPE LIMITATION

Brad nail and/or adhesive fixings are not recommended in fire and acoustic-rated systems. Please refer to the respective lining or cladding for alternative fixing methods.

COMPONENT INSTALLATION

HARDIE™ WEATHER BARRIER

Refer to the Hardie™ Weather Barrier datasheet for more information on standard installation.

60mm HARDIE™ FIRE INSULATION

Must be used as the frame cavity infill and must be compressed 5mm minimum in both vertical and horizontal directions (i.e. batt size must be at a minimum 5mm wider and longer than frame stud bay). Avoid joints in insulation batts, if present, all gaps must be filled with compressed Hardie™ Fire Insulation. Position batts hard against external wall face to allow for an internal service cavity.

HARDIE™ INTERNAL LINING

Villaboard™ Lining must be installed in accordance with the current Villaboard™ Lining installation instructions. Alternative Hardie™ internal linings with a minimum of 6mm thick may be used when installed in accordance with the relevant manual. In dry areas only, 10mm standard plasterboard can be used as a variation from Hardie™ internal linings.

HARDIE™ EXTERNAL CLADDING

Any Hardie™ external cladding 6mm or thicker may be used (flat sheet or weatherboard type). It must be installed in accordance with the respective installation instructions.

OTHERS

For other components not supplied by James Hardie ensure to follow the instructions set out in this guide and the respective manufacturer's recommendations.

COMPONENT SUBSTITUTION

Hardie™ fibre cement products and components such as Hardie™ Fire Insulation and Hardie™ Weather Barrier must be as specified in the system.

No statement of performance will be provided by James Hardie when alternative products are used.

STRUCTURE AND FRAMING

NCC Section H1D6 requires timber framing to be designed and constructed in accordance with AS1684 suite which defines the minimum requirements for compliance including, but not limited to maximum of three storeys, spans, cantilevers, maximum wall heights, timber grades, timber cross-sections, lateral restraint, bracing, racking and axial capacity. The specifier or other party must ensure that any details outside the scope of the AS1684 suite is engineered to comply with the relevant structural performance provisions of the NCC.

In addition to the above, the following table and details in this guide provide further structural constraints and conditions to maintain the fire resistance level (FRL) of the wall system. For any applications outside the scope of the tables below, contact the Technical Team on 13 11 03.

MATERIAL

Seasoned timber only. Timber used for house construction must have the level of durability appropriate for the relevant climate and expected service life. Must use minimum MGP10 grade timber in accordance with AS1748, or LVL with equivalent strength, stiffness and density properties, manufactured in accordance with AS/NZS 4357.0. Reference AS1684 'Residential Timber Framed Construction'.

STRUCTURAL CAPACITY

The load bearing capacities of the timber-framed walls must be in accordance with AS1684 and AS1720. Note that studs and joists should be aligned with minimum offset, or the load diverted by structural blocking or other method, in accordance with relevant timber codes and standards.

TABLE 2

LOAD BEARING WALLS			DRILLED STUDS*	
Max Stud Height* (mm)	Min Stud Size (mm)	Stud Load Capacity (kN/stud)	Maximum Wind Load	
			600mm centres	450mm centres
2700	90x35	3.1	N3	N3/C1
	90x45	4.3	N4/C1	N4/C1
3000	90x35	3.1	N2	N3
	90x45	4.3	N2	N3
3300	90x35	2.9	-	-
	90x45	3.7	N1	N2
3600	90x45	2.9	-	N1
3900	90x70 (2@90x35)	3.5	N1	N2
4200	90x90 (2@90x45)	3.6	N2	N2

* In accordance with Figure 1 Framing Configuration diagram.
 ~ Only applies to studs which are drilled horizontally to pass services. Refer to Framing Configuration diagram.

TABLE 3

NON-LOAD BEARING WALLS	
Max Stud Height (mm)	Min Stud Size (mm)
3600	90x35
4200	90x45
4500	90x90 (2@90x45)

NOTE: When walls are to be drilled to pass services refer to Wind Load limits in Table 2 Loadbearing Walls and Figure 1 Framing Configuration diagram.

STUD SPACING

600mm maximum. Check whether you require closer stud spacings for your site wind pressures and tile weight (where applicable). ^See Table 2 Structural Capacity to the left.

Hardie™ Fire Insulation sizes have been optimised for 45mm studs at 600mm centres and 35mm studs at 450mm centres, cutting may be required otherwise.

NOGGING FOR LOAD BEARING WALLS

Minimum 90mm deep. Installed flat in accordance with Figure 1 Framing Configuration diagram

Maximum 1200mm

NOTE: It is recommended noggings installed in line instead of staggered to facilitate insulation installation.

CANTILEVERED FLOORS

Cantilevered floors maximum span need to be designed in accordance with 'AS1684.2 Residential timber-framed construction'. Please refer to your Structural Engineer or qualified person for further design analysis.

STUD DRILLING

Where the stud is to be penetrated horizontally to allow services to pass between stud bays, only 1 in every 5 studs may be drilled a maximum of 25mm in diameter 10mm from the edge. Any larger or additional penetrations must *not* be located within the middle third of the stud height as per Figure 1 Framing Configuration diagram below, and may require reduced stud spacing, or thicker studs in accordance with the Table 2 Structural Capacity table. Refer to Figure 1 diagram D.

TOLERANCE

Ensure frame is square and work from a central datum line. Frames must be straight and true to provide a flush face to receive the sheeting. A suggested maximum tolerance of between 3mm and 4mm in any 3000mm length will give best results.

SACRIFICIAL TIMBER

Sacrificial timber blocking (also known as char blocking) is used in addition to the standard timber framing to protect structural members from fire. Sacrificial timber is differentiated by red hatching in the Construction Details section of this guide.

Sacrificial timber should have a minimum density of 550kg/m³, and be pine of minimum 45mm thickness. Blocks are to be arranged so that they are continuous or, additional blocking installed in front of any joints.

Ensure framing manufacturer accounts for additional sacrificial timber blocking at wall, floor and roof junction as per Figure 1.

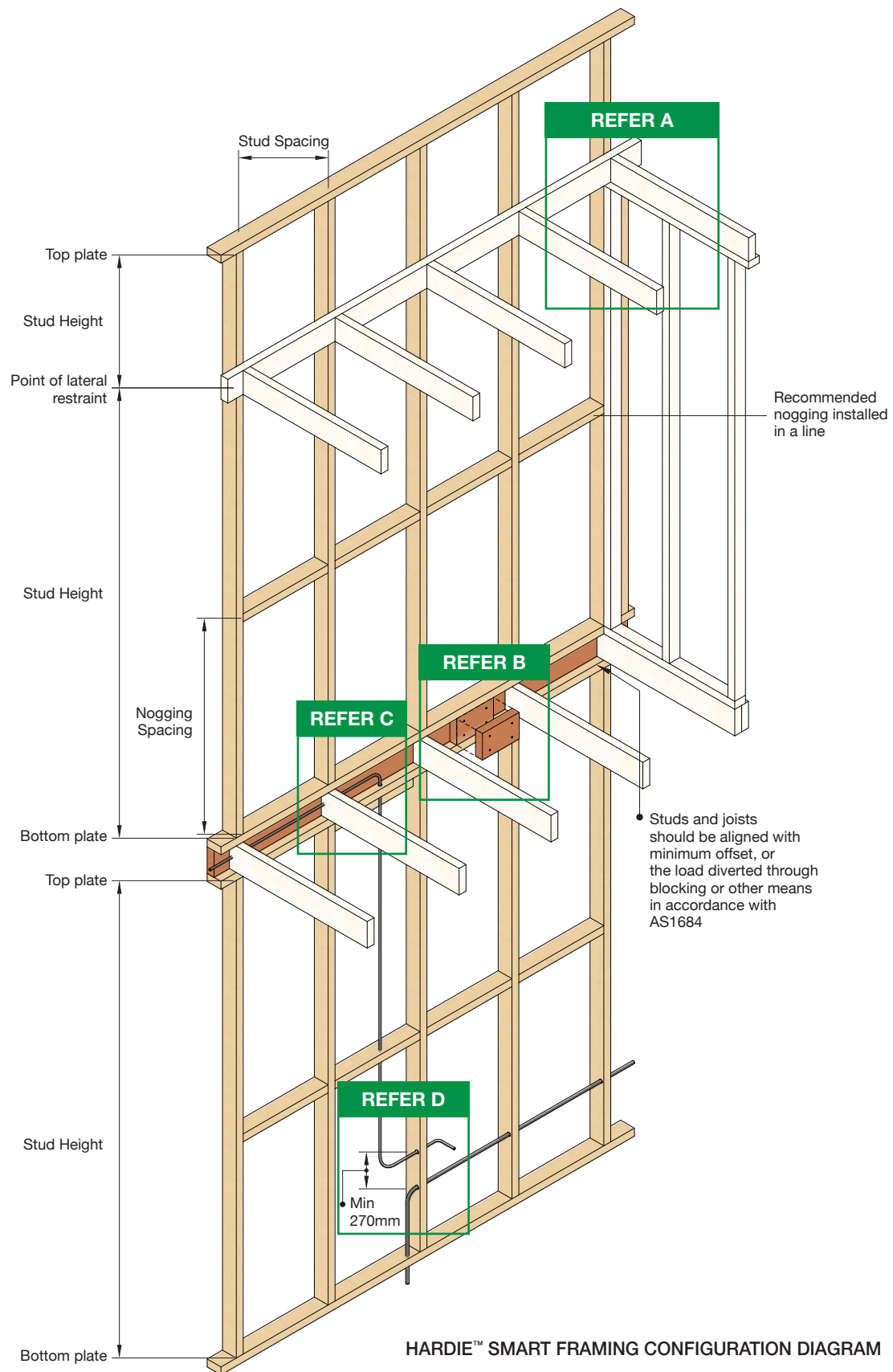
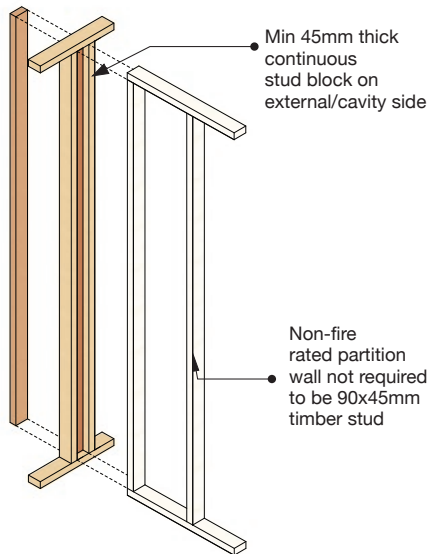
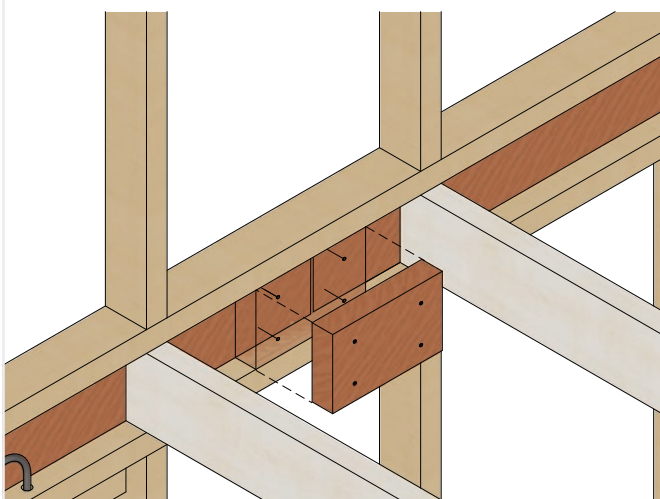

FIGURE 1

A INTERNAL WALL JUNCTION



B JOINT MUST BE BLOCKED WITH 45MM TIMBER AFFIXED USING 2 X 70MM LONG NAILS BOTH SIDES OF JOINT. THE BLOCK MUST EXTEND 100MM EITHER SIDE OF JOINT.



C WHERE 25MM DIA HOLE PENETRATES THROUGH STUD PLATE, INSTALL A 70X45MM THICK PROP BETWEEN ADJACENT STUDS AND ALIGN AGAINST EXTERNAL SIDE

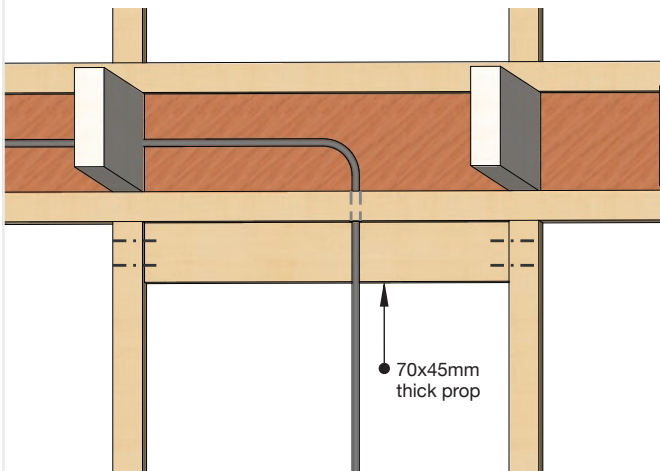

D WHERE MORE THAN 1 IN 5 STUDS IS TO BE DRILLED TO PASS SERVICES, THE STUD MUST BE DRILLED AS PER ONE OF THE FOLLOWING OPTIONS:

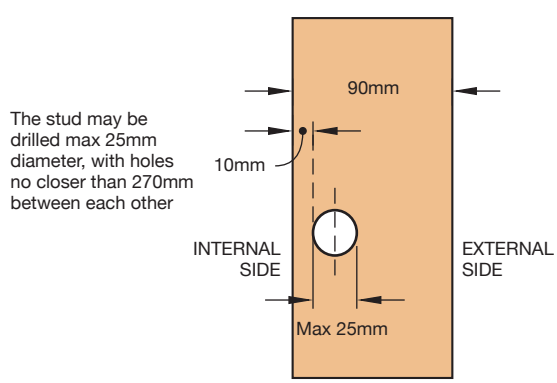
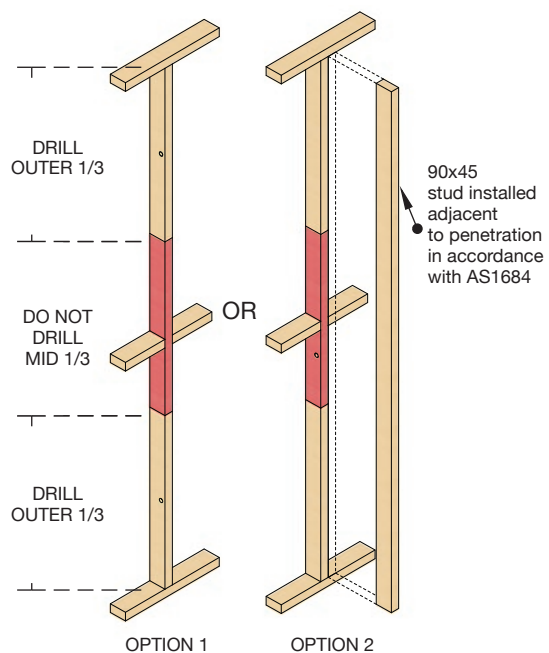

SERVICES AND FIXTURES

Services may be positioned within the 30mm service cavity without penetrating the insulation. If the lining is penetrated it must be protected with fire sealant around the perimeter. Where a stud is to be penetrated to pass services horizontally, refer to the Figure 1 Structure and Framing section.

NOTE: For penetrations through the building envelope (ie, from inside the building to outside) contact the Technical Team on 13 11 03. **WARNING: When fixing lining, avoid nailing near pipes or cables as it may cause damage.**

ELECTRICAL CABLES

Electrical cables may be run within the service cavity. Cables should be pinned to the stud edge. Refer to Figures 17-19.

PLUMBING AND ELECTRICAL CONDUITS

Plumbing pipes with a diameter up to 20mm may be run in the service cavity as per Figure 1. Any larger pipes must be relocated to non-fire rated partitions. For taps and other details, refer to Figures 20-22.

AIR-CONDITIONING

Pipes with an outside diameter up to 20mm and carrying non-flammable refrigerants may be run inside the service cavity as per Figure 1.

WALL FIXTURES

When fixing brackets, cabinets, shelves or any other fixture that requires the wall to carry a load, they must be fixed to the framing member (i.e. studs) and must not rely solely on the lining.

DETAILS

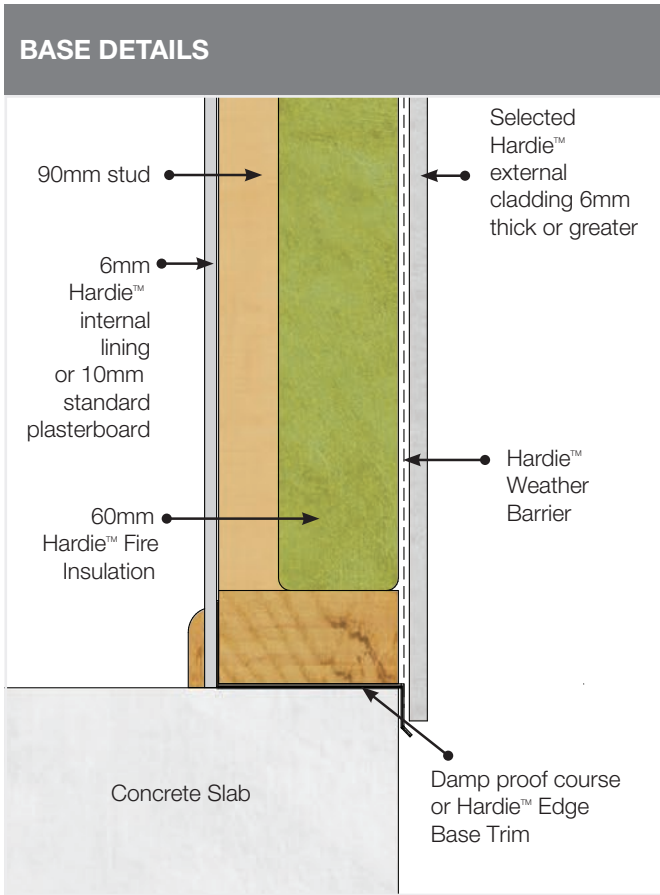

FIGURE 2 SLAB DETAIL

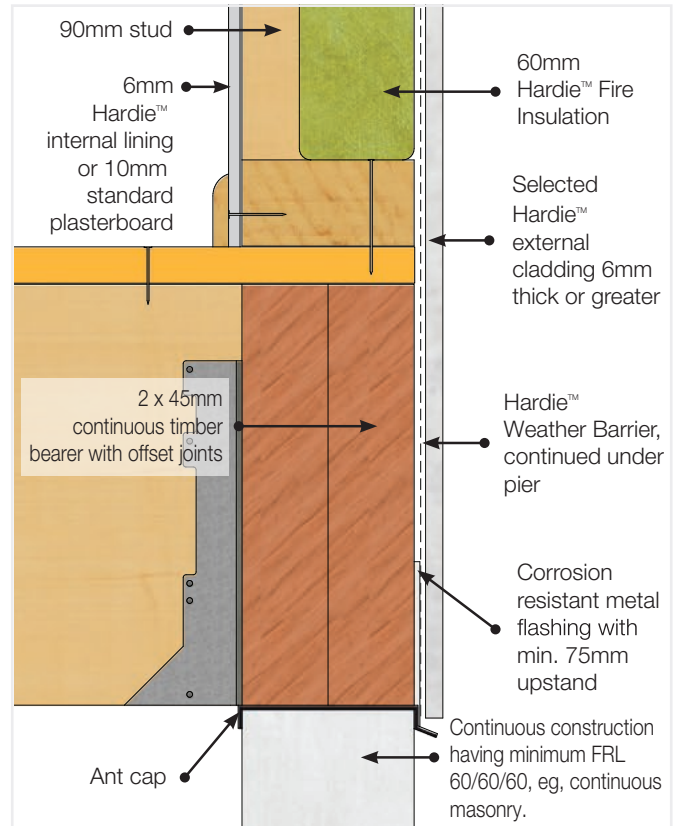

FIGURE 3 WALL BASE TO SUSPENDED GROUND FLOOR

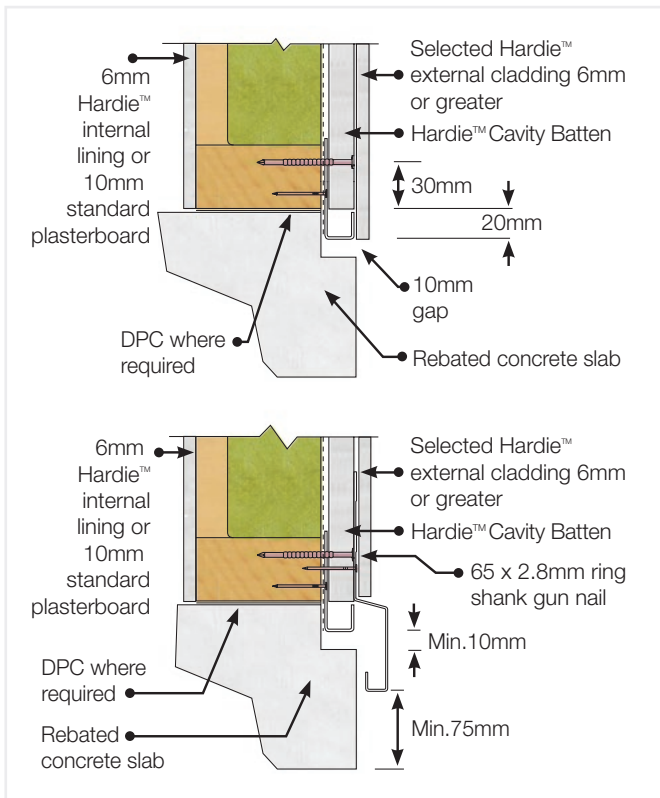

FIGURE 4 HARDIE™ CAVITY BATTEN SLAB EDGE DETAIL

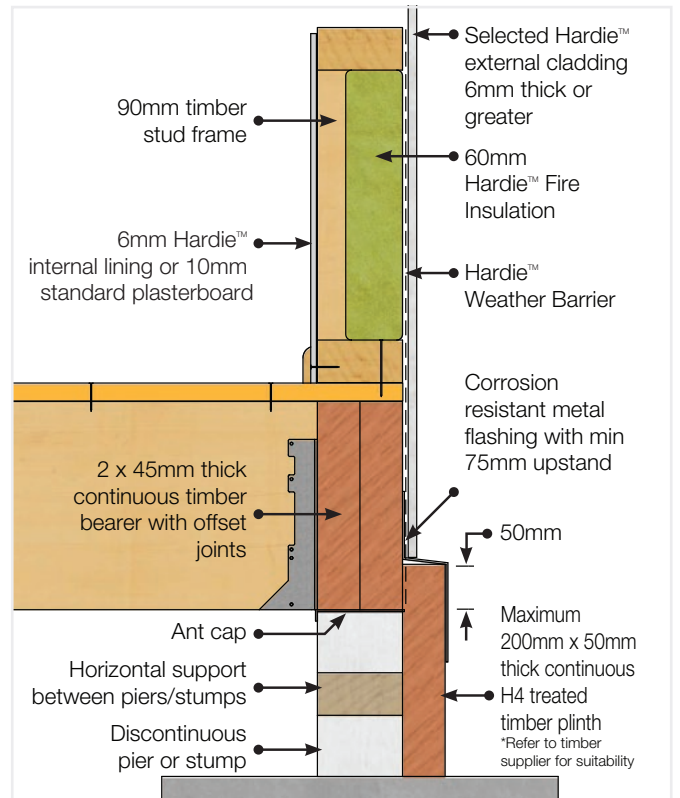

FIGURE 5 PLINTH DETAIL

FLOOR JUNCTIONS

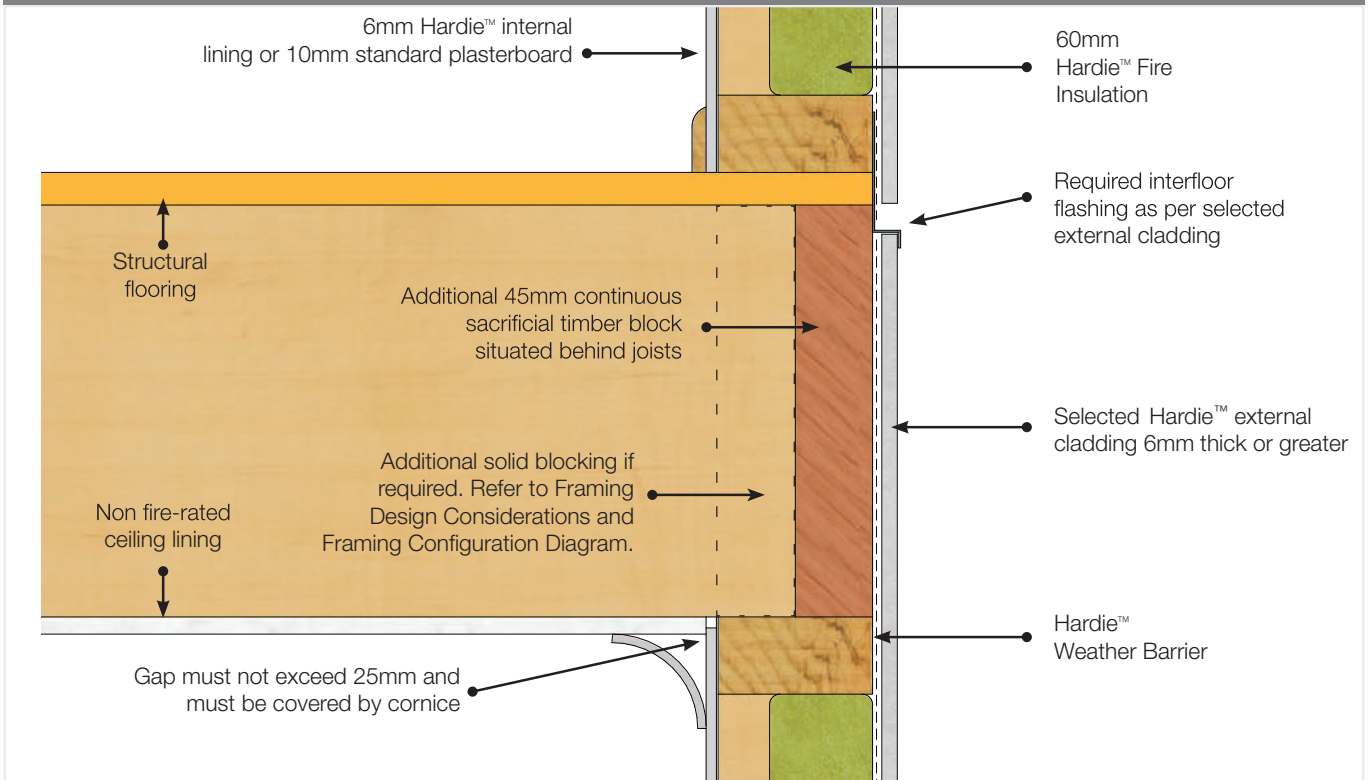

FIGURE 6 UPPER STOREY FLOOR JUNCTION OPTION 1

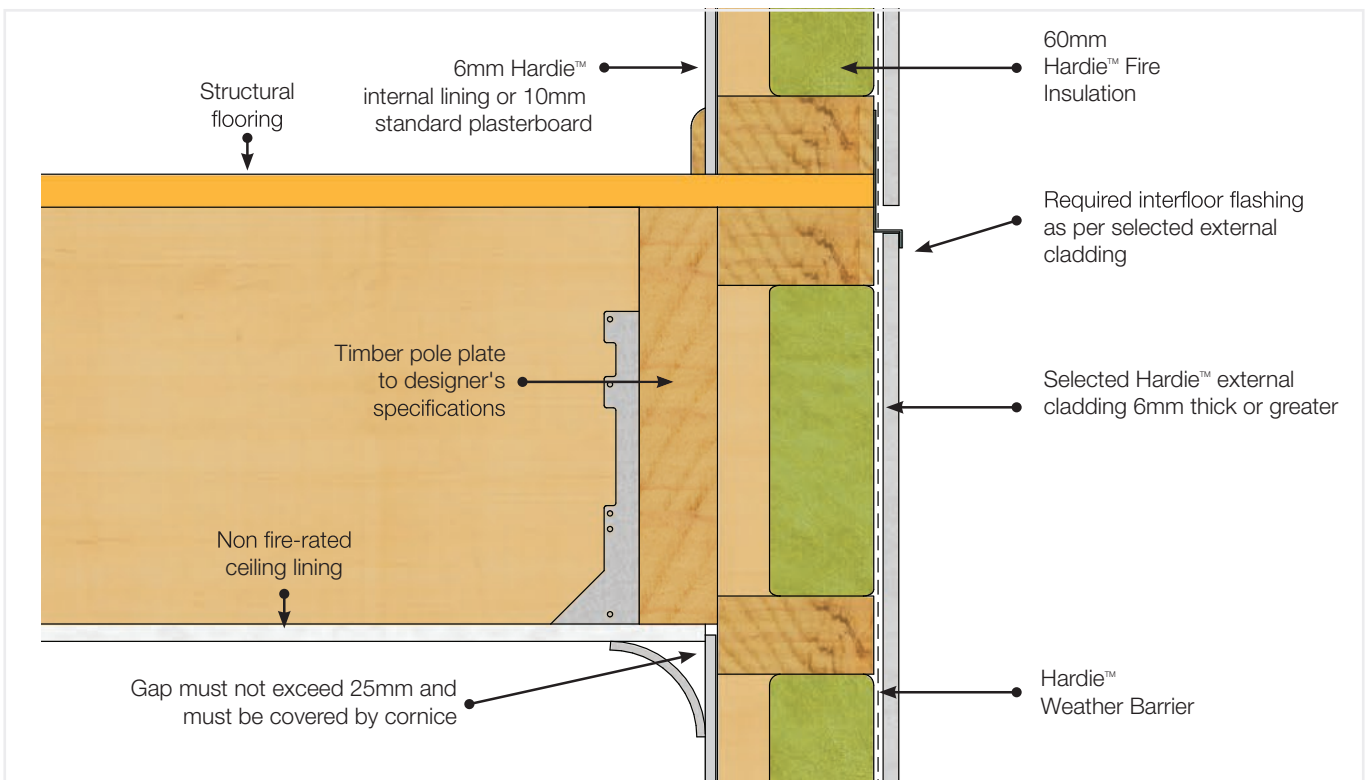

FIGURE 7 UPPER STOREY FLOOR JUNCTION OPTION 2

Figure referenced in FCO-3222J Page 13 - Gap backed by continuous timber block.

WINDOW DETAILS

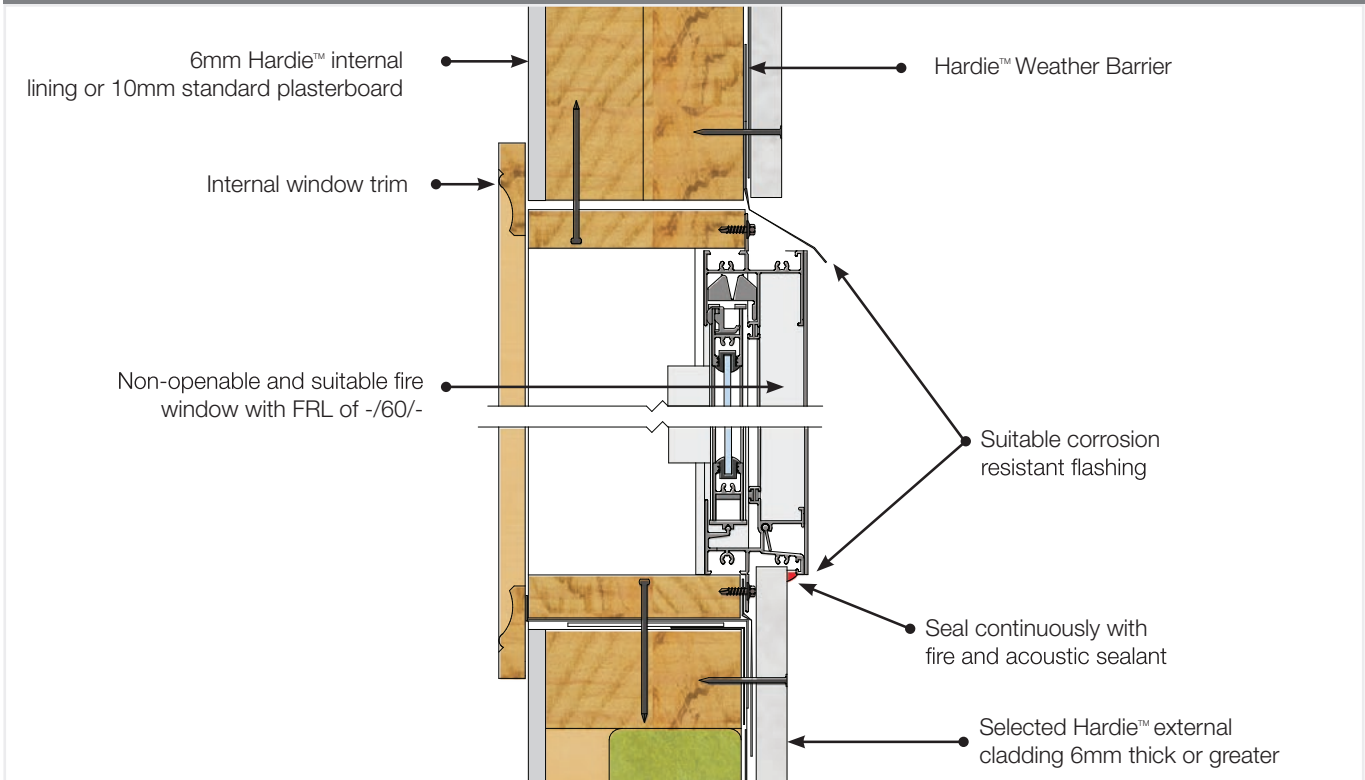

FIGURE 8 FIRE RATED EXTERNAL WINDOW (GUIDE ONLY, PLEASE REFER TO WINDOW MANUFACTURER)

ROOF JUNCTIONS

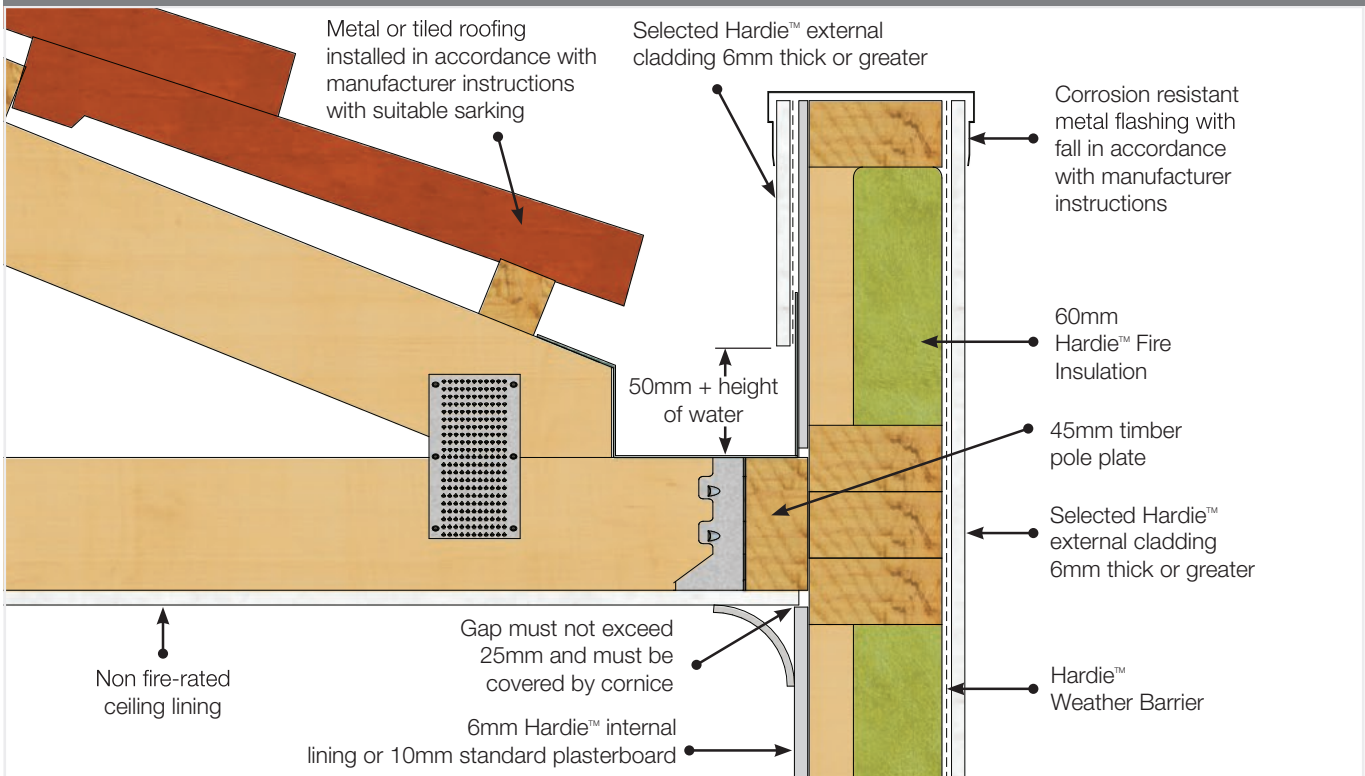

FIGURE 9 EXTERNAL BOUNDARY WALL TO PARAPET ROOF

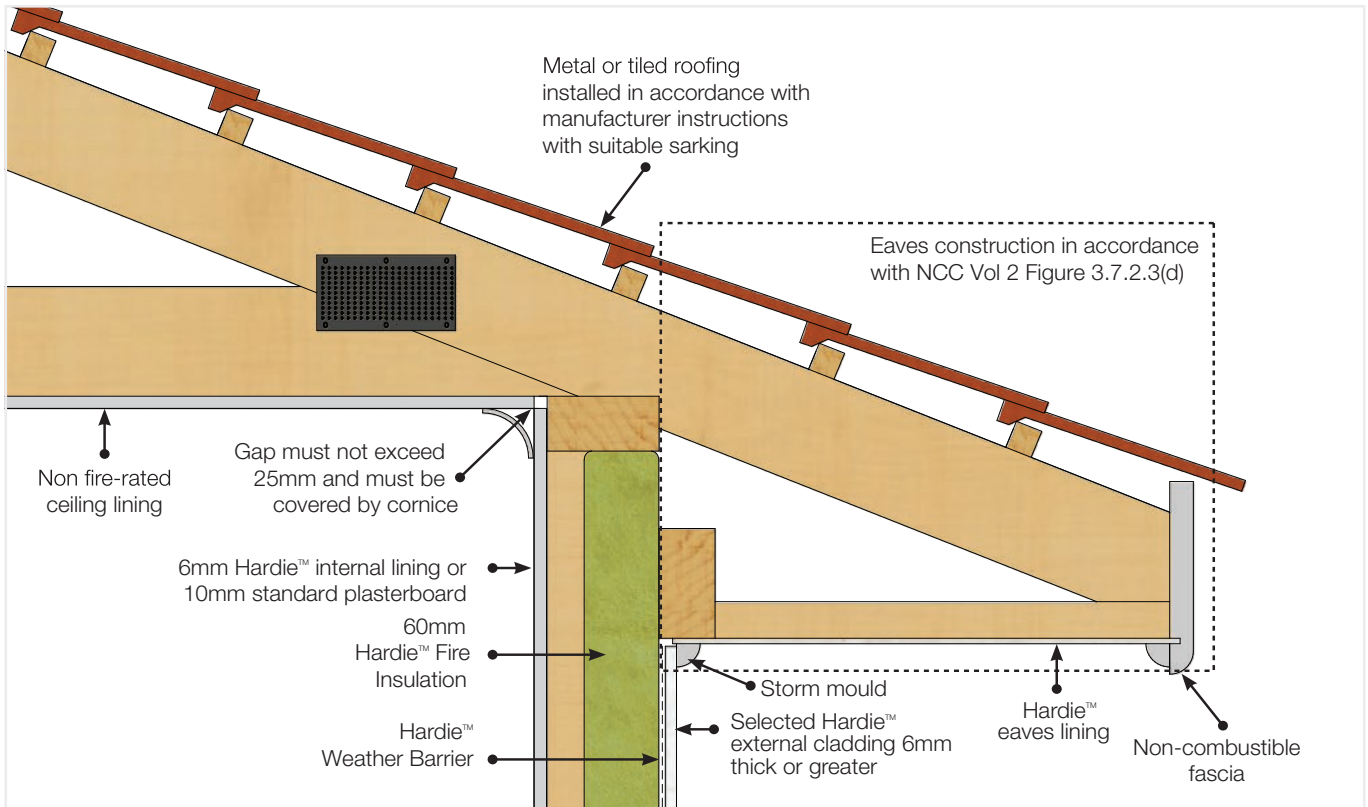

FIGURE 10 EXTERNAL BOUNDARY WALL TO HARDIE™ EAVE LINING

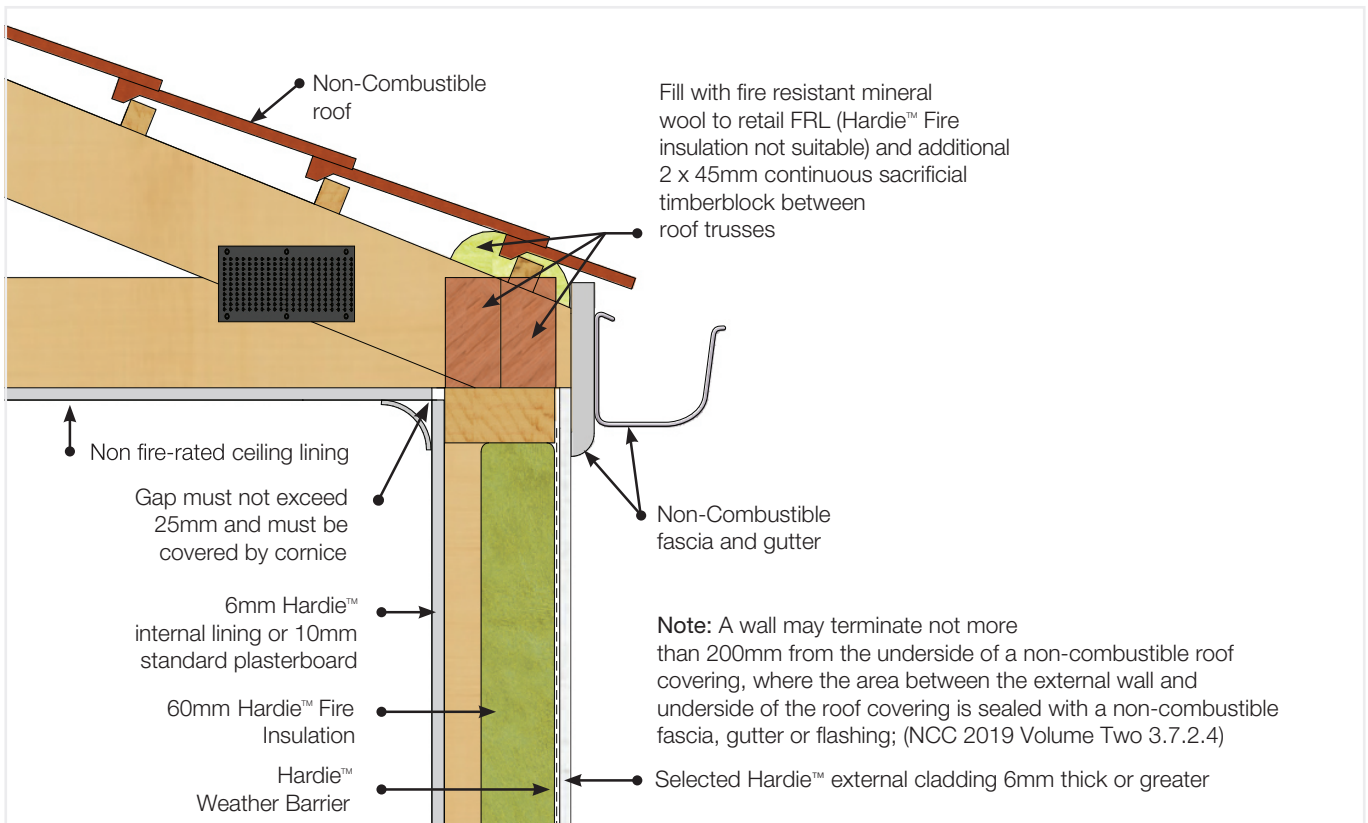

FIGURE 11 EXTERNAL BOUNDARY WALL TO ROOF

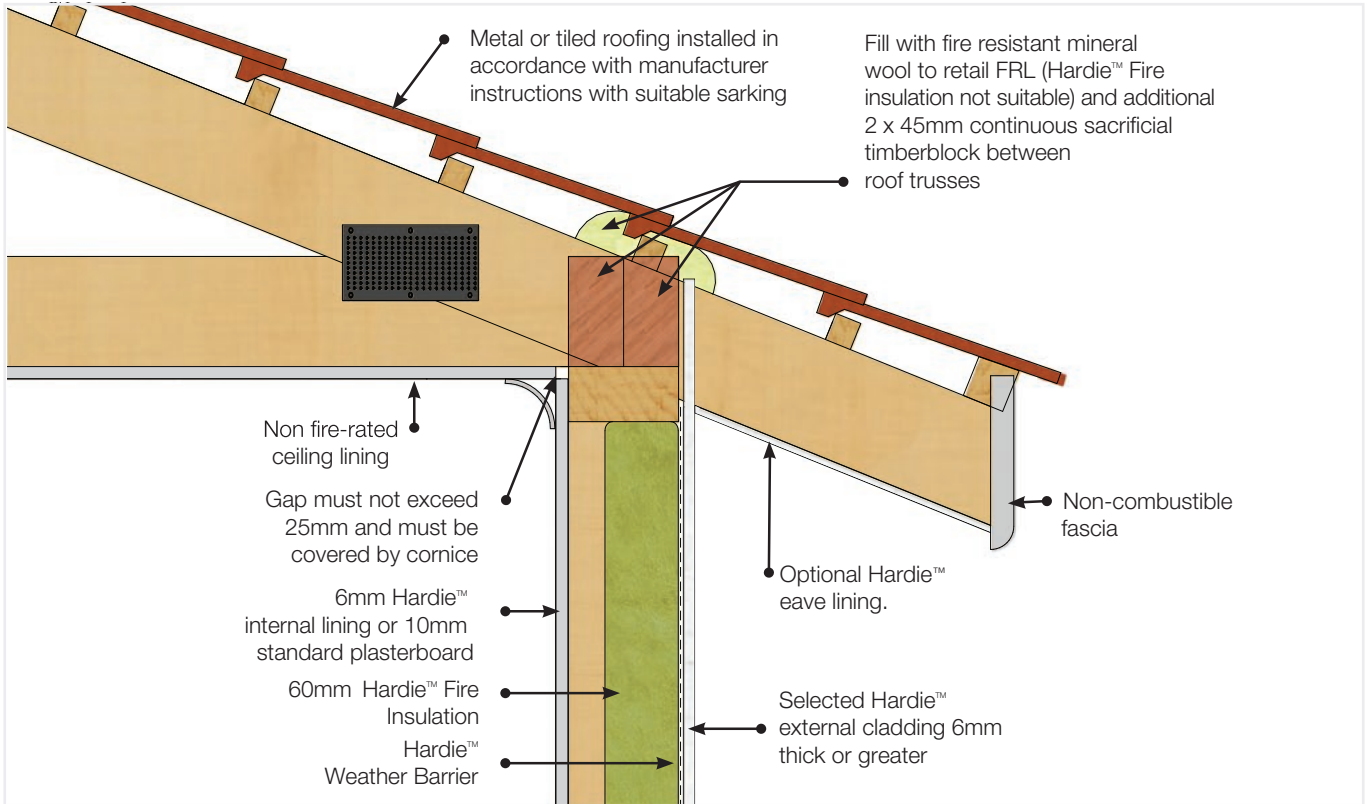

FIGURE 12 EXTERNAL BOUNDARY WALL TO ROOF WITH EAVE

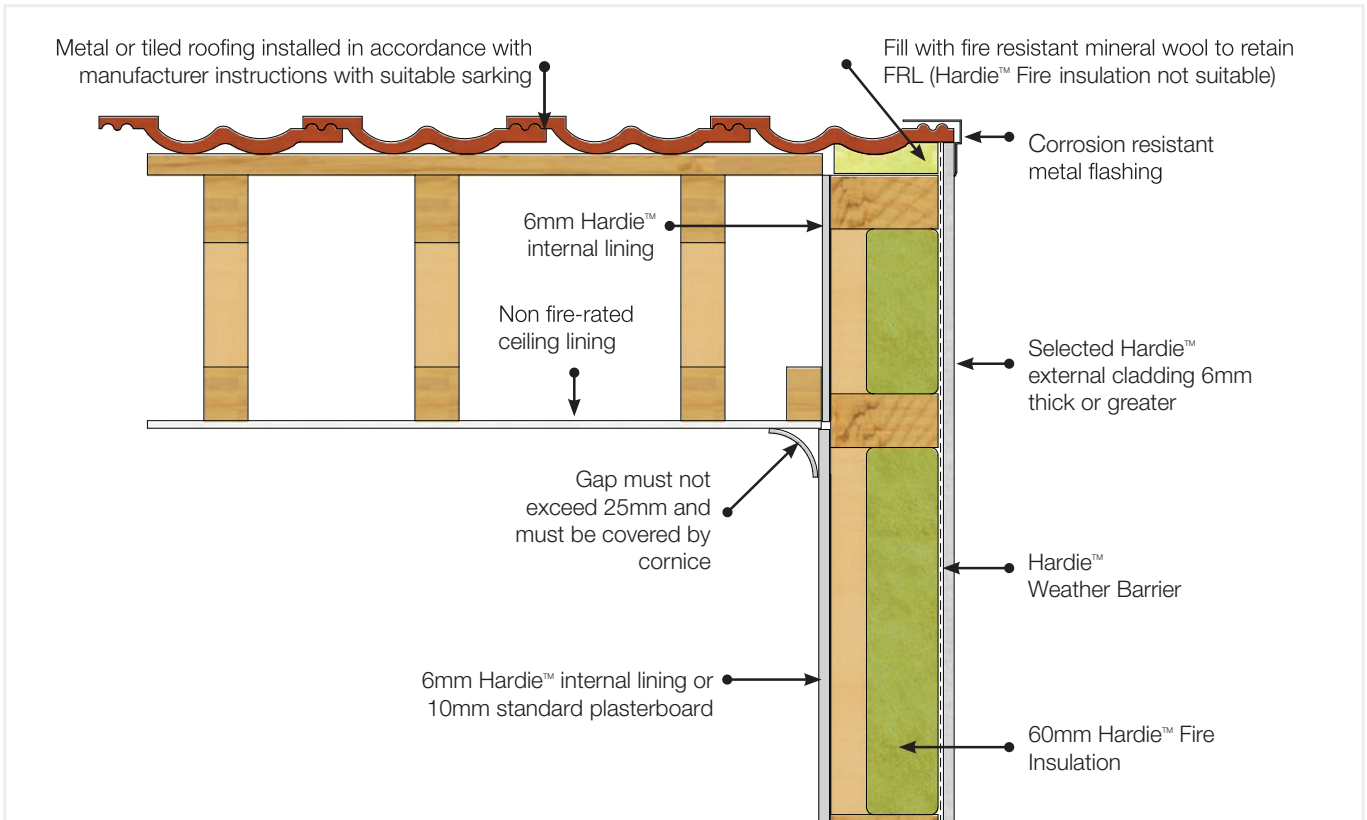

FIGURE 13 EXTERNAL BOUNDARY WALL TO PARAPET ROOF WITH PARALLEL ROOF TRUSSES

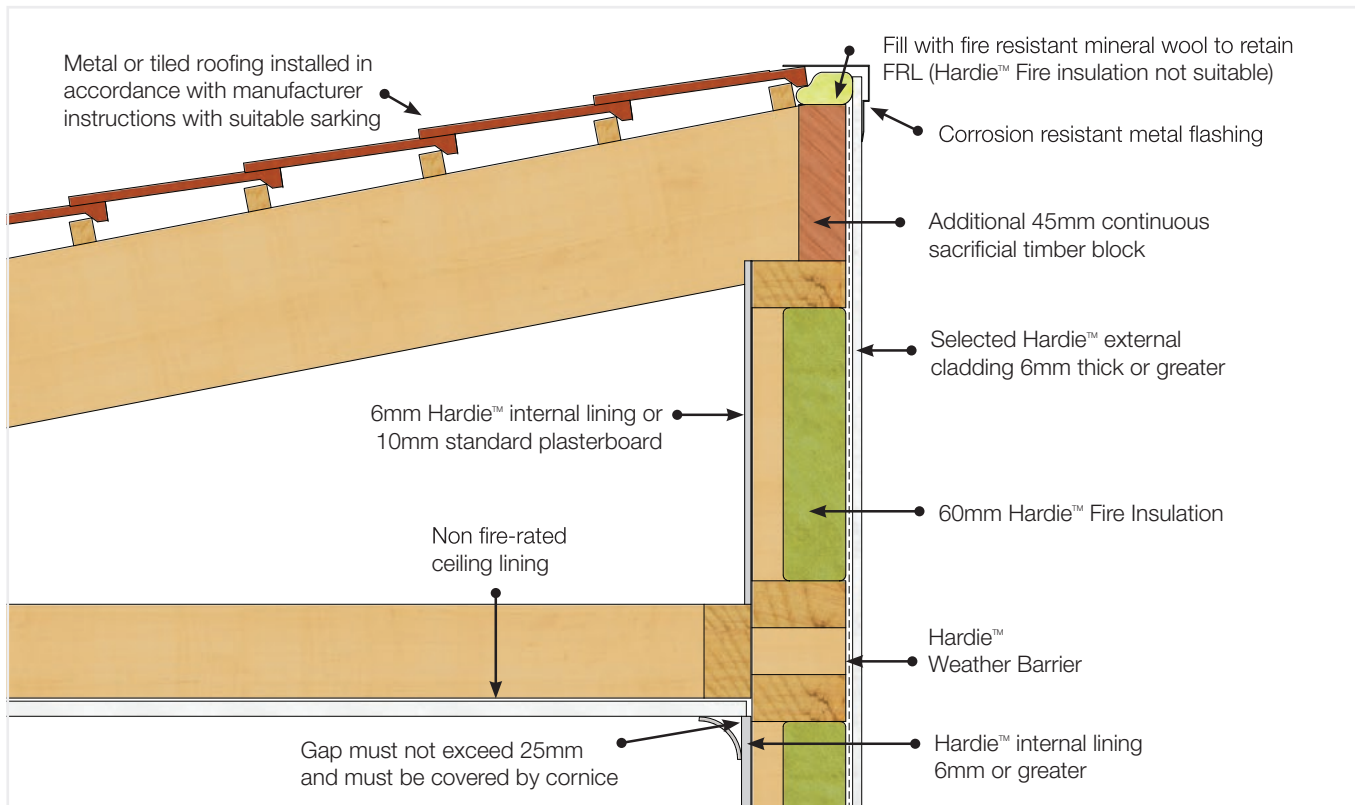

FIGURE 14 EXTERNAL BOUNDARY WALL TO PARAPET FRAMED ROOF

Addressed in page 16 of the FCO-3222J - Same configuration as Figure 16 (different truss orientation).

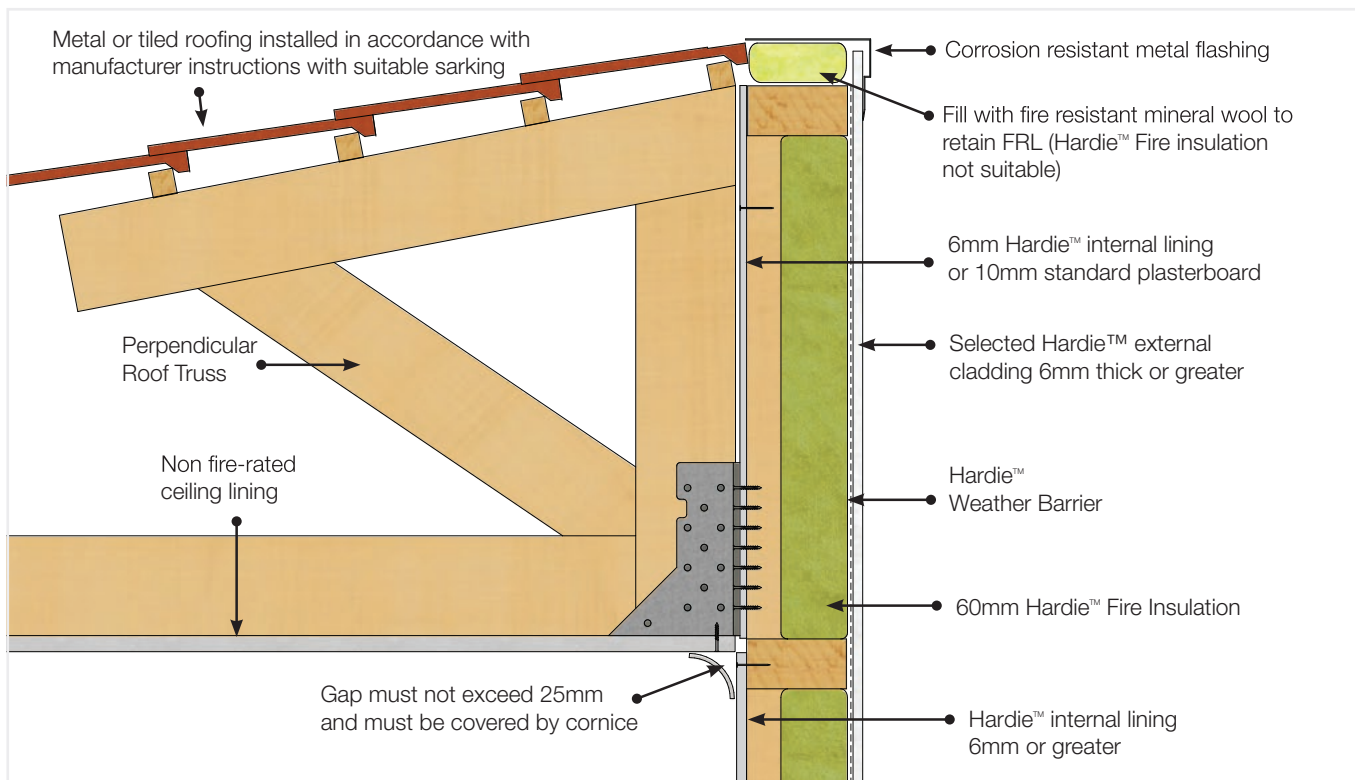

FIGURE 15 EXTERNAL BOUNDARY WALL TO PARAPET ROOF WITH PERPENDICULAR ROOF TRUSSES

WALL JUNCTIONS

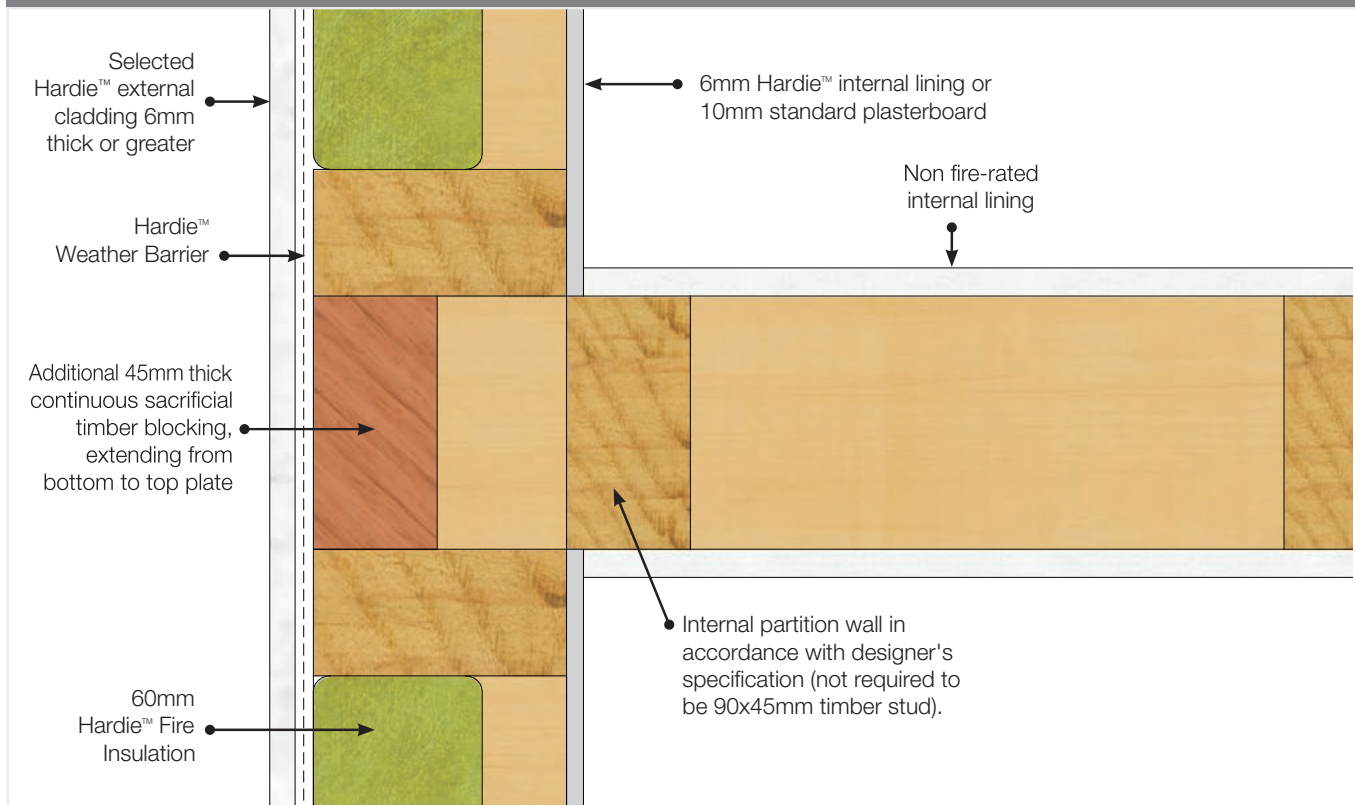

FIGURE 16 NON FIRE-RATED INTERSECTING FIRE-RATED BOUNDARY WALL

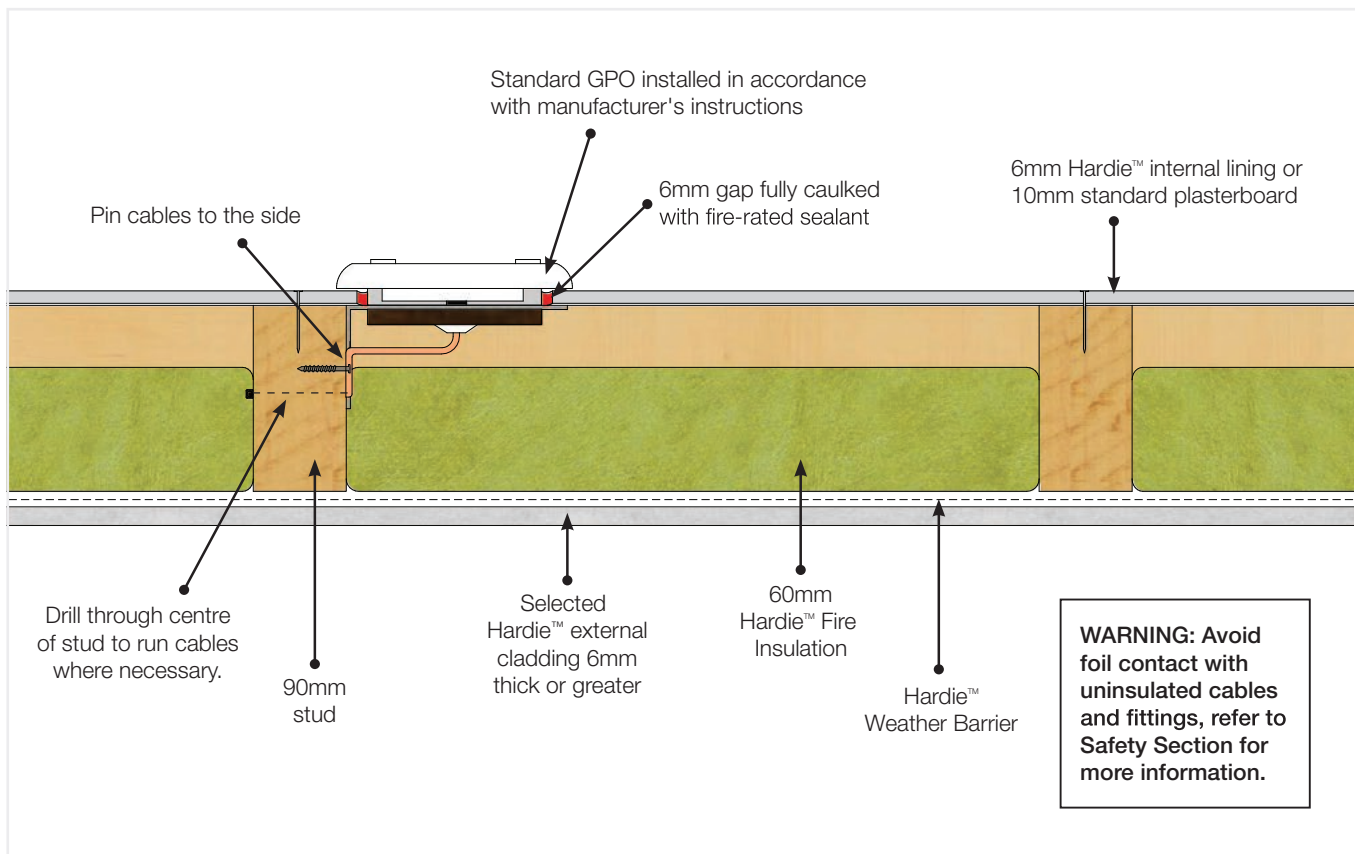

FIGURE 17 ELECTRICAL SERVICES (GPO/POWER POINTS) - SECTION FROM ABOVE

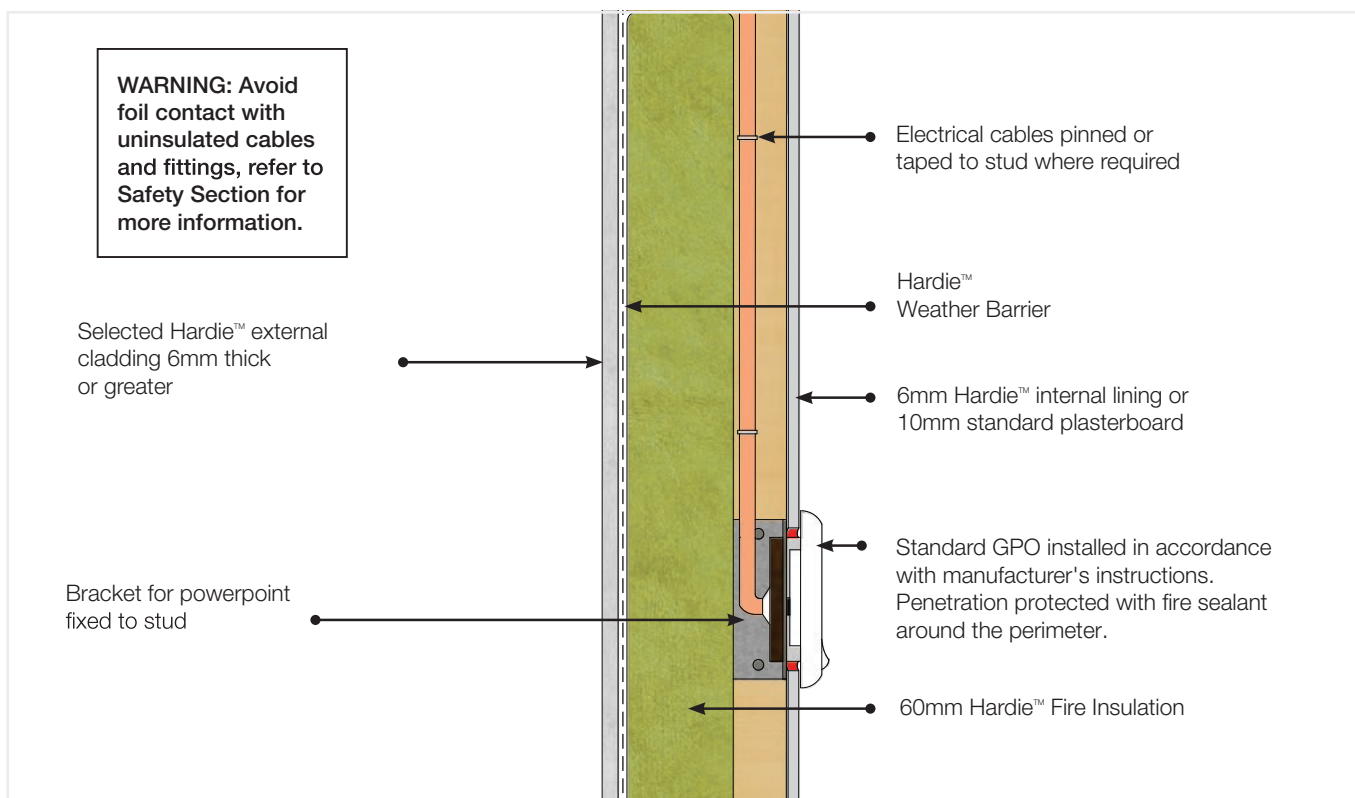

FIGURE 18 ELECTRICAL SERVICES (GPO/POWER POINTS) - SECTION FROM SIDE

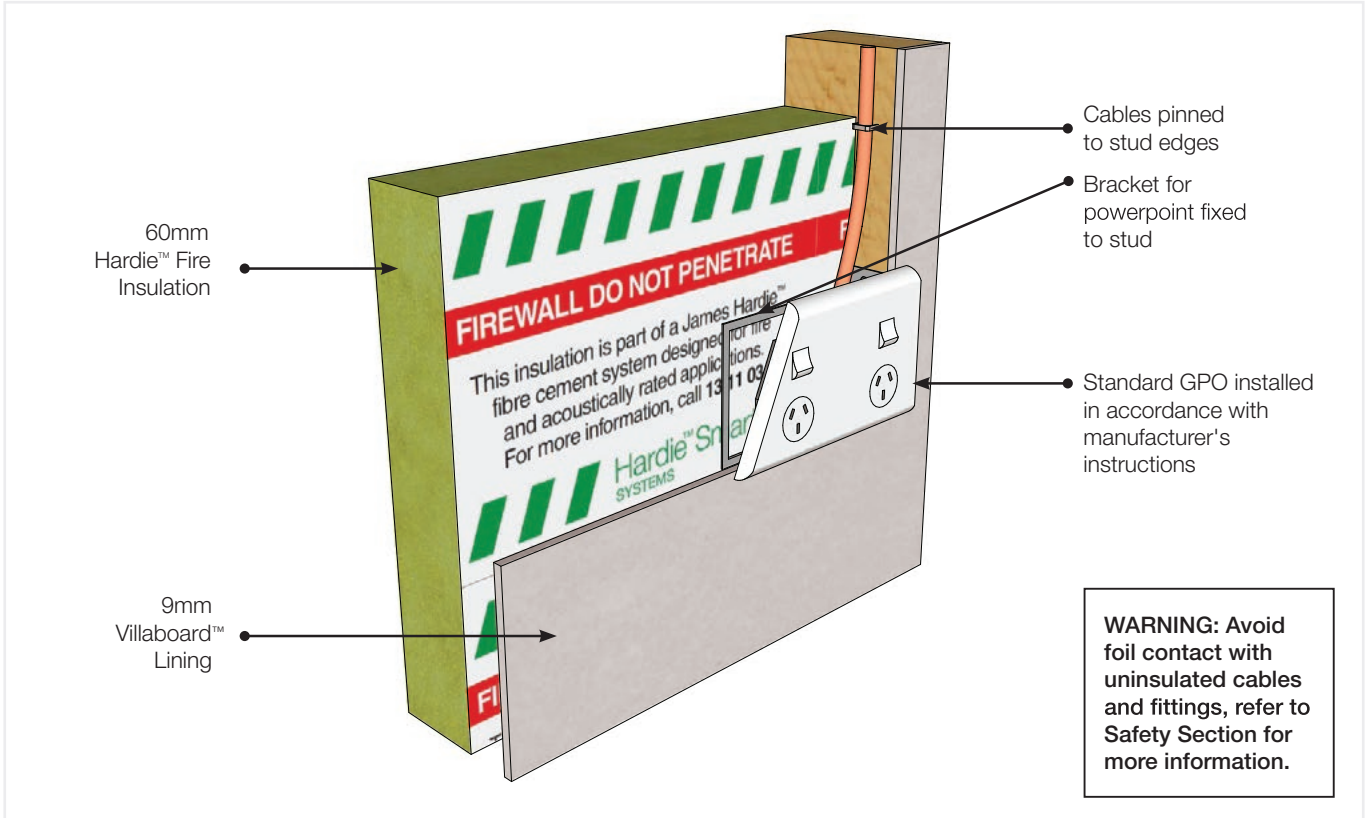

FIGURE 19 ELECTRICAL SERVICES (GPO/POWER POINTS) PERSPECTIVE

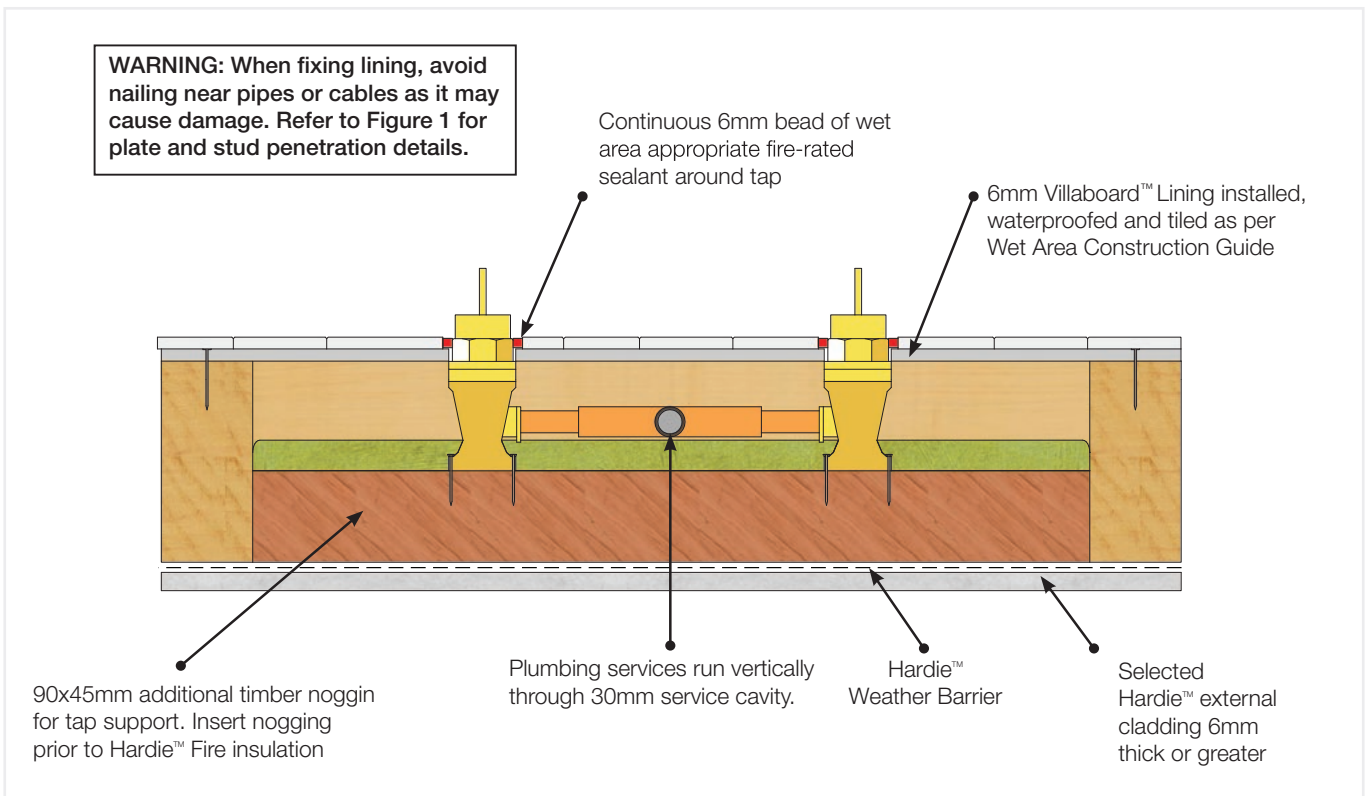

FIGURE 20 HOT/COLD PLUMBING TAPS - SECTION FROM ABOVE

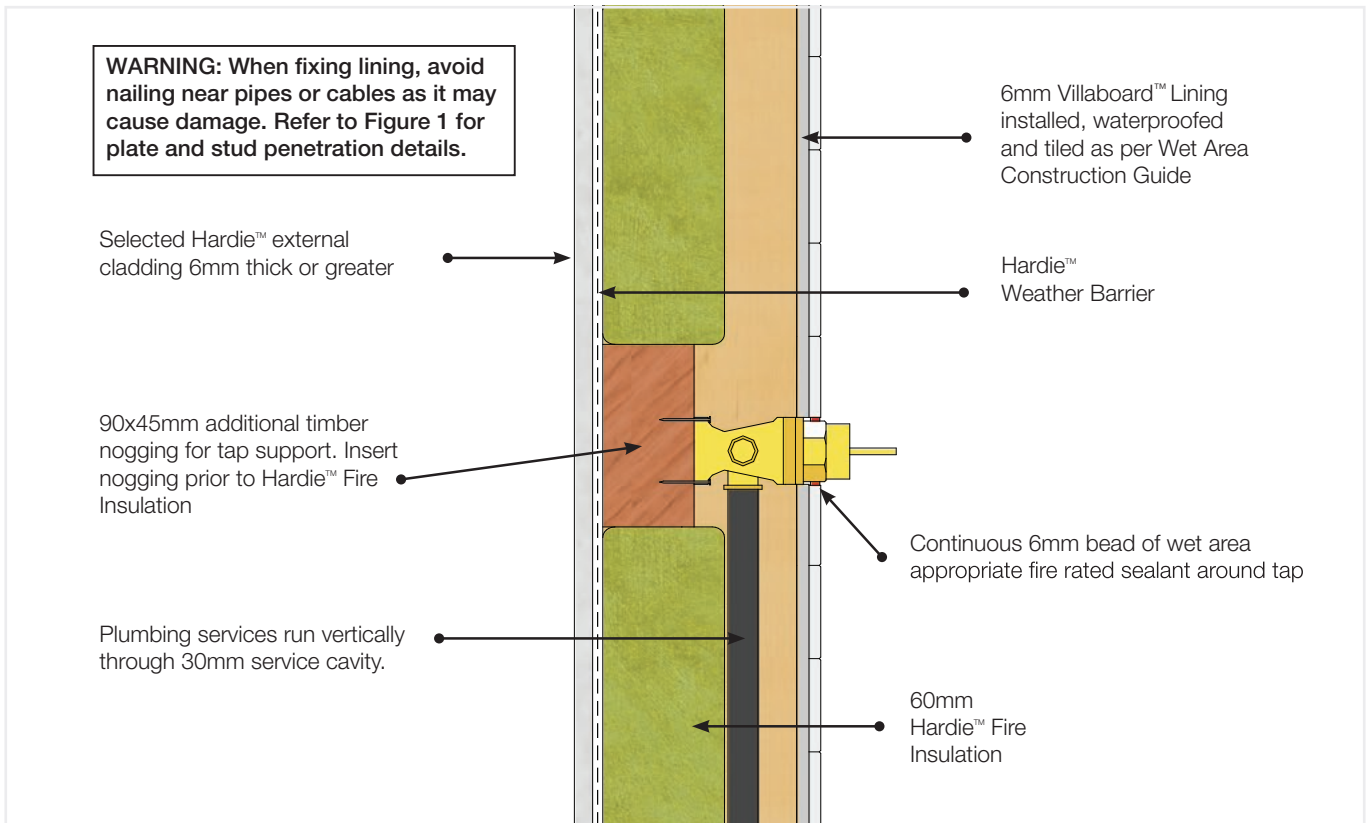

FIGURE 21 HOT/COLD PLUMBING TAPS - SECTION FROM SIDE

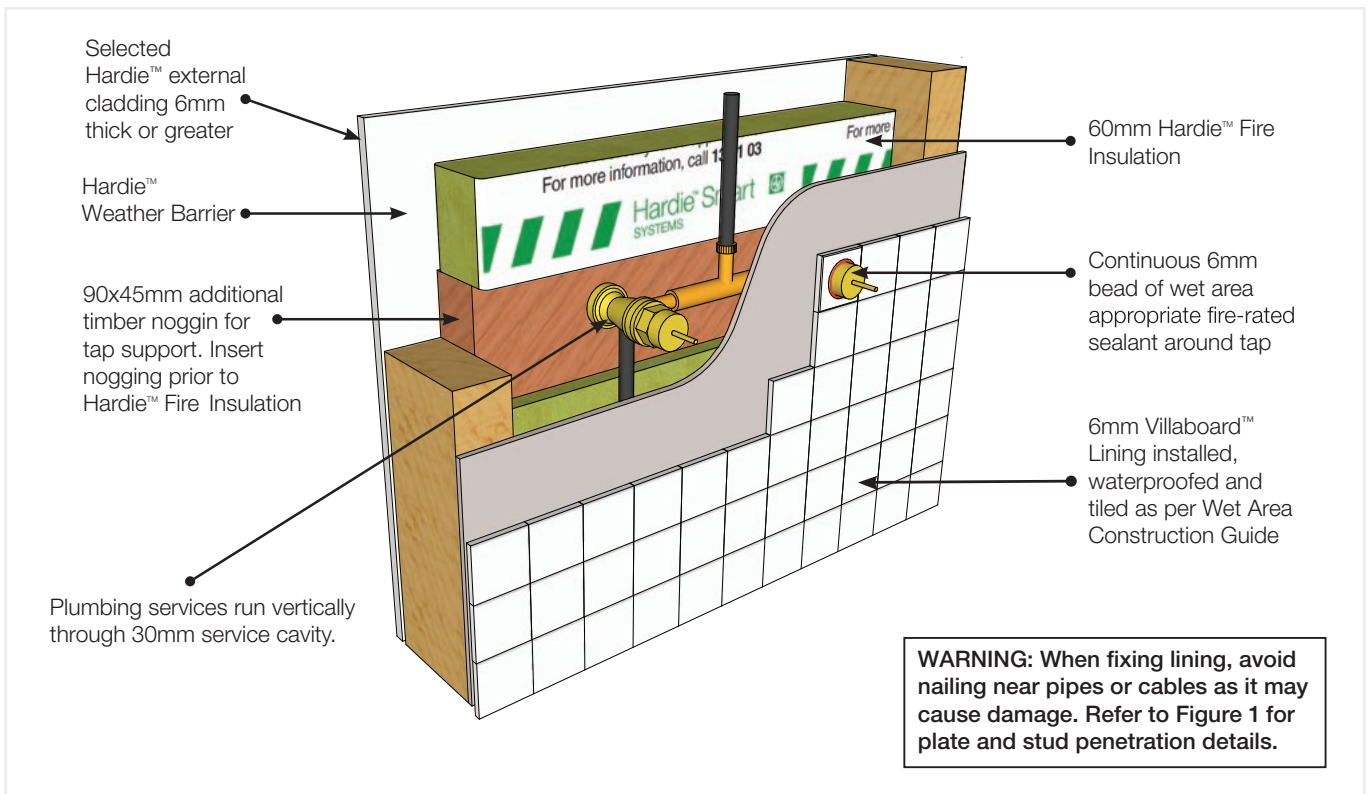

FIGURE 22 HOT/COLD PLUMBING TAPS - PERSPECTIVE

ONLINE TOOLS

Estimation tools, CAD details, and site specific documents are available via our specification website myhardies.jameshardie.com.au
For more information visit the website or Contact James Hardie on 13 11 03.

WARRANTY

Hardie™ Smart Wall System components supplied by James Hardie are backed by a Warranty.
The Warranty period will vary based on the specific system component.
For Warranty Terms & Conditions refer to www.jameshardie.com.au or Contact James Hardie on 13 11 03.

CODEMARK CERTIFICATION





**For information and advice
call 13 11 03 | [jameshardie.com.au](https://www.jameshardie.com.au)**

Australia November 2023

© 2023 James Hardie Australia Pty Ltd ABN 12 084 635 558
™ and ® denote a trademark or registered trademark owned by James Hardie Technology Limited.
Codemark® and Bostik® are trademarks or registered trademarks of their respective owners and are not owned by James Hardie Technology Limited.

