



 FRL 60/60/60
TWO WAY

 Rw + Ctr >50

 R3.22 - 3.51
m²k/W

 4.0 - 10 kN/m

Design Guide

Hardie™ Smart Intertenancy Wall System
Class 1 & 10a Timber Frame Building

SYSTEMS

Australia November 2023

Make sure your information is up to date.

When specifying or installing Hardie™ products, ensure that you have the current technical information and guides. If in doubt, or you need more information, visit jameshardie.com.au or Contact James Hardie™ on 13 11 03.



INDEX

- Introduction** **2**
- System specification** **3**
 - Intertency wall system 3
 - System performance 3
 - Alternative systems and performance 3
 - Main components 3
 - Other components 4
 - Tools 4
- Overview and applications** **5**
 - What is a intertenancy wall system? 5
 - Advantages 5
 - Minimum requirements 5
 - Applications 5
- Inspections and certification** **5**
- Safe work practices** **6**
 - Fibre cement 6
 - Hardie™ Fire Insulation 6
- Design considerations** **7**
 - General 7
 - Slab and footings 7
 - Fire resistance 7
 - Acoustic performance 7
 - Bracing performance 7
 - Thermal performance 7
 - Fastener type limitation 7
 - Coastal areas 7
 - Coatings & finishes 7
 - Roof cavity lining 7
 - Component installation 8
 - Component substitution 8
 - Structure and framing 8
 - Services and fixtures 11
- Installation sequence** **12**
- Details** **14**
 - Base details 14
 - Floor junctions 15
 - Steel posts 16
 - Roof junctions 19
 - Wall junctions 24
 - Control joints 27
- Online tools** **30**
- Warranty** **30**
- Codemark certification** **30**

INTRODUCTION

This guide contains product information, technical specification, construction details and design considerations for the Hardie™ Smart Intertency Wall System.

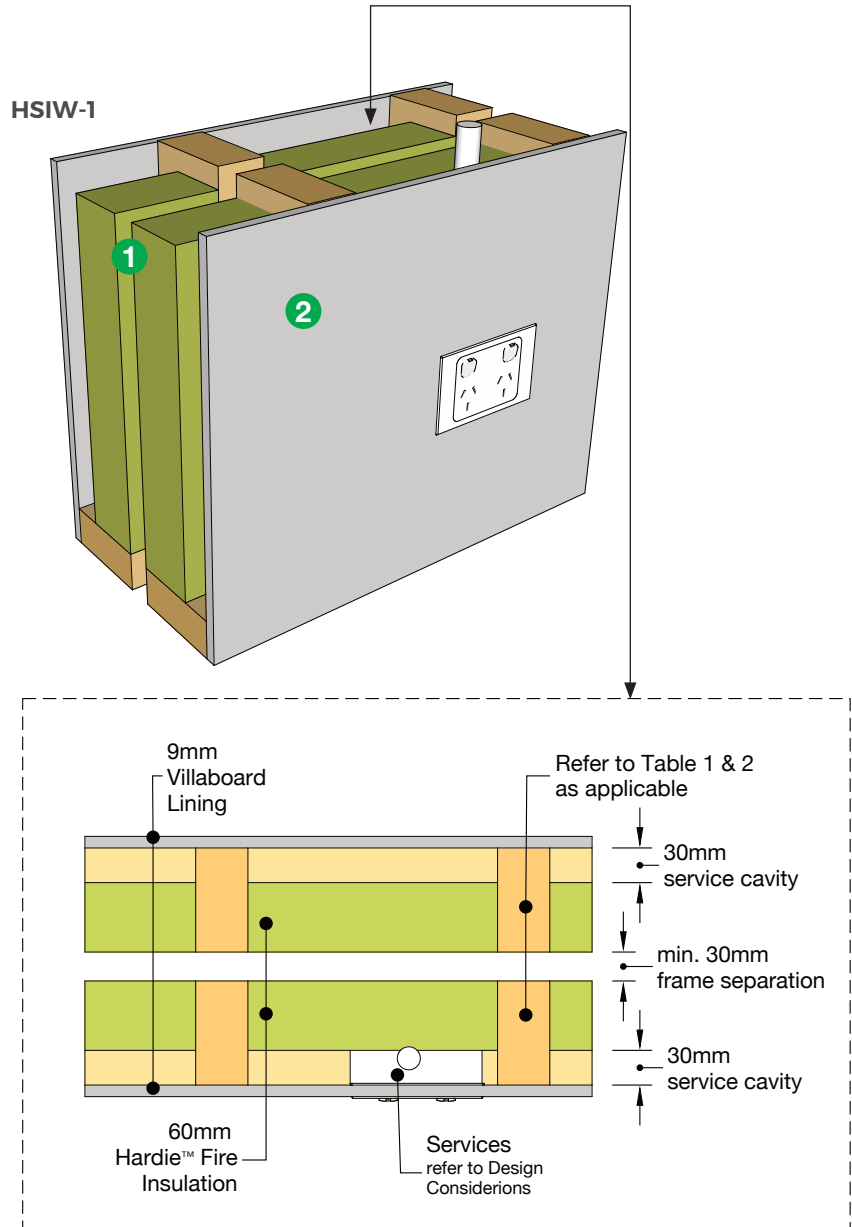

NOTE: The above is a common configuration of the system

SYSTEM SPECIFICATION

INTERTENANCY WALL SYSTEM

For separating walls in row housing.

HSIW-1 SYSTEM PERFORMANCE



FRL
60/60/60 minutes TWO WAY



Total R-value
3.22 - 3.51 m²k/W
Refer to the Thermal Performance section on Page 7 for further information.



Bracing
4.0 - 10kN/m
(depends on fixing method, refer to Design Considerations).



Acoustic Per Wall
60 R_w | 51 R_w+C_{tr}

ALTERNATIVE SYSTEMS AND PERFORMANCE

HSIW-2	FRL (min)	Acoustic (R _w R _w +C _{tr})
	60/60/60	63 54
Components		
Linings on both sides	6mm Villaboard™ lining 10mm plasterboard (min. 5.7kg/m ²)	
Insulation	60mm Hardie™ Fire Insulation	

HSIW-3	FRL (min)	Acoustic (R _w R _w +C _{tr})
	60/60/60	65 57
Components		
Linings on both sides	9mm Villaboard™ lining 10mm plasterboard (min. 5.7kg/m ²)	
Insulation	60mm Hardie™ Fire Insulation	

MAIN COMPONENTS

1

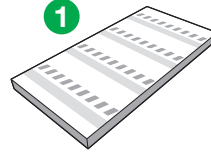

60MM HARDIE™ FIRE INSULATION

Mineral wool insulation specifically designed for use in fire applications with select Hardie™ Smart Systems.

Pack Size	7	
Size (mm)	Part No	Coverage (m ²)
560x1160x60	305903	5.1
420x1160x60	305902	3.8
420x1320x60	305909	4.3

Thickness (mm)	60
----------------	----

Material R-value (m ² .K/W)	1.7
----------------------------------------	-----

Density (kg/m ³)	80
------------------------------	----

2

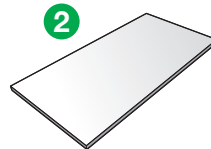

HARDIE™ INTERNAL LINING

Selected Hardie™ internal lining must be at least 9mm thick. To see our range of suitable internal products, visit jameshardie.com.au or Contact James Hardie™ on 13 11 03.

9mm Villaboard™ lining is a fibre-cement sheet with a recessed edge. Suitable for tiled and untiled internal wall applications in dry and wet areas.

VILLABOARD 9MM	Part No
Sizes (mm) 1200 x (2400, 2700, 3000, 3600) 1350 x 3000	See Villaboard™ lining manual

Mass (kg/m ²)	13.9
---------------------------	------

OTHER COMPONENTS

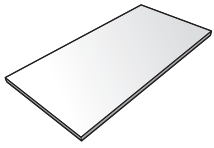

6MM VILLABOARD™ LINING

Used as a wall lining for roof cavities and for system variation HSIW-2.

Sizes (mm)

900 x (2400, 3000)
1200 x (1800, 2400, 2700, 3000, 3600, 4200)
1350 x (2400, 3000, 3600, 4200)

Part No

See
Villaboard™
lining manual

Mass (kg/m²)

8.3



FASTENERS

(NOT SUPPLIED BY JAMES HARDIE)

Fibre Cement Nail

for fixing Villaboard™ lining.

2.8 x 30mm min.

Min. Class 3 corrosion resistant fibre cement nail.

2.5 x 50mm gun nails are also suitable. Check with nail manufacturer for suitability.

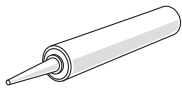

SEALANTS

(NOT SUPPLIED BY JAMES HARDIE)

Fire and Acoustic-Rated Sealant

Use Bostik FireBan One fire rated sealant or equivalent. If using an equivalent sealant it must be tested in accordance with AS 1530.4 and achieve a minimum 60 minute fire rating. Contact the relevant sealant manufacturer for more information.

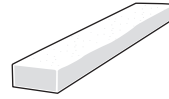

OTHER

(NOT SUPPLIED BY JAMES HARDIE)

Fire Resisting Mineral Wool

Used to seal cavities and maintain FRL at junctions of the selected wall system.

Please see Construction Details for applications. Refer to manufacturer for guidance on installation.

TOOLS



Reciprocating Saw, Utility Knife or Hand Saw for Cutting Hardie™ Fire Insulation

Used for cutting insulation when required.

Ensure to cut 5mm wider than required to ensure compression of insulation in the cavity.

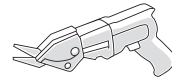

Tools For Fibre Cement

A suite of tools are available for cutting and handling Hardie™ fibre cement.

Please refer to James Hardie's Best Practice Guide for more information.

OVERVIEW AND APPLICATIONS

WHAT IS A INTERTENANCY WALL SYSTEM?

An Intertency wall is defined as a wall that is common to adjoining Class 1 buildings. This is also known as a ‘Separating Wall’ as per the National Construction Code (NCC).

Hardie™ Smart Intertency Wall system comprises a twin 90mm timber frame with a 30mm cavity separation insulated with 60mm Hardie™ Fire Insulation on both frames within the stud bays. Frames are lined with 9mm Villaboard™ lining on both sides (for other lining configurations refer to page 3).

The system’s fire performance is achieved by the combination of the timber frame, the Hardie™ Fire Insulation and Villaboard™ lining to achieve a Fire Resistance Level of 60/60/60 minutes while still allowing for services within a 30mm service cavity in each frame.

ADVANTAGES

- Does not require a central fire barrier installed between frames, allowing continuous construction,
- Significant time savings during frame construction when compared to central barrier systems,
- A small wall footprint of only 228mm width,
- Better risk management due to unique Fire Wall print on the insulation batts (avoid future damage),
- Allowance for 20mm diameter services without comprehensive fire protection measures.

MINIMUM REQUIREMENTS

The Hardie™ Smart Intertency Wall System is designed for common walls between tenancies in Class 1 and 10a developments (e.g. townhouses and terraces) requiring semi-detached construction. It is suitable for use in timber-framed buildings with a Fire Resistance Level (FRL) requirement of 60/60/60 minutes or less. For higher FRL requirements or other building types, please consult James Hardie.

APPLICATIONS

Some of the main applications are depicted below. These are based NCC Volume 2 and do not cover all applications and limitations, the designer must check all NCC requirements before specifying. If more information is required to assess suitability, please contact James Hardie.



FIGURE 1 HARDIE™ SMART INTERTENANCY WALL SYSTEM TYPICAL APPLICATIONS

INSPECTIONS AND CERTIFICATION

The Hardie™ Smart wall system may require inspection and certification by a third party to ensure the construction conforms to the relevant requirements of the NCC and local regulations. The inspections will typically be carried out by a certifier or surveyor. To assist in ensuring the wall system has been correctly built, James Hardie recommend

completing the Installation Checklist at the end of this Guide. We can also provide any relevant documentation, such as the relevant CodeMark certificate and test reports, to certifiers and surveyors upon request via our Engineering Solutions team on 13 11 03.

SAFE WORK PRACTICES

FIBRE CEMENT

Hardie products contain sand, a source of respirable crystalline silica.

May cause cancer if dust from product is inhaled. Causes damage to lungs and respiratory system through prolonged or repeated inhalation of dust from product.

During installation or handling, ensure to follow James Hardie's Best Practice Book and SDS for Hardie™ fibre cement products available at jameshardie.com.au.

HARDIE™ FIRE INSULATION

ELECTRICAL CONDUCTIVITY

Foil facings are conductive to electricity. Care must be taken when installing Hardie™ Fire Insulation in the proximity of electrical wiring and lighting fixtures. Avoid contact with uninsulated electrical cables and fittings. If required, Hardie™ Fire foil facing may be removed using a utility knife. Consult a qualified Electrician, or contact James Hardie for further information.

STORAGE AND HANDLING

Store in an internal dry area, out of direct sunlight and not exposed to chemicals. It must not be installed during an electrical storm and it must be installed in a dry state to a dry surface and protected from weather during transport and storage. Hardie™ Fire Insulation has not been designed to withstand prolonged direct exposure to the exterior elements. Ensure that the insulation is completely dry prior to fitting.

PROTECTIVE EQUIPMENT

Keep exposure to a minimum and minimise quantities kept in work areas. Avoid contact with eyes. When handling and installing Hardie™ Fire Insulation, to prevent irritation ensure you wear:

- Safety goggles/glasses conforming to AS/NZS 1336,
- Protective clothing such as gloves and long sleeve shirts and trousers,
- P1 or P2 respirators.

BEFORE INSTALLATION

- You must turn the mains power 'Off' before entering the workspace. If in doubt, you must consult a licensed electrician.
- Care and safety measures must be followed when working in areas that contain live electrical wiring.
- Defective electrical cables, terminals or any other electrical wiring must be repaired by the relevant specialist prior to installation.
- Ensure workspace has adequate and ample ventilation. If working in confined spaces, it is recommended to use a M class or higher vacuum or other suitable dust extractors.
- Before entering workspace, complete a risk assessment inspection to identify and manage hazards including but not limited to electrical, site access and ventilation.

CUTTING

It is recommended to cut outdoors. If cutting indoors, please ensure that workspace is properly ventilated or M class or higher vacuum/dust extractors are used.

1. Position cutting station so wind will blow dust away from the user or others in working area.
2. Use either a hand saw or a reciprocating saw.

DISPOSAL

Discard any waste pieces of Hardie™ Fire Insulation in accordance with your local council guidelines. Dispose of the material in such a manner to prevent exposure and escape.

FURTHER HEALTH AND SAFETY INFORMATION

For more information refer to the Hardie™ Fire Insulation SDS available at jameshardie.com.au.

DESIGN CONSIDERATIONS

GENERAL

All design and construction must comply with the appropriate requirements of the NCC and other applicable regulations and standards. The specifier or other party responsible for the project must ensure that the details in this specification are appropriate for the intended application and that additional detailing is performed for specific design or any areas that fall outside the scope of this specification.

SLAB AND FOOTINGS

The slab and footings on which the building is situated must comply with AS 2870 'Residential Slabs and Footings – Construction' and the requirements of the NCC.

FIRE RESISTANCE

NCC Volume Two, H3D2 requires separating walls to maintain an FRL of 60/60/60 minutes. Hardie™ Smart Systems have been assessed by the CSIRO Division of Building Construction and Engineering and the Building Research Association of New Zealand (BRANZ) in accordance with the principles of AS1530.4 (FCO-3222-Rev L).

ACOUSTIC PERFORMANCE

The acoustic values provided are based on testing conducted by CSIRO and RMIT. Systems used in building construction are tested under laboratory conditions to establish their sound insulation characteristics. The method of measurement is described in AS1191 'Acoustics – Method for Laboratory Measurement of Airborne Sound Transmission Loss of Building Partitions'. 3.5.2 'Acoustic Modelling'.

Based on the test results indicated above, acoustic modelling for Hardie™ Smart Wall System variations was undertaken by Renzo Tonin Acoustics Pty Ltd. For more information on acoustic performance in buildings, please refer to James Hardie's Fire and Acoustic-Rated walls Application Guide and the NCC.

BRACING PERFORMANCE

For two sided systems i.e. comprising of both Hardie™ external cladding and internal lining products of ≥6mm in thickness, the bracing capacity is typically 4 kN/m for plain timber framing and standard fixing methods.

The capacity may be increased to a range of 6-10 kN/m for other fixing methods and anchor rods of 12mm diameter. For more information and specification, the designer must refer to James Hardie's Structural Bracing Application Guide (designed in accordance with AS 1684 'Residential Timber Framed Construction'). James Hardie's Structural

Bracing Application Guide contains fixing details and bracing capacity for Hardie™ sheet bracing and other fibre cement cladding. All design capacities quoted are Ultimate Limit State (ULS) figures and have been certified by consulting engineers, Cardno (NSW). Pty Ltd.

THERMAL PERFORMANCE

This guide outlines certified modelled total R-Values for Hardie™ Smart Wall Systems. Use this information as part of the input data required in energy efficiency assessments, described in Part H6 of the NCC 2022 Vol 2.

The Total R-values for common systems are in accordance with AS/NZS 4859.2:2018 Thermal Insulation Materials for Buildings - Part 2: Design.

TABLE 1

R-VALUE PER WALL		
Stud Spacing (mm)	R-Value (Winter)	R-Value (Summer)
600	3.51	3.32
450	3.39	3.22

1. The above published Total R values for the above building system configurations were independently assessed in accordance with AS/NZS 4859.2:2018 Thermal insulation materials for buildings. Part 2: Design.
2. Timber frame results take the effects of thermal bridging into account.
3. 90x45mm timber frame, 2400mm wall height and noggins spaced at 1200mm centers.
4. Systems assessed by e3k New Products Design & Development (Report 080520)

FASTENER TYPE LIMITATION

Brad nails and/or adhesive fixings are not recommended in fire and acoustic-rated systems. Please refer to the respective lining or cladding for alternative fixing methods.

COASTAL AREAS

In areas within 1km of a coastal area, areas subject to salt spray and other corrosive environments, Class 4 fasteners must be used. All other areas require a minimum Class 3 fastener. Fasteners must be fully compatible with all other materials that they are in contact with to ensure the durability and integrity of the assembly. Contact the fastener manufacturer for more information.

COATINGS & FINISHES

Refer to the respective Hardie™ internal lining installation manual for coating and/or tiling requirements. Please refer to the coating manufacturer for suitability and specific requirements.

ROOF CAVITY LINING

In the roof cavity, 6mm Villaboard™ Lining may be used instead of 9mm Villaboard™ Lining. Additionally, Hardie™ Top Coat, Base Coat and finishing coatings are not required to maintain FRL and acoustic performance. Ensure Villaboard™ Lining joints are butt hard against each other.

COMPONENT INSTALLATION

60mm HARDIE™ FIRE INSULATION

Must be used as the frame cavity infill and must be compressed 5mm minimum in both vertical and horizontal directions (i.e. batt size must be at a minimum 5mm wider and longer than frame stud bay). Avoid joints in insulation batts, if present, all gaps must be filled with compressed Hardie™ Fire Insulation.

Position batts flush with the stud face in the cavity. A string line may be used for alignment.

HARDIE™ INTERNAL LINING

Villaboard™ Lining must be installed in accordance with the current Villaboard™ Lining installation instructions. Refer to System Variations on Page 3 for alternative lining options.

OTHERS

For other components not supplied by James Hardie ensure to follow the instructions set out in this guide and the respective manufacturer's recommendations.

COMPONENT SUBSTITUTION

Hardie™ fibre cement products and components such as Hardie™ Fire Insulation and Hardie™ Weather Barrier must be as specified in the system.

No statement of performance will be provided by James Hardie when alternative products are used.

STRUCTURE AND FRAMING

NCC Section H1D6 requires timber framing to be designed and constructed in accordance with AS1684 suite which defines the minimum requirements for compliance including, but not limited to maximum of three storeys, spans, cantilevers, maximum wall heights, timber grades, timber cross-sections, lateral restraint, bracing, racking and axial capacity. The specifier or other party must ensure that any details outside the scope of the AS1684 suite is engineered to comply with the relevant structural performance provisions of the NCC.

In addition to the above, the following table and details in this guide provide further structural constraints and conditions to maintain the fire resistance level (FRL) of the wall system. For any applications outside the scope of the tables below, contact the Engineering Solutions team on 13 11 03.

MATERIAL

Seasoned timber only. Timber used for house construction must have the level of durability appropriate for the relevant climate and expected service life. Must use minimum MGP10 grade timber in accordance with AS1748, or LVL with equivalent strength, stiffness and density properties, manufactured in accordance with AS/NZS 4357.0. Reference AS1684 'Residential Timber Framed Construction'.

TABLE 2

LOADBEARING WALLS		
Max Stud Height* (mm)	Min Stud Size (mm)	Stud Load Capacity (kN/stud)
2700	90x35	3.1
	90x45	4.3
3000	90x35	3.1
	90x45	4.3
3300	90x35	2.9
	90x45	3.7
3600	90x45	2.9
3900	90x70 (2@90x35)	3.5
4200	90x90 (2@90x45)	3.6

* In accordance with Figure 2 Framing Configuration diagram.

TABLE 3

NON-LOADBEARING WALLS	
Max Stud Height (mm)	Min Stud Size (mm)
3600	90x35
4200	90x45
4500	90x90 (2@90x45)

STRUCTURAL CAPACITY

The load bearing capacities of the timber-framed walls must be in accordance with AS1684 and AS1720. Note that studs and joists should be aligned with minimum offset, or the load diverted by structural blocking or other method, in accordance with relevant timber codes and standards.

STUD SPACING

600mm maximum. Check whether you require closer stud spacings for your site wind pressures and tile weight (where applicable). ^See Table 2 Structural Capacity Table.

Hardie™ Fire Insulation sizes have been optimised for 45mm studs at 600mm centres and 35mm studs at 450mm centres, cutting may be required otherwise.

NOGGING FOR LOAD BEARING WALLS

Minimum 90mm deep. Installed flat in accordance with Figure 2 Framing Configuration Diagram

Maximum 1200mm spacing

NOTE: It is recommended noggings installed in line instead of staggered to facilitate insulation installation.

CANTILEVERED FLOORS

Cantilevered floors maximum span need to be designed in accordance with 'AS1684.2 Residential timber-framed construction'. Please refer to your Structural Engineer or qualified person for further design analysis.

STUD DRILLING

Where the stud is to be penetrated horizontally to allow services to pass between stud bays, only 1 in every 5 studs may be drilled a maximum of 25mm in diameter 10mm from the edge. Any larger or additional penetrations must *not* be located within the middle third of the stud height as per Figure 2 Framing Configuration diagram, and may require reduced stud spacing, or thicker studs in accordance with Table 2 Structural Capacity table.

TOLERANCE

Ensure frame is square and work from a central datum line. Frames must be straight and true to provide a flush face to receive the sheeting. A suggested maximum tolerance of between 3mm and 4mm in any 3000mm length will give best results.

SACRIFICIAL TIMBER

Sacrificial timber blocking (also known as char blocking) is used in addition to the standard timber framing to protect structural members from fire. Sacrificial timber is differentiated by red hatching in the Construction Details section of this guide.

Sacrificial timber should have a minimum density of 550kg/m³, and be pine or LVL of minimum 45mm thickness. Blocks are to be arranged so that they are continuous or, additional blocking installed in front of any joints.

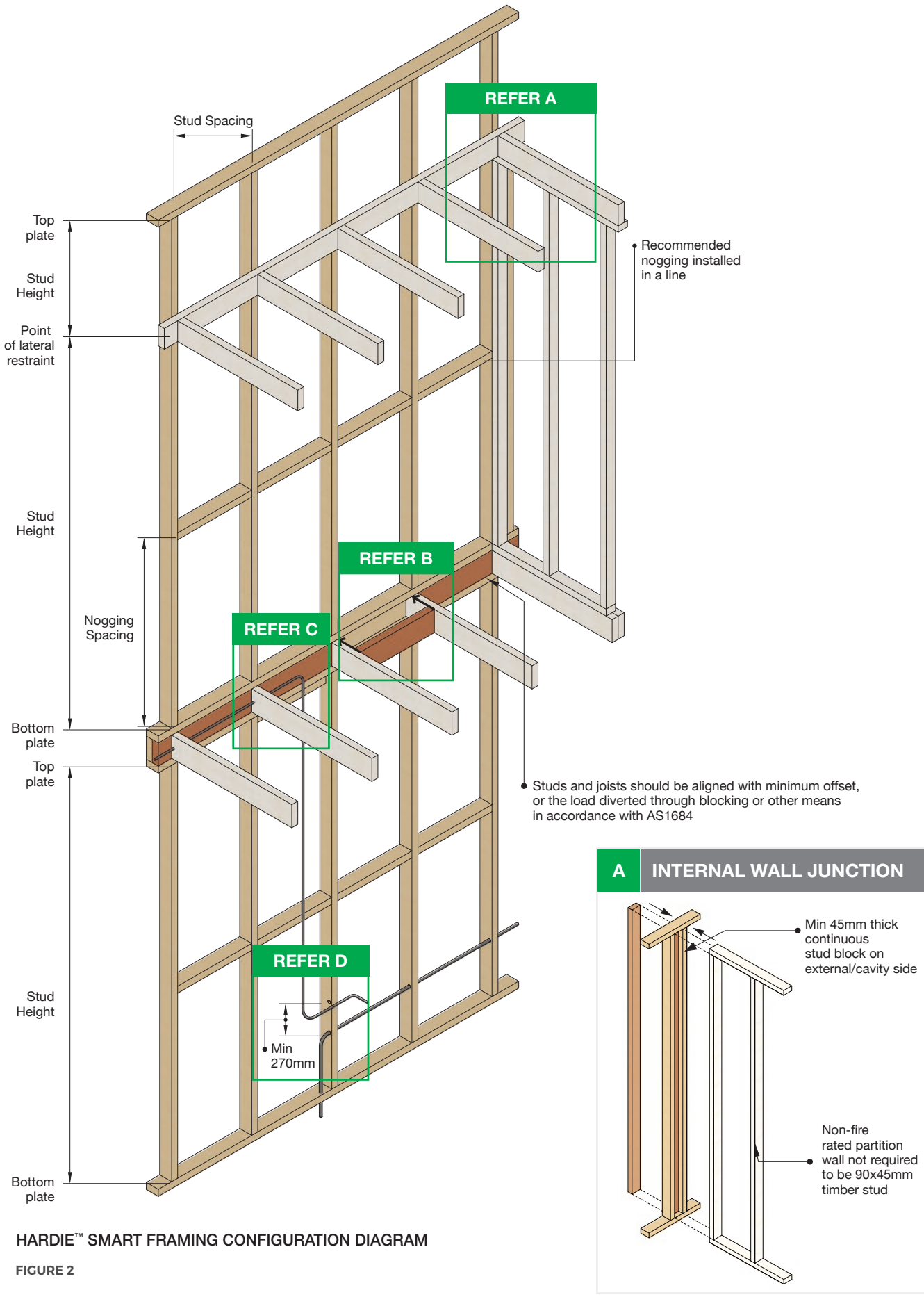

HARDIE™ SMART FRAMING CONFIGURATION DIAGRAM
FIGURE 2

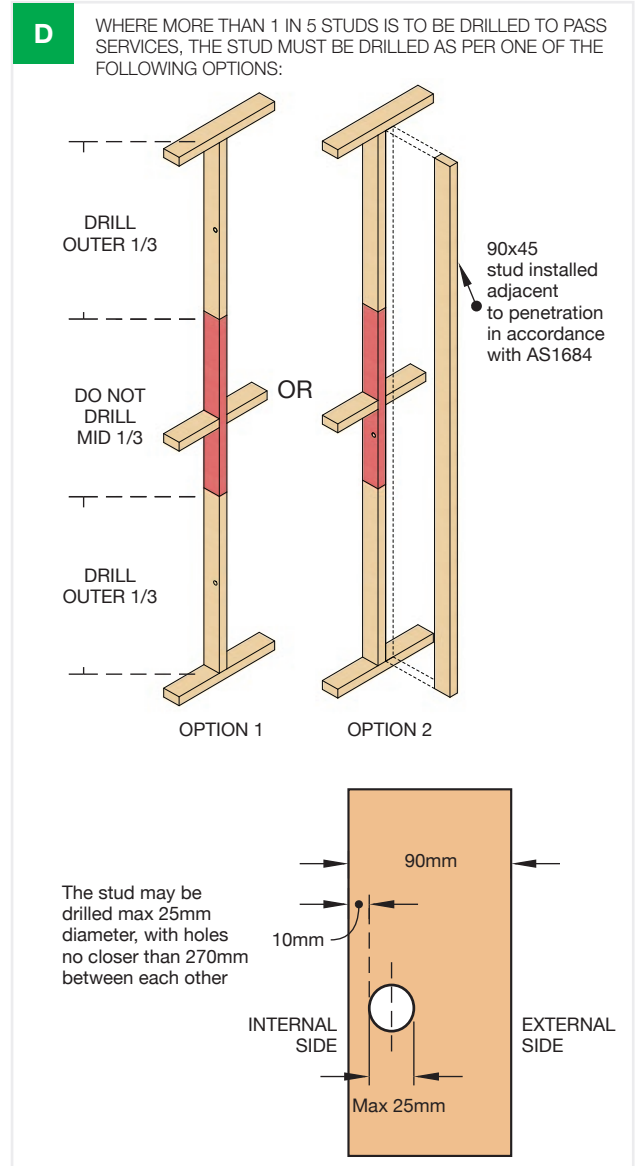
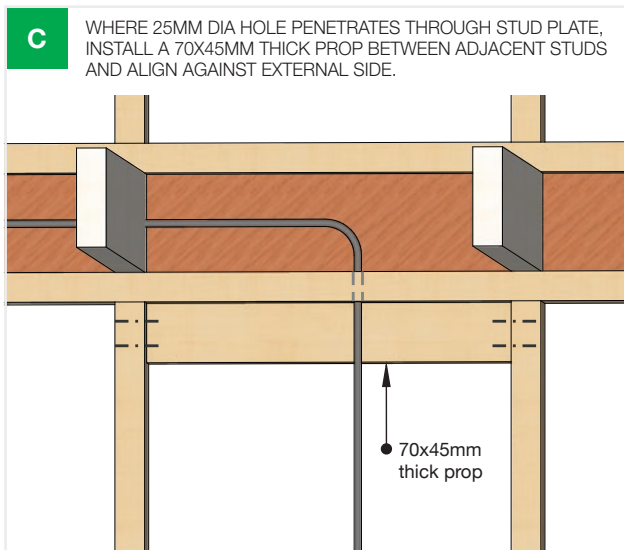
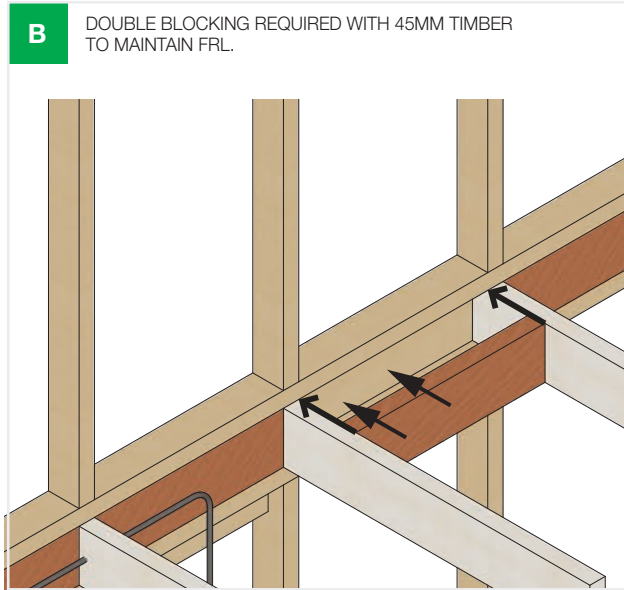

SERVICES AND FIXTURES

The service cavity is designed to allow services to be run vertically from the ceiling into the wall. Where services run horizontally through the studs to pass between bays, refer to Figure 2 Frame Configuration diagram under Design Considerations and Figure 28-33 for installation guidelines.

Services may only be run in the service cavity between the insulation and the lining (i.e. must not exceed 20mm deep).

WARNING: When fixing lining, avoid nailing near pipes or cables as it may cause damage.

ELECTRICAL CABLES

Electrical cables may be run within the service cavity. Refer to Figures 28-30.

PLUMBING AND ELECTRICAL CONDUITS

Pipes with a diameter up to 20mm may be run in the service cavity as per Figure 2. Any larger pipes must be relocated to non-fire rated partitions. For taps and other details, refer to Figures 31-33.

AIR-CONDITIONING

Pipes with an outside diameter up to 20mm and carrying non-flammable refrigerants may be run inside the service cavity.

WALL FIXTURES

When fixing brackets, cabinets, shelves or any other fixture that requires the wall to carry a load, they must be fixed to the framing member (i.e. studs) and must not rely solely on the lining.

INSTALLATION SEQUENCE

1 FIRST STOREY FRAMES

Erect first storey frames of all connected homes.

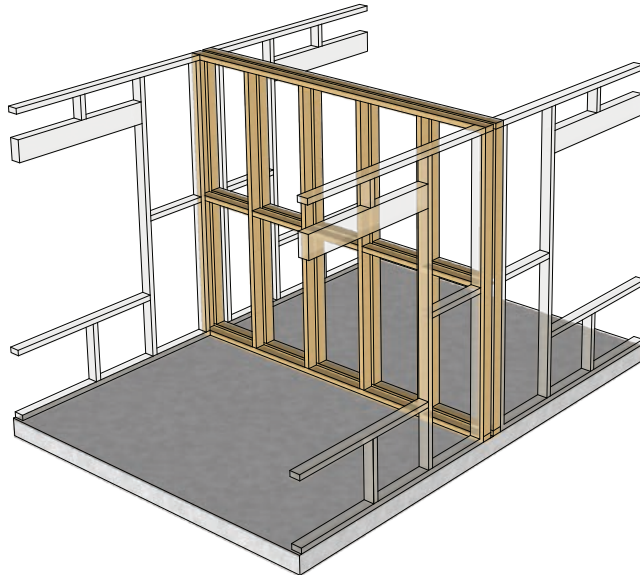

2 FIRE SAFETY ON FIRST FLOOR

45mm thick sacrificial timber bearer required both sides above top plate to maintain FRL. Refer to Construction Details for options.

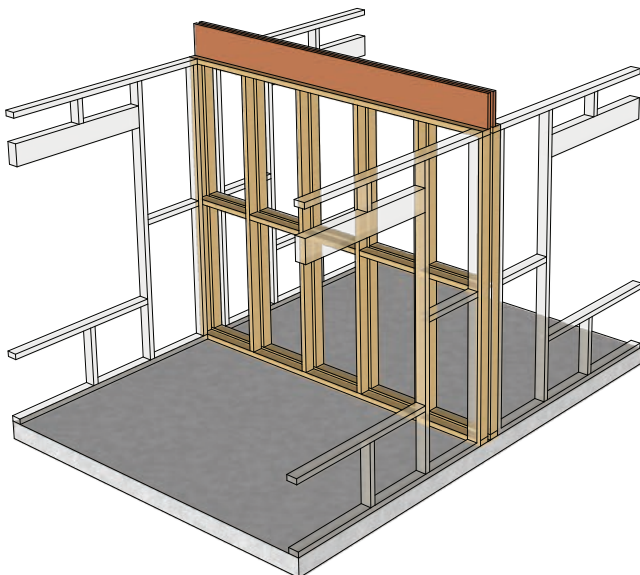

3 BUILD UPPER STOREYS

Where required, erect upper storey.

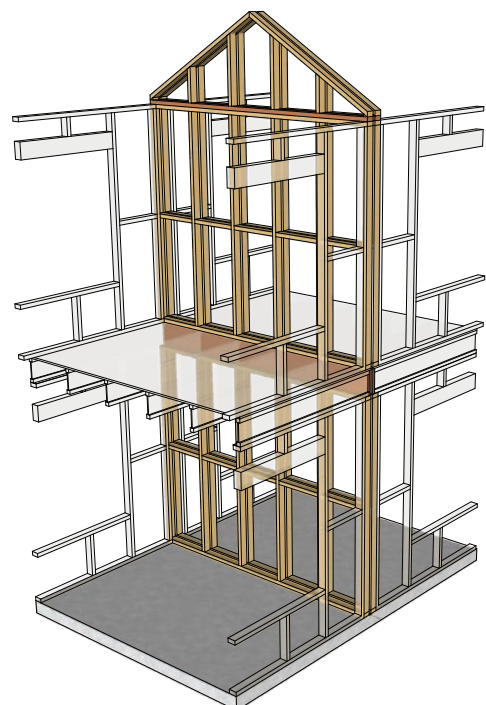

4 ROOF FIRE SAFETY

Build roof. Install Hardie™ Fire Insulation and Villaboard™ Lining to roof extension to fire rate ceiling space. Refer to Construction Details for options.

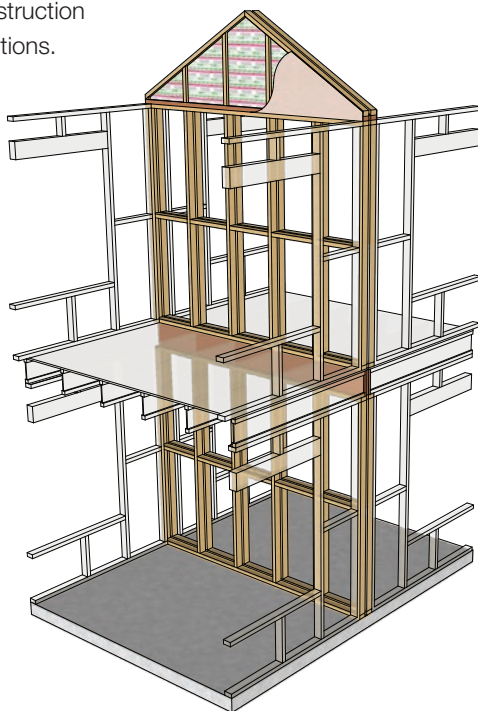

5 INSULATION

Run electrical cables and install Hardie™ Fire Insulation in all wall areas. **Ensure 5mm compression.**

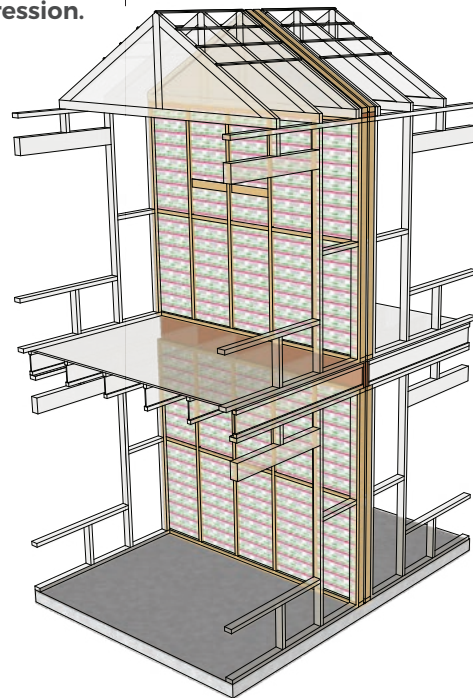

6 SERVICES AND LINING

Install all services followed by Villaboard™ Lining to both sides of the wall.

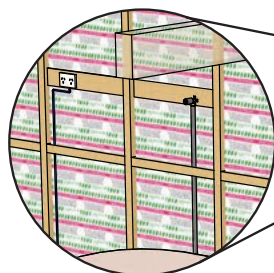

Refer to Figure 31-33 for pipe installation guidelines

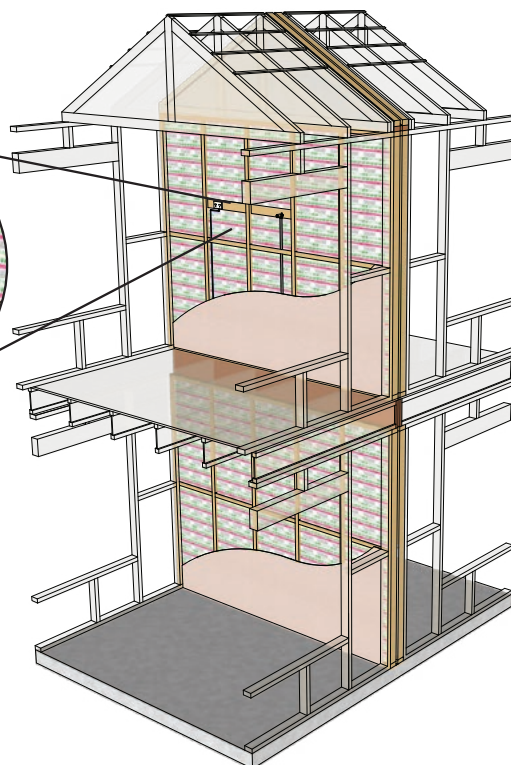

DETAILS

BASE DETAILS

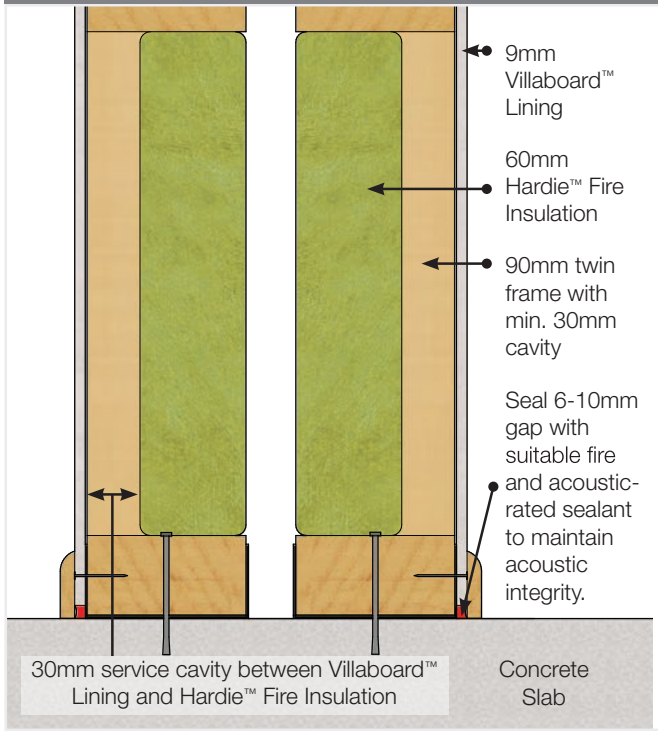

FIGURE 3 HARDIE™ SMART INTERTENANCY WALL SYSTEM BASE TO SLAB DETAIL

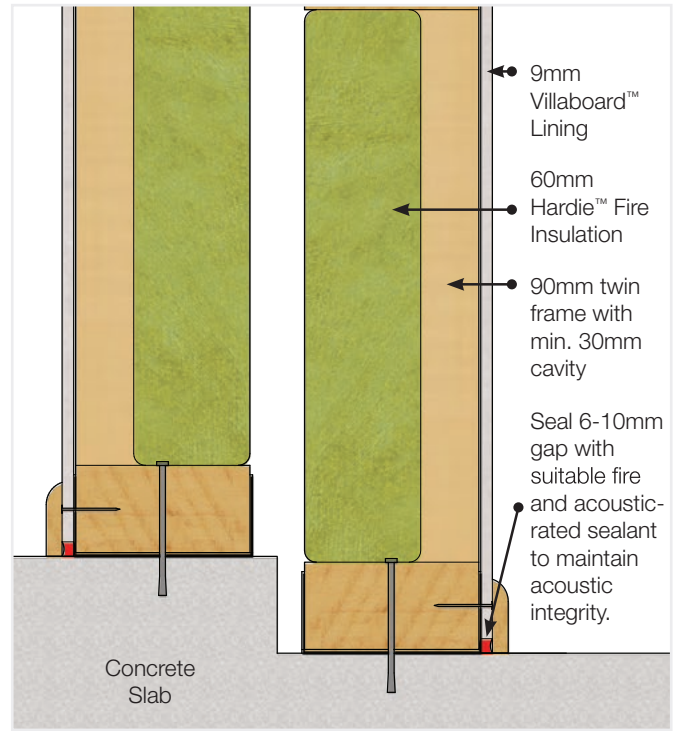

FIGURE 4 HARDIE™ SMART INTERTENANCY WALL SYSTEM BASE TO STEPPED SLAB DETAIL

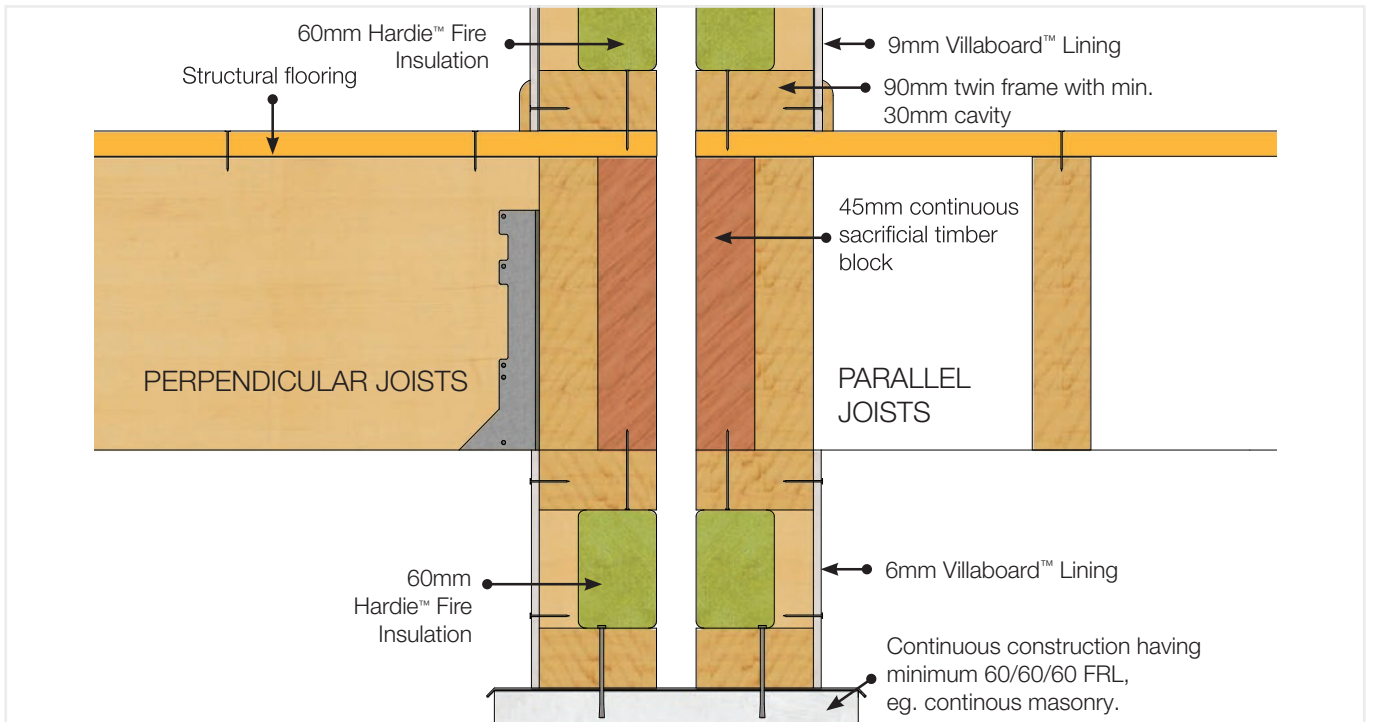

FIGURE 5 HARDIE™ SMART INTERTENANCY WALL SYSTEM WITH SUSPENDED GROUND FLOOR

FLOOR JUNCTIONS

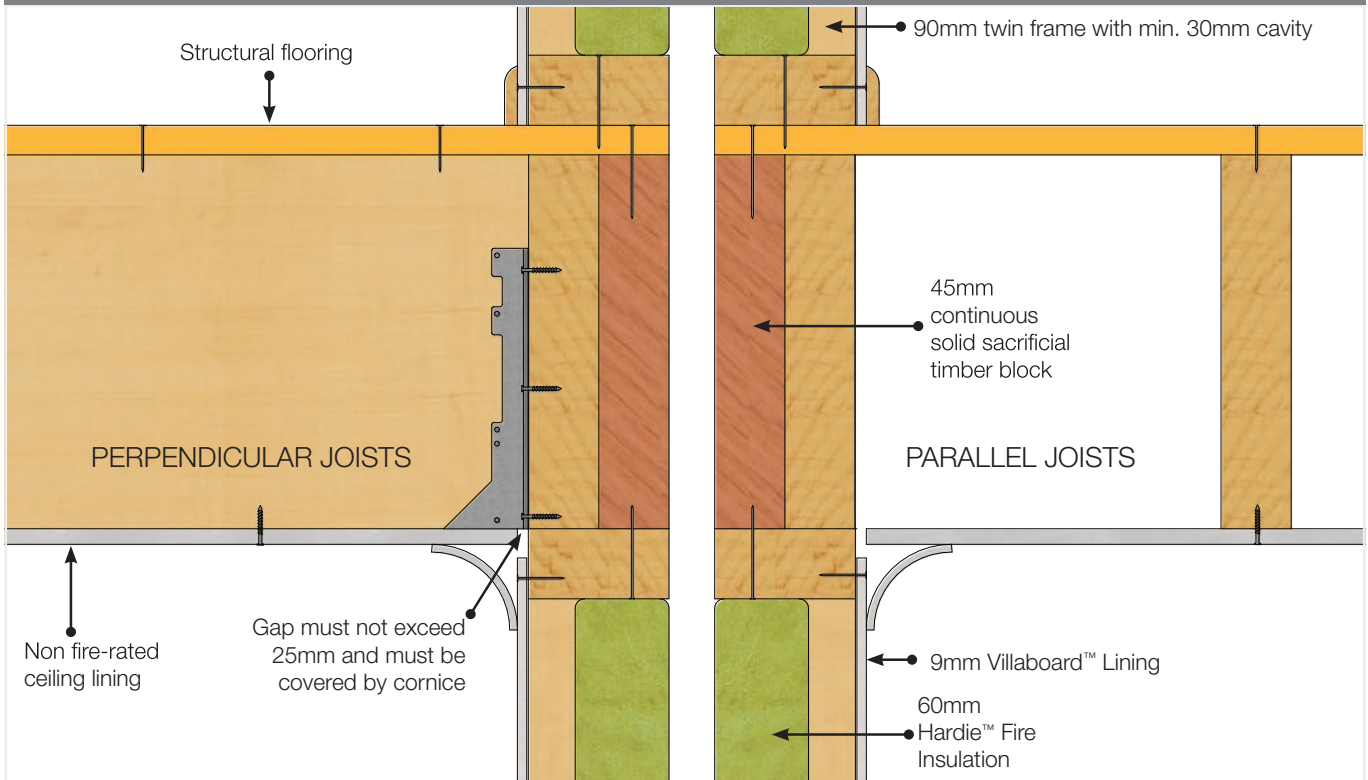

FIGURE 6 HARDIE™ SMART INTERTENANCY WALL SYSTEM DISCONTINUOUS WALL FLOOR JUNCTION (OPTION 1)

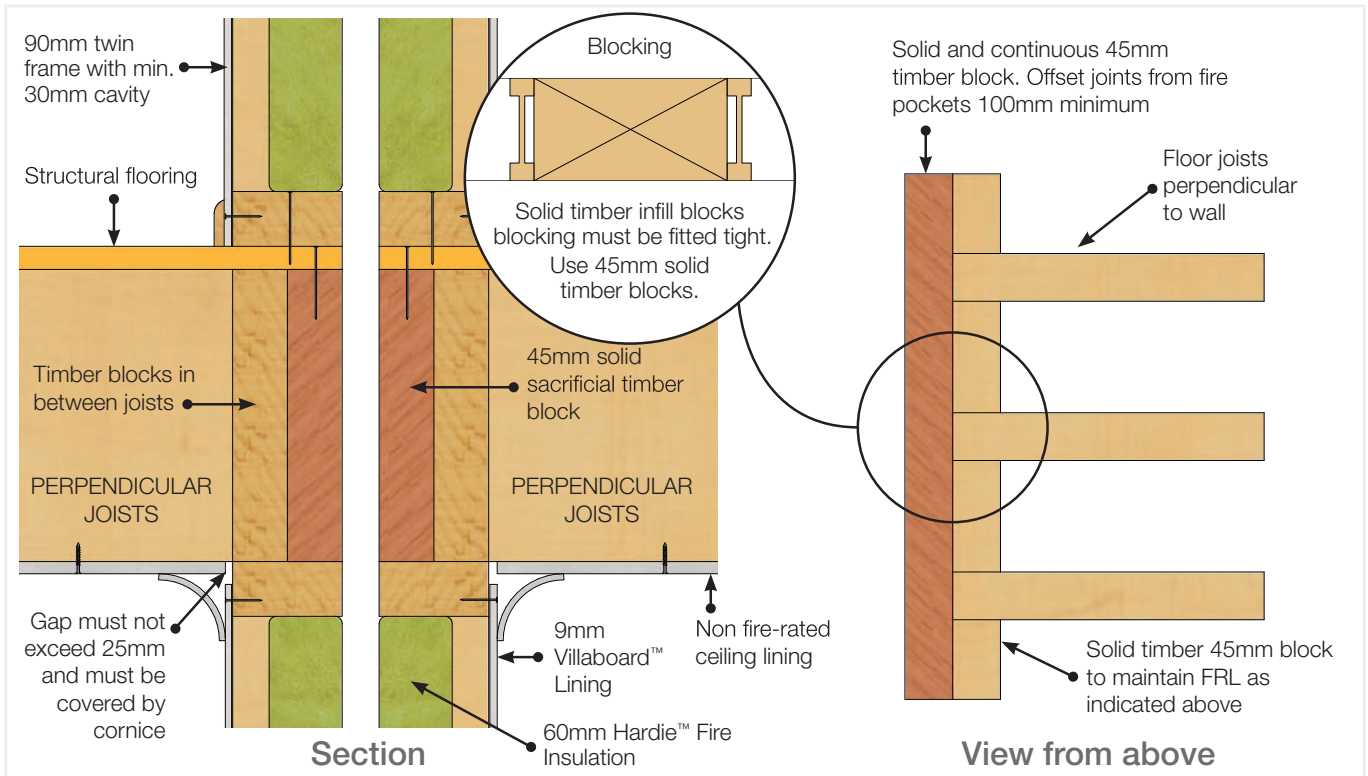

FIGURE 7 HARDIE™ SMART INTERTENANCY WALL SYSTEM DISCONTINUOUS WALL FLOOR JUNCTION (OPTION 2)

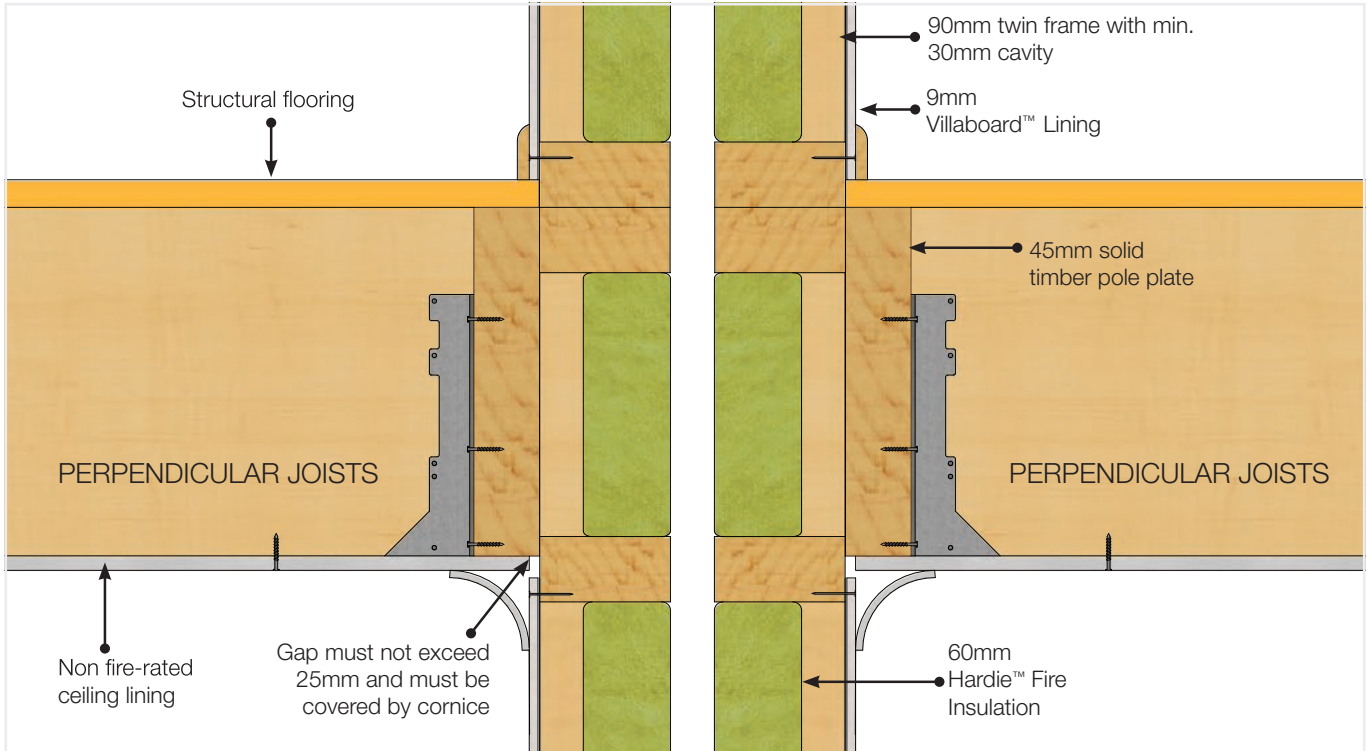

FIGURE 8 HARDIE™ SMART INTERTENANCY WALL SYSTEM CONTINUOUS WALL FLOOR JUNCTION

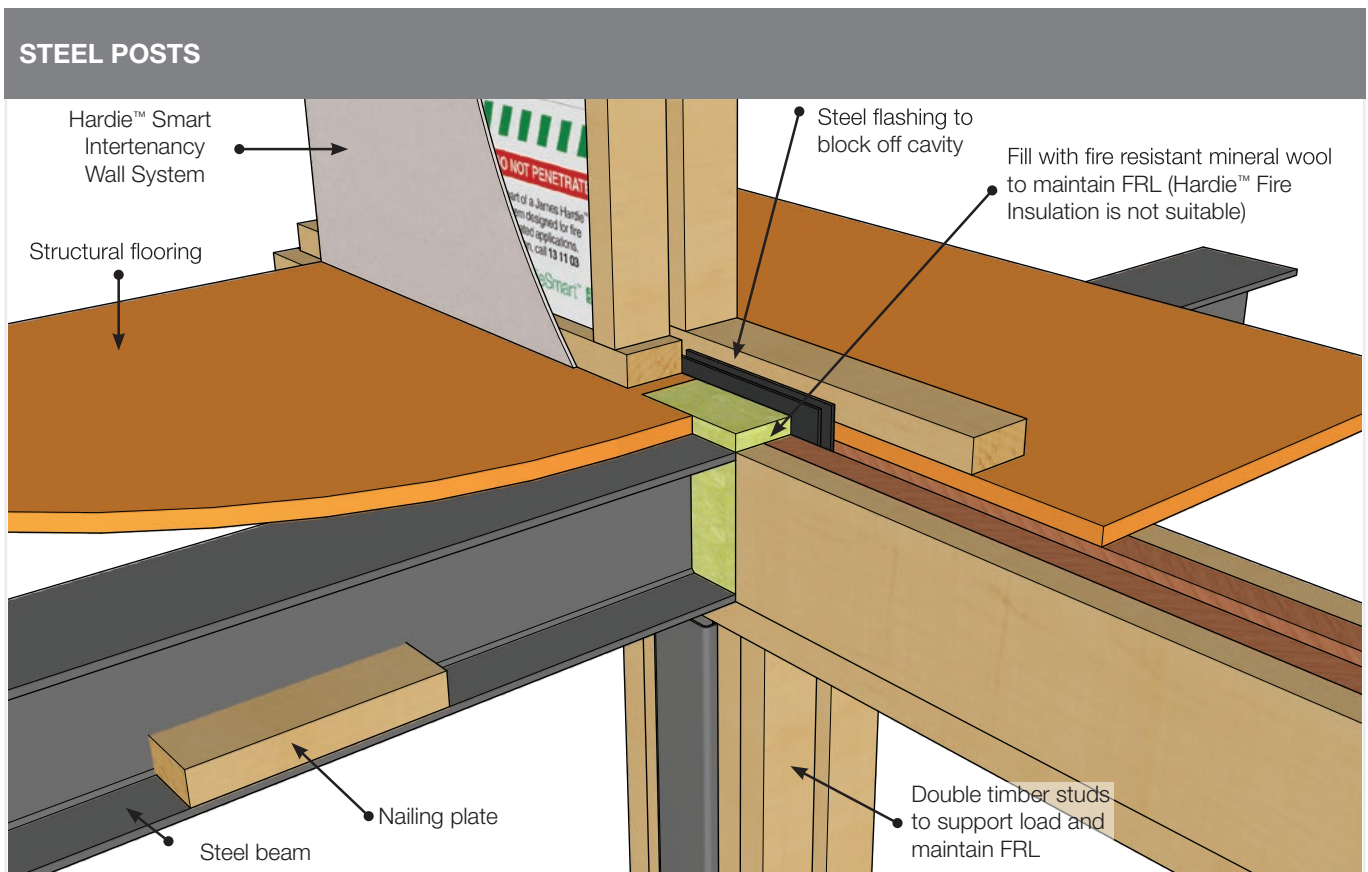

FIGURE 9 STEEL BEAM AND COLUMN PERPENDICULAR TO FIRE WALL - PERSPECTIVE VIEW

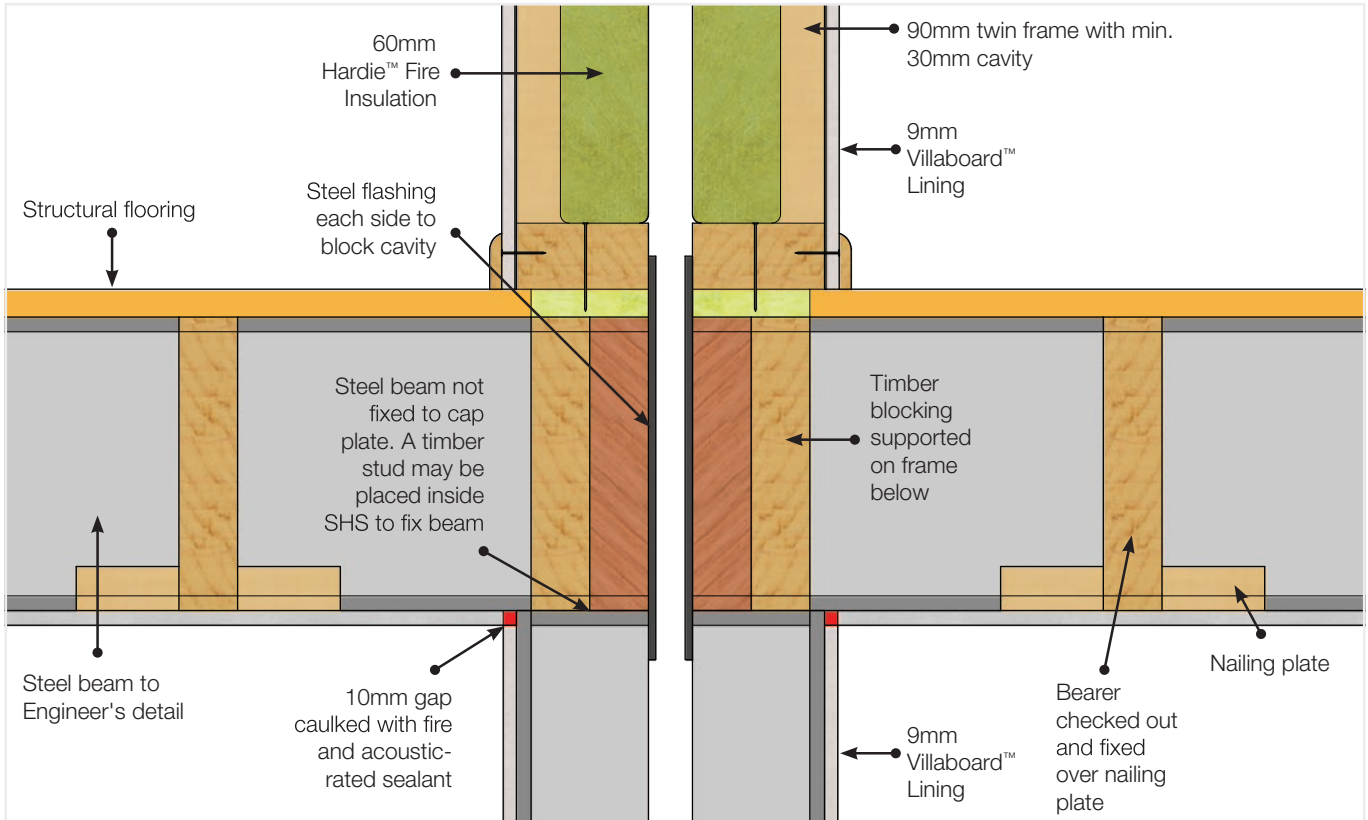

FIGURE 10 STEEL BEAM AND COLUMN PERPENDICULAR TO FIRE WALL - SECTION VIEW

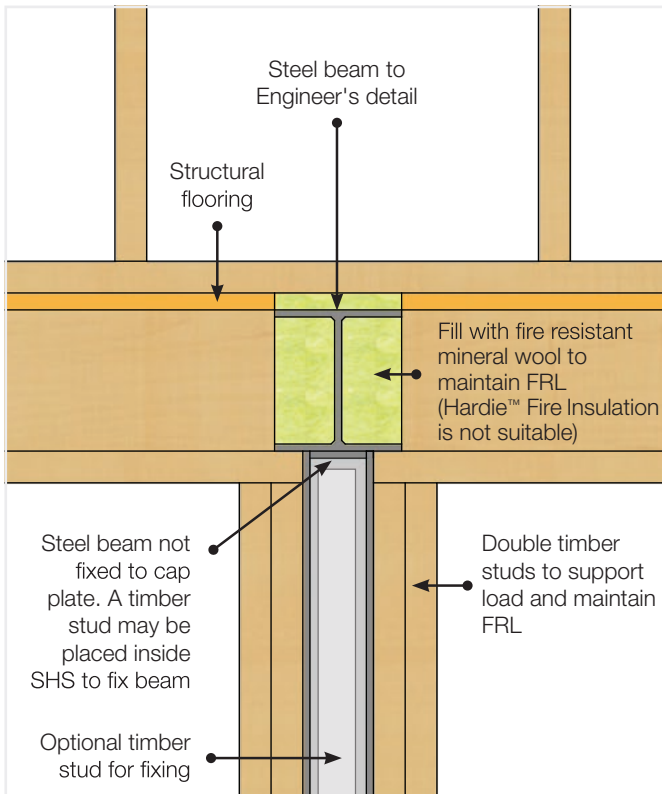

FIGURE 11 STEEL BEAM AND COLUMN PERPENDICULAR TO FIRE WALL - ELEVATION VIEW

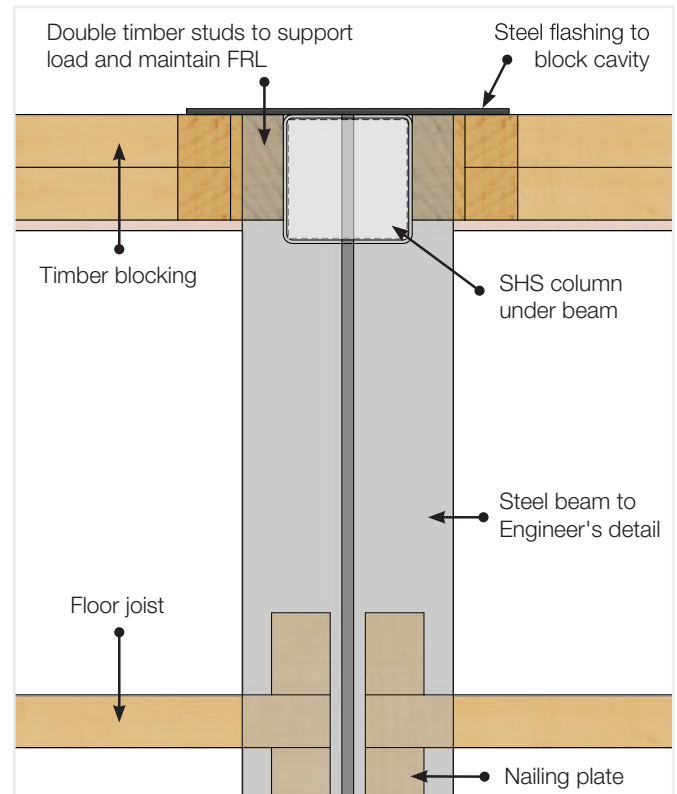

FIGURE 12 STEEL BEAM AND COLUMN PERPENDICULAR TO FIRE WALL - PLAN VIEW SHOWING ONE WALL LEAF

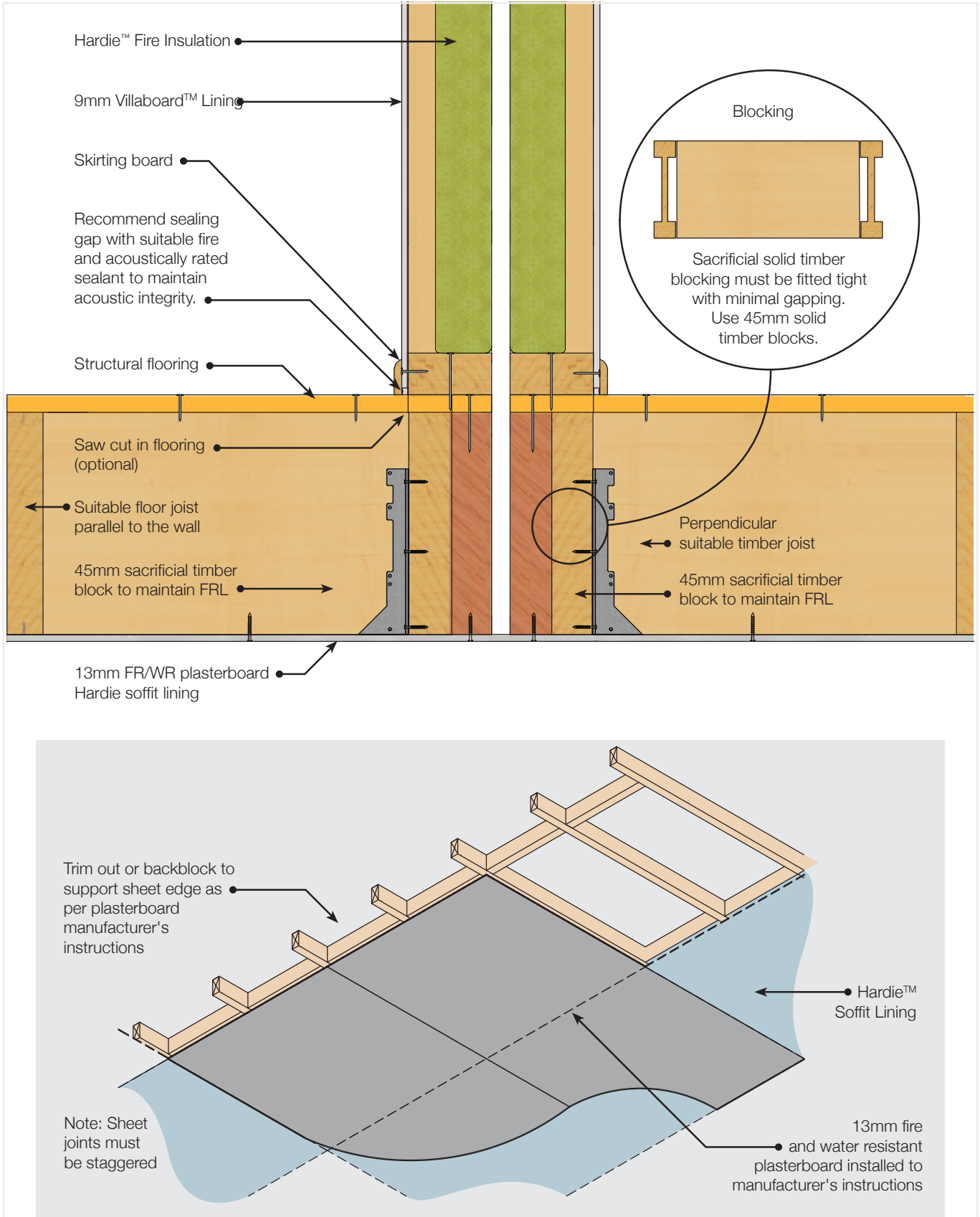

FIGURE 13 HARDIE™ SMART INTERTENCY WALL SYSTEM WITH CANTILEVERED FLOOR

ROOF JUNCTIONS

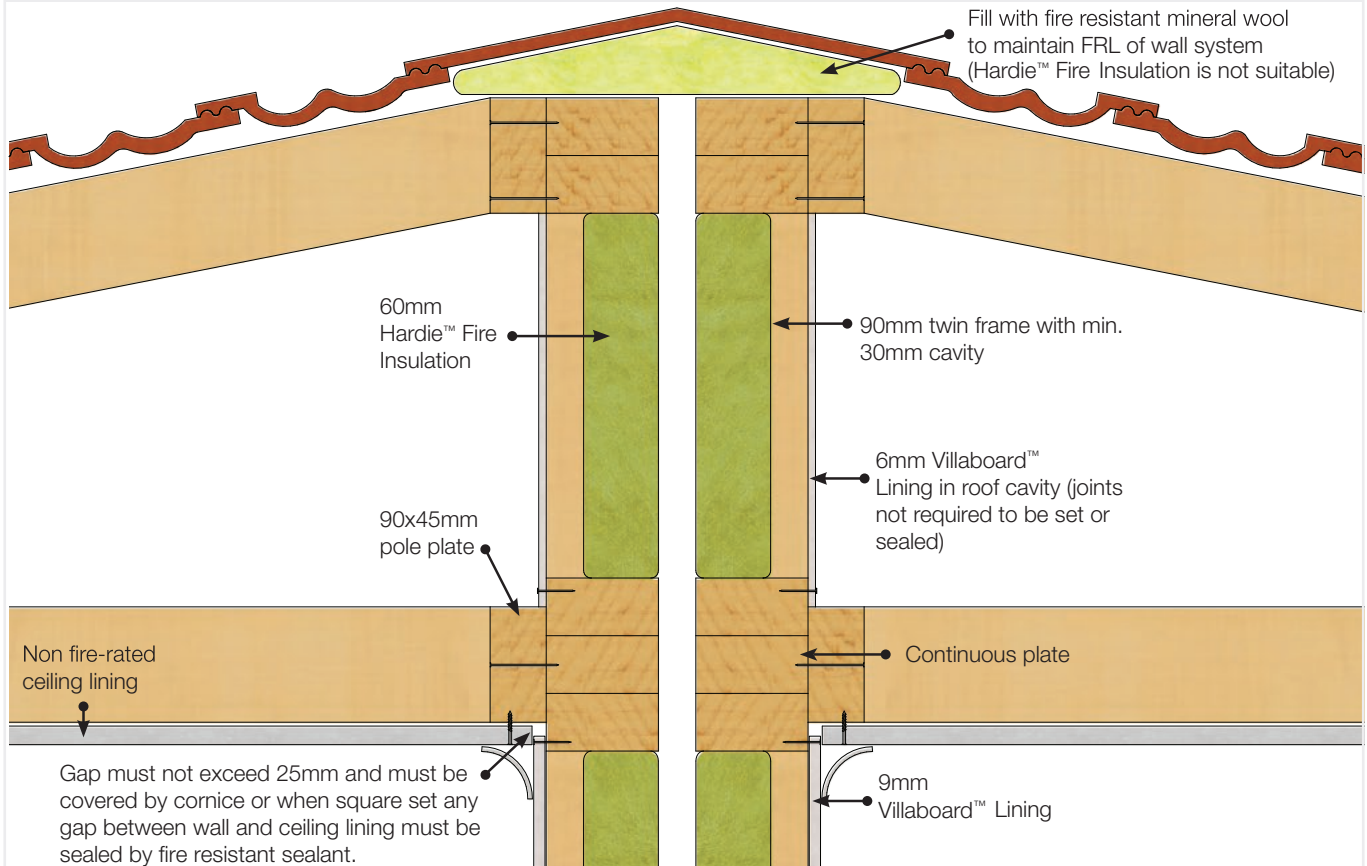

FIGURE 14 HARDIE™ SMART INTERTENANCY WALL SYSTEM WITH FRAMED ROOF

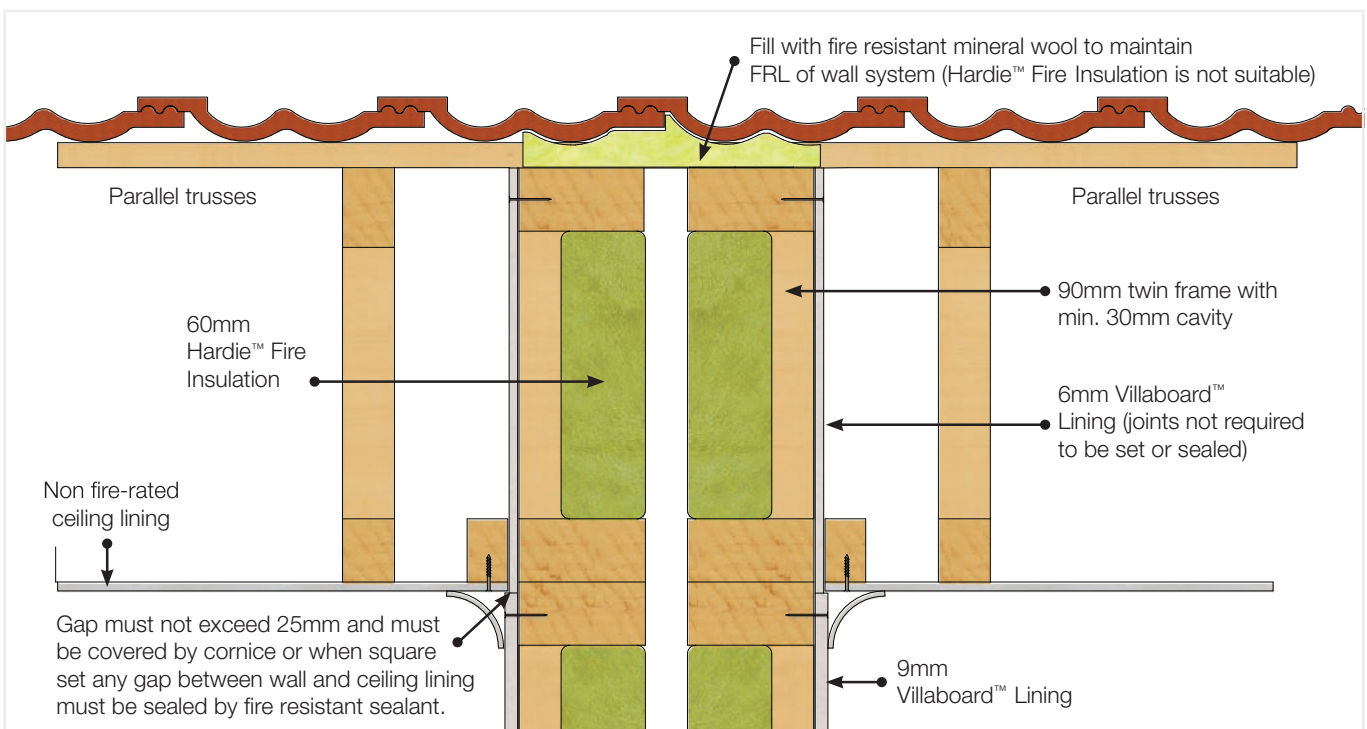

FIGURE 15 HARDIE™ SMART INTERTENANCY WALL SYSTEM WITH PARALLEL ROOF TRUSSES

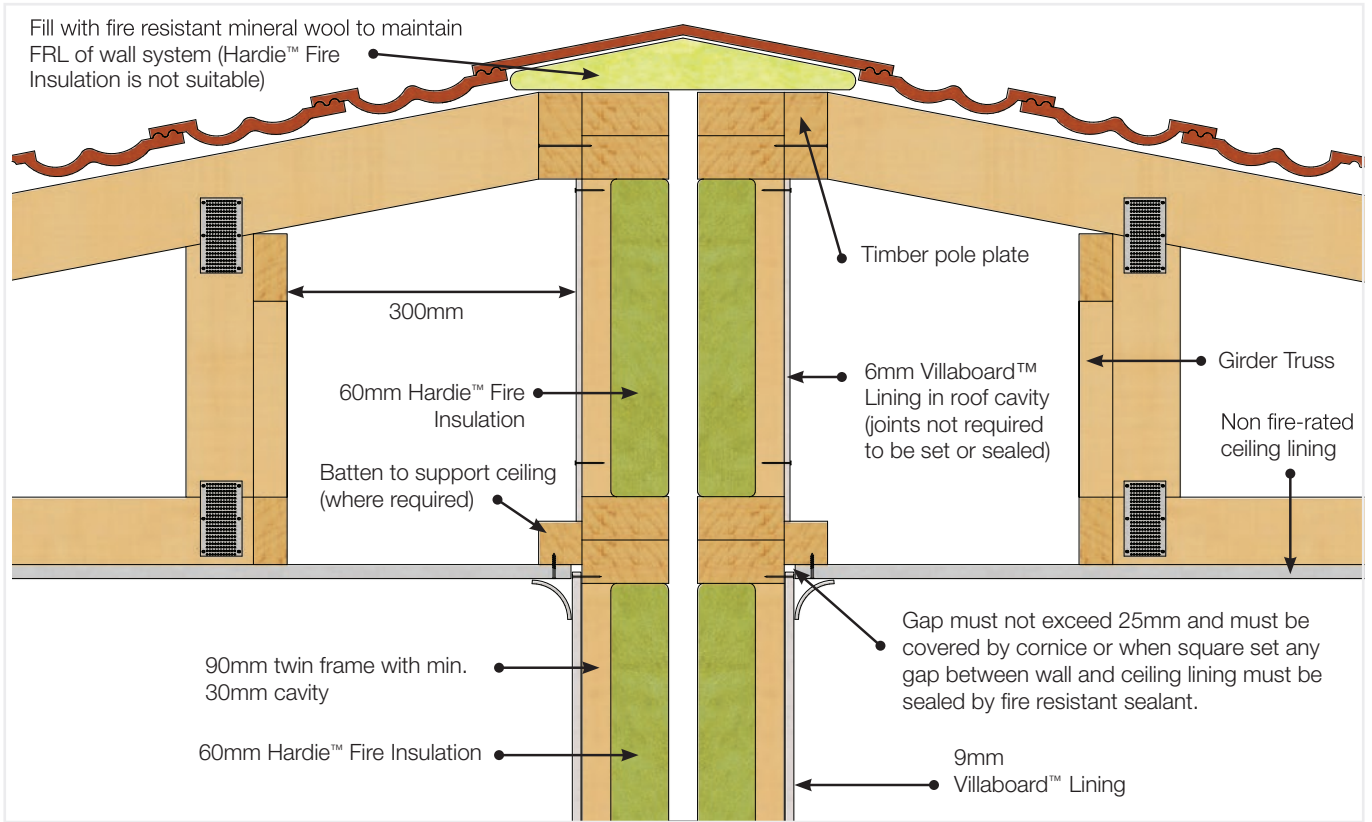

FIGURE 16 HARDIE™ SMART INTERTENANCY WALL SYSTEM WITH PARALLEL GIRDER TRUSS WITH ACCESS

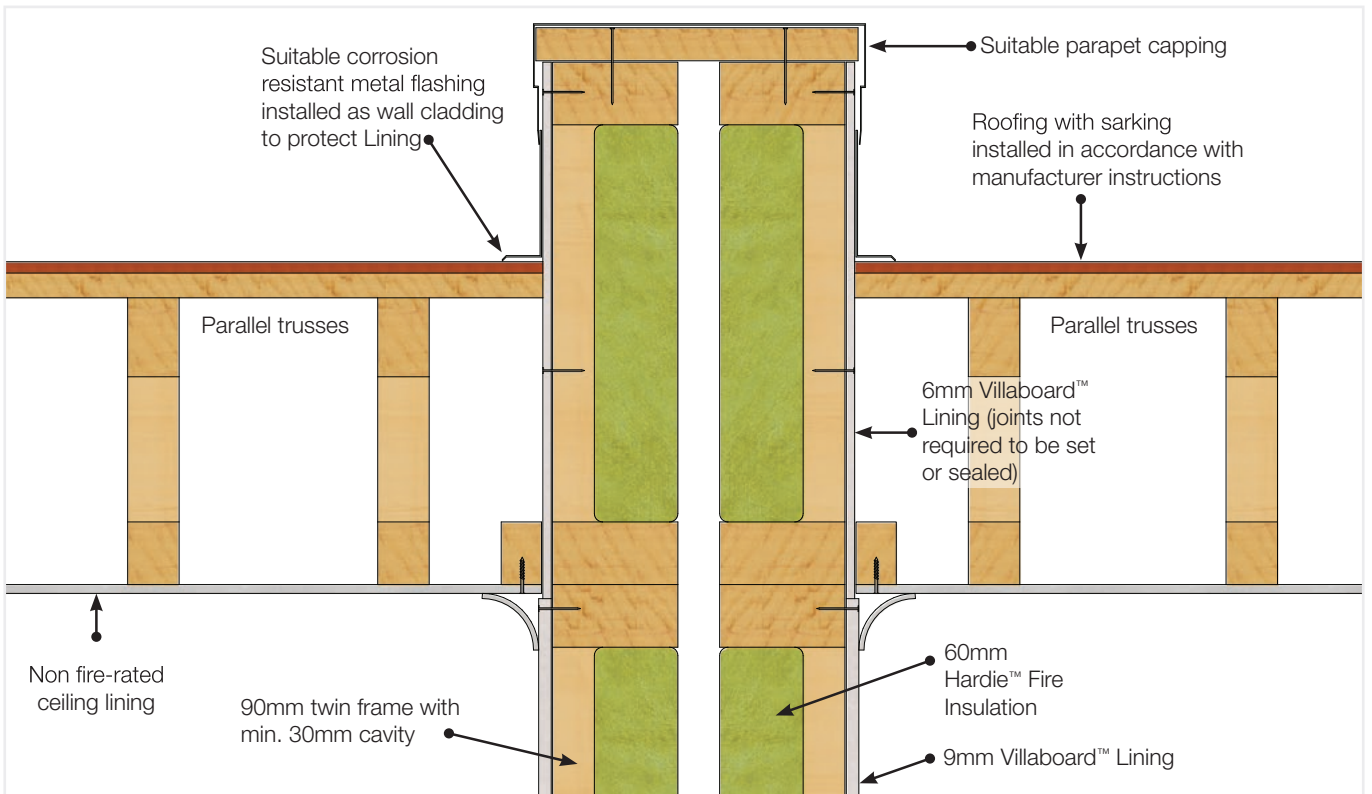

FIGURE 17 HARDIE™ SMART INTERTENANCY WALL SYSTEM WITH PARAPET ROOF JUNCTION

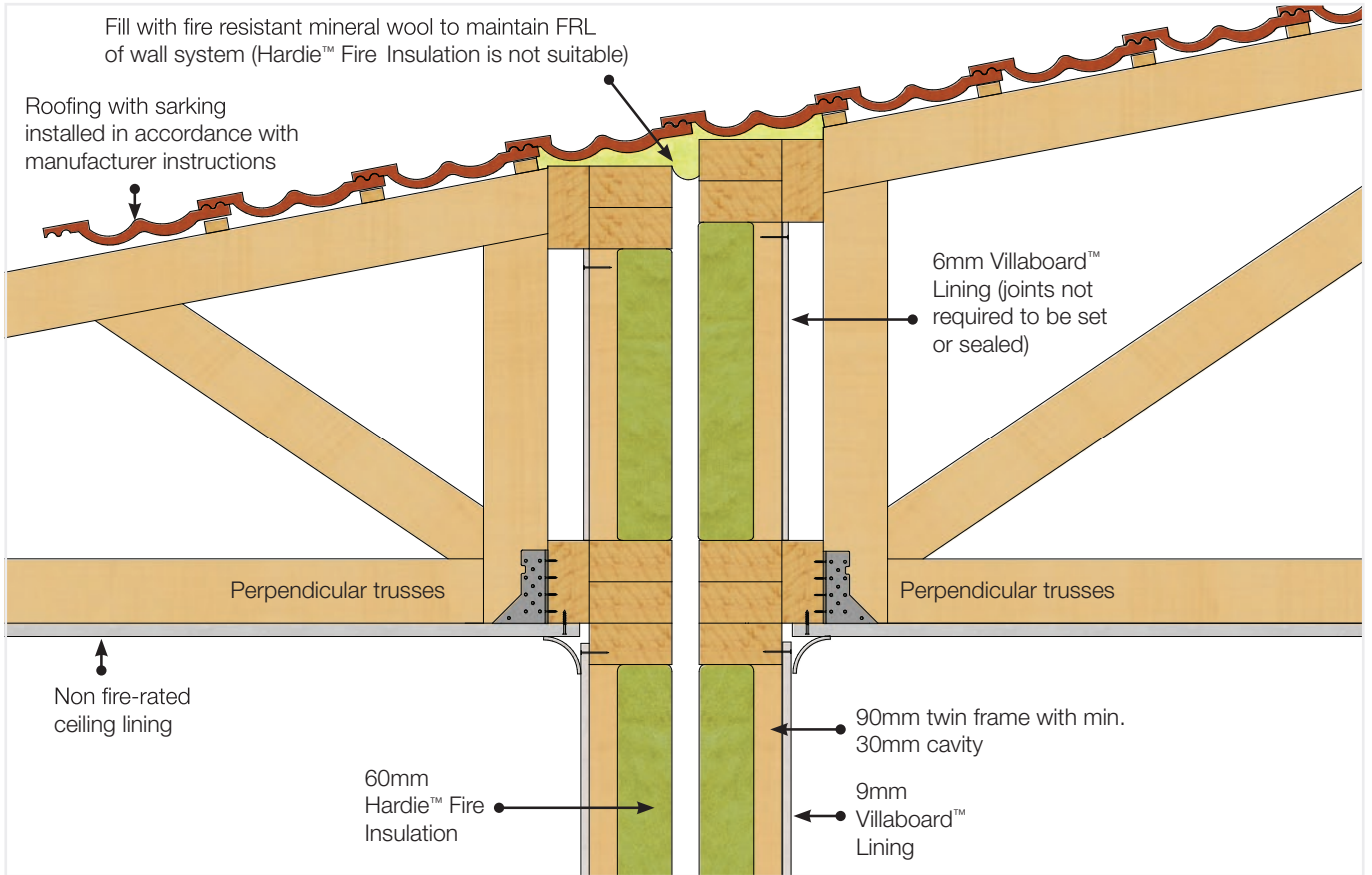

FIGURE 18 HARDIE™ SMART INTERTENCY WALL SYSTEM WITH PERPENDICULAR ROOF TRUSSES

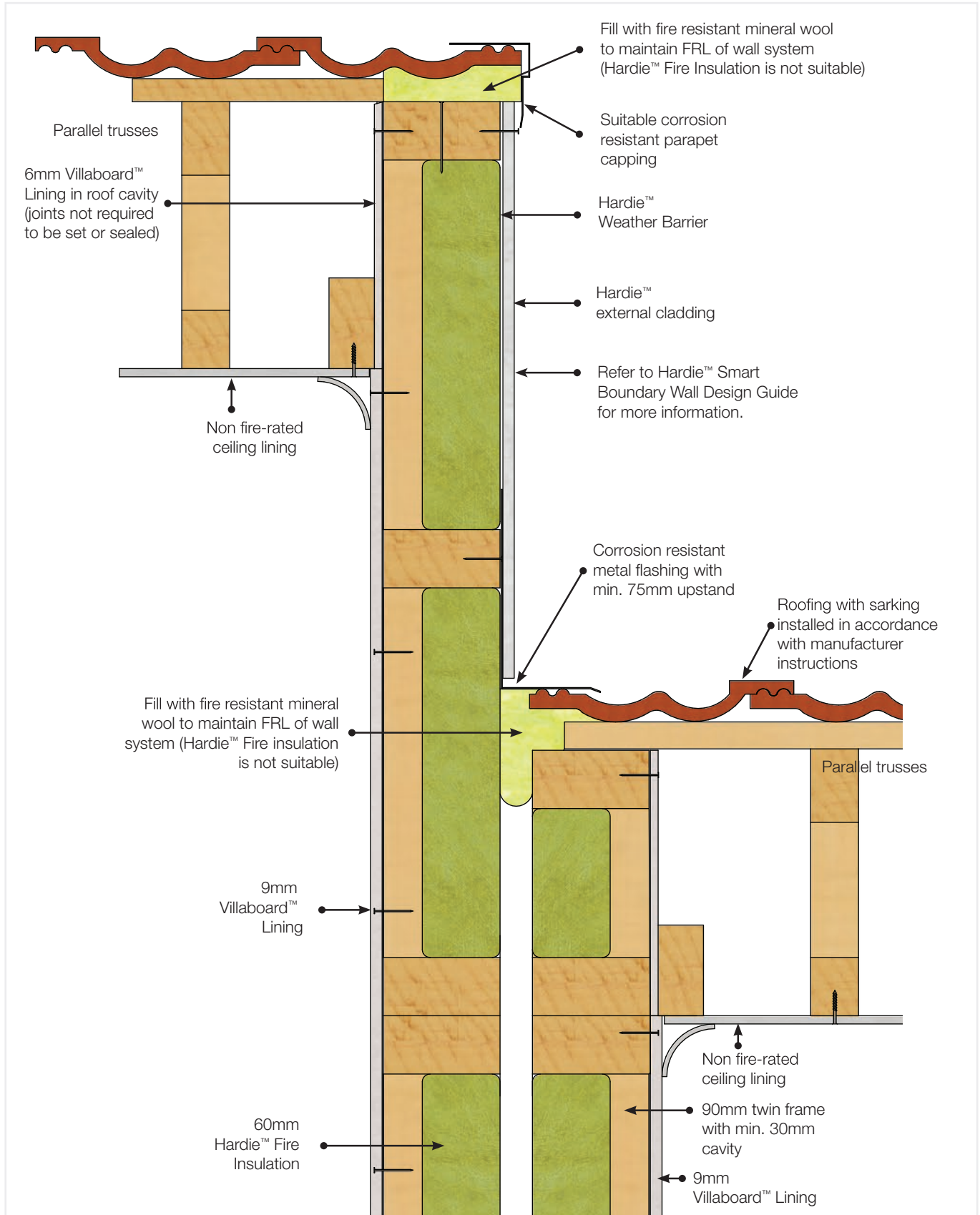

FIGURE 19 HARDIE™ SMART INTERTENANCY WALL SYSTEM TO HARDIE™ SMART BOUNDARY WALL SYSTEM ABOVE

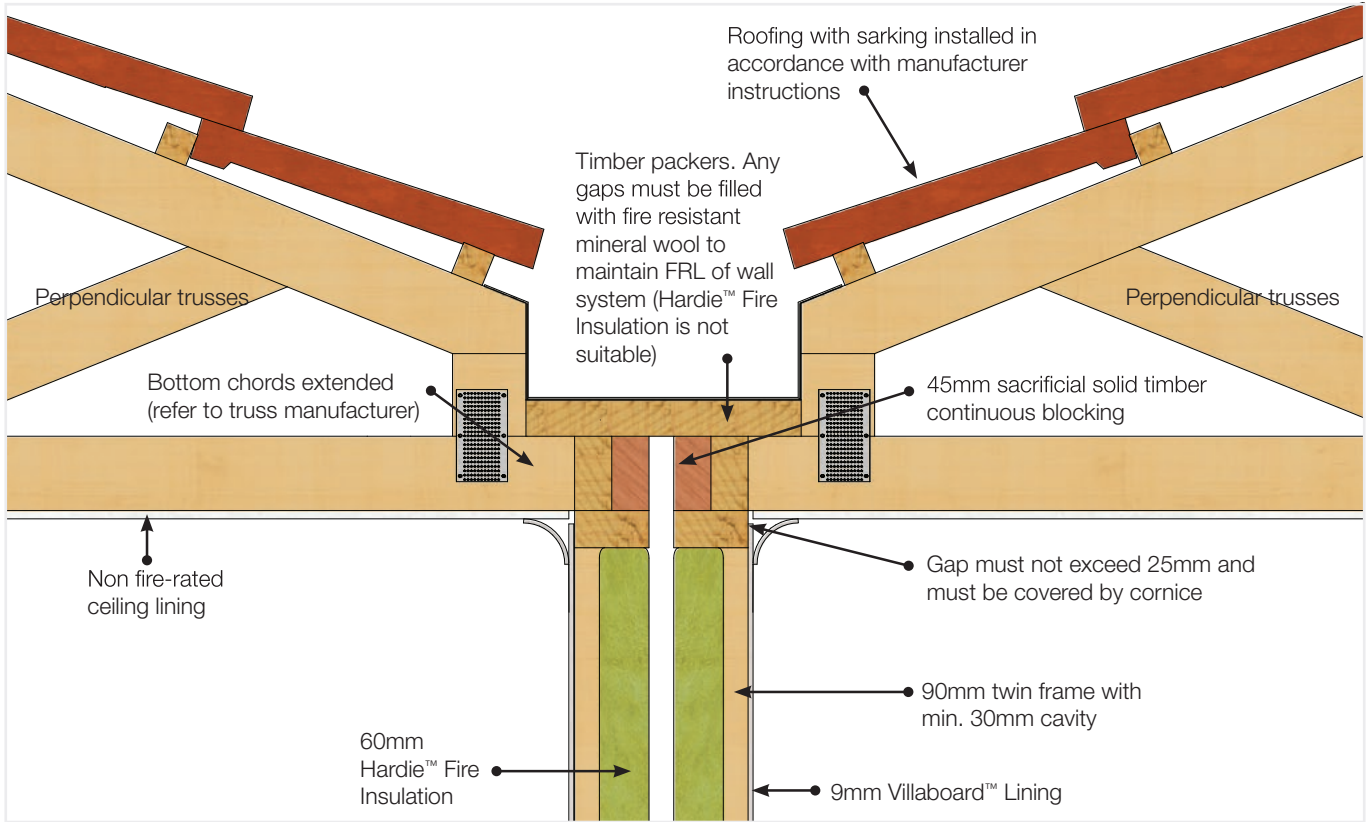

FIGURE 20 HARDIE™ SMART INTERTENANCY WALL SYSTEM TO GUTTER BOX WITH PERPENDICULAR ROOF TRUSSES

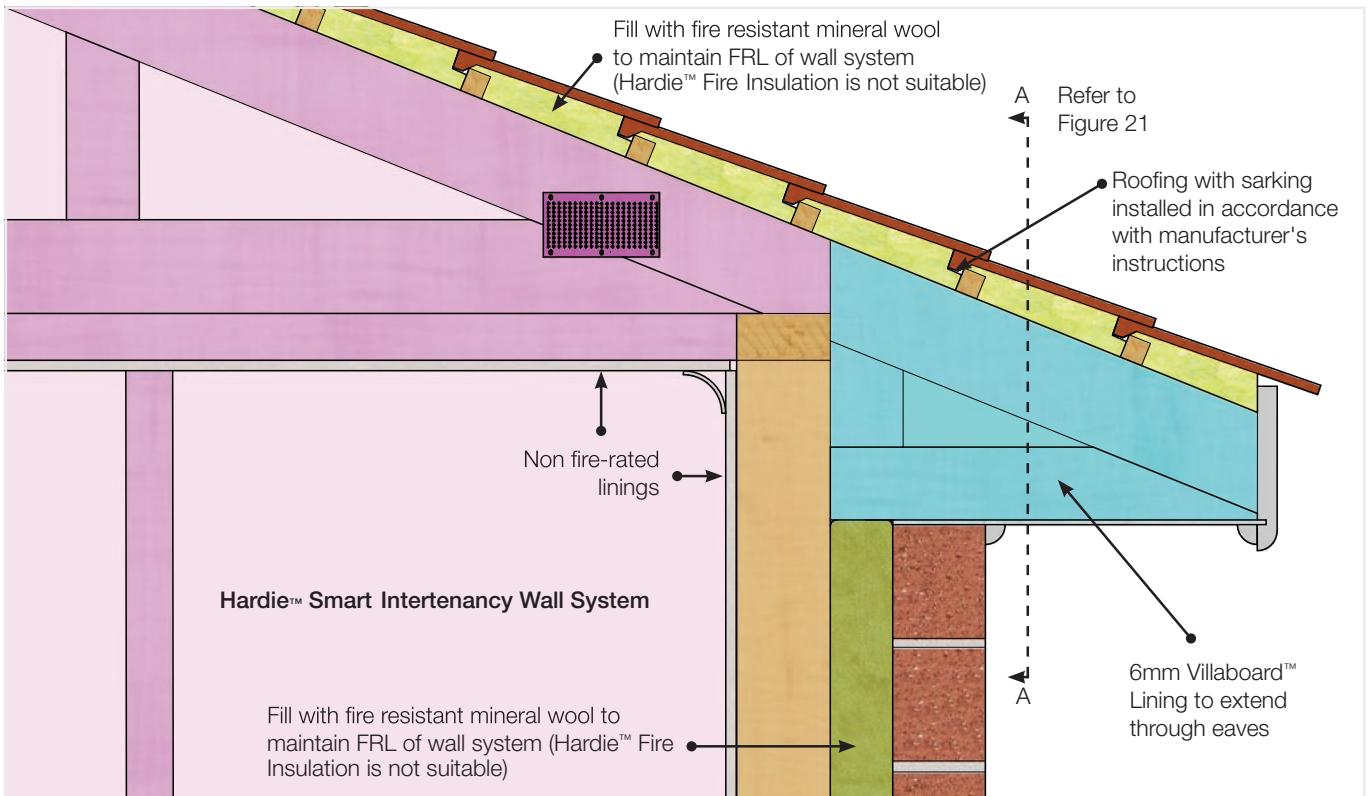

FIGURE 21 EAVES SEPARATION LONGITUDINAL SECTION ALONG FIRE WALL

NOTE: NON-COMBUSTIBLE EAVES SEPARATION IN ACCORDANCE WITH NCC VOL 2. FIGURE 3.7.3.2 - DIAGRAM B

THE VILLABOARD™ LINING MAY BE INSTALLED TO ONLY ONE SIDE OF THE RAFTER, TRUSS OR SUPPORTING FRAMEWORK, PROVIDED IT FORMS A CONTINUOUS BARRIER WITH THE HARDIE™ SMART INTERTENANCY WALL.

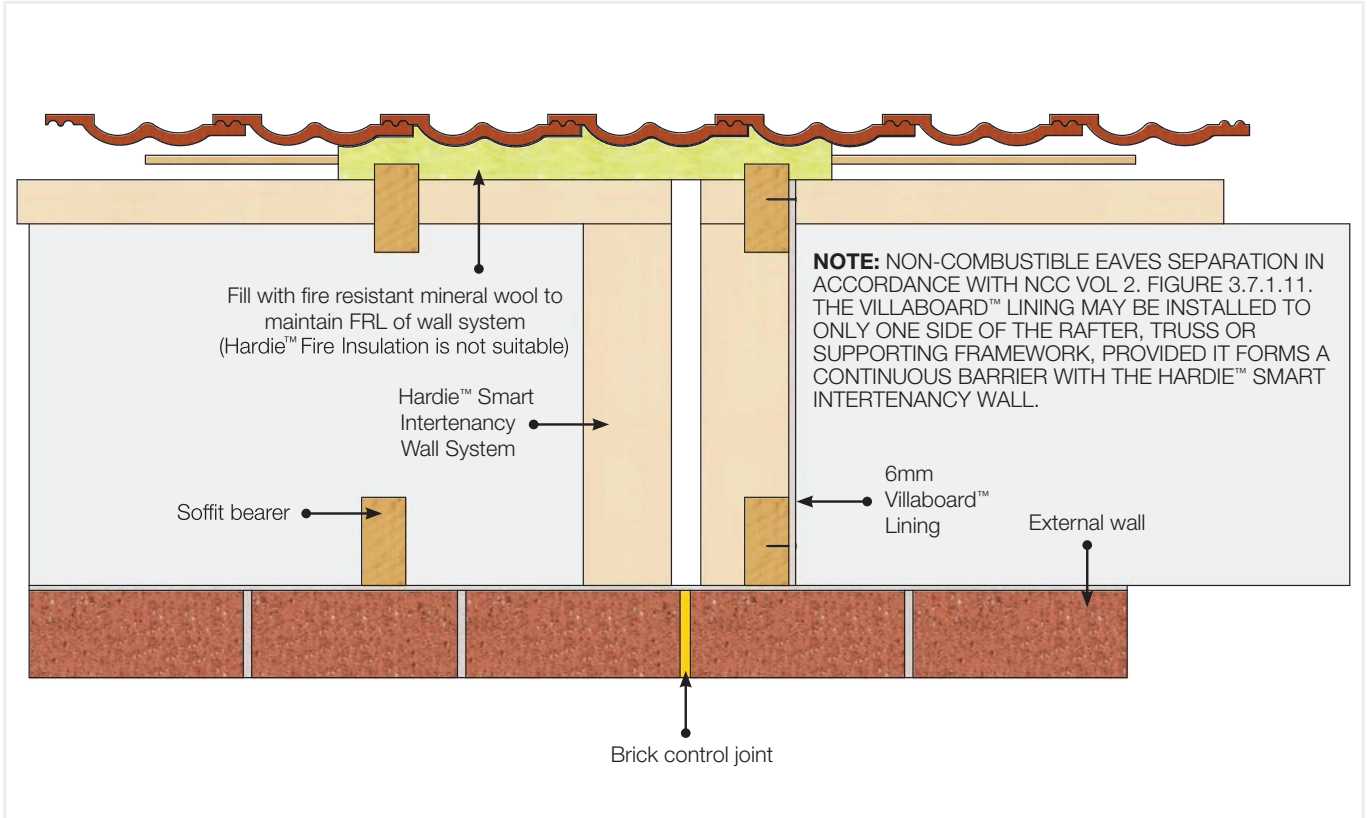

FIGURE 22 CROSS SECTION OF EAVES SEPARATION AT LINE A

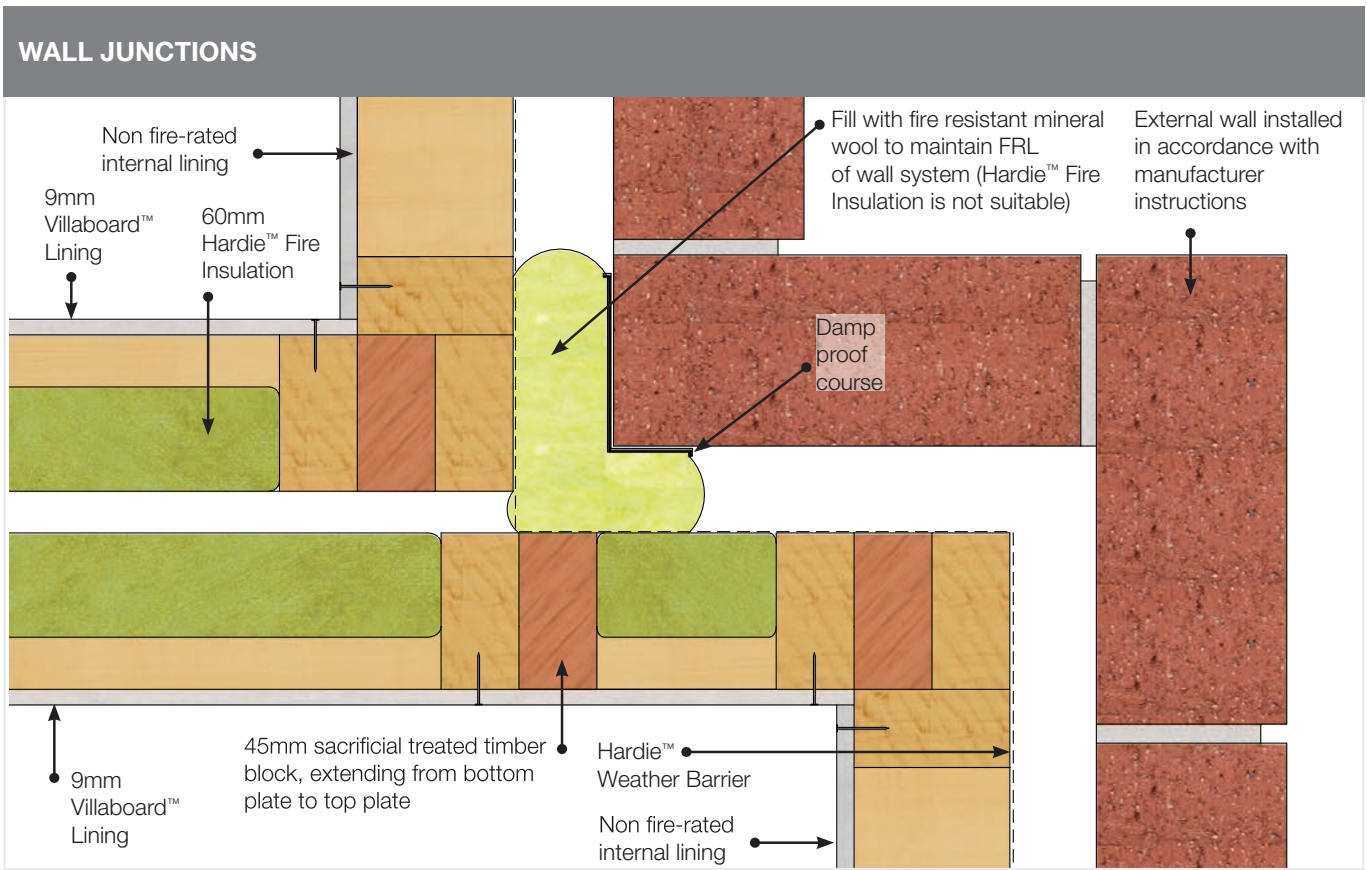

FIGURE 23 HARDIE™ SMART INTERTENCY WALL SYSTEM TO EXTERNAL BRICK RETURN

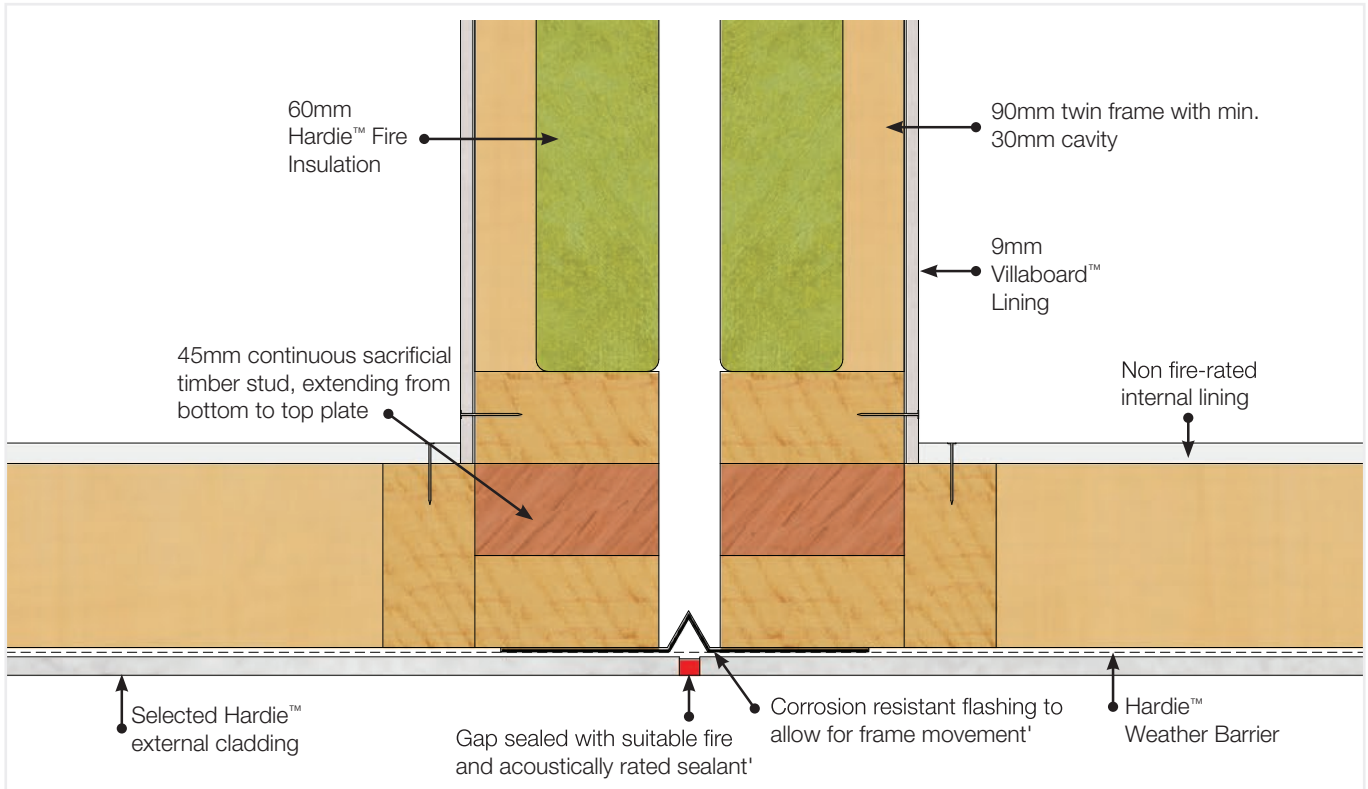

FIGURE 24 HARDIE™ SMART INTERTENANCY WALL SYSTEM TO NON-FIRE-RATED EXTERNAL CLADDING WALL

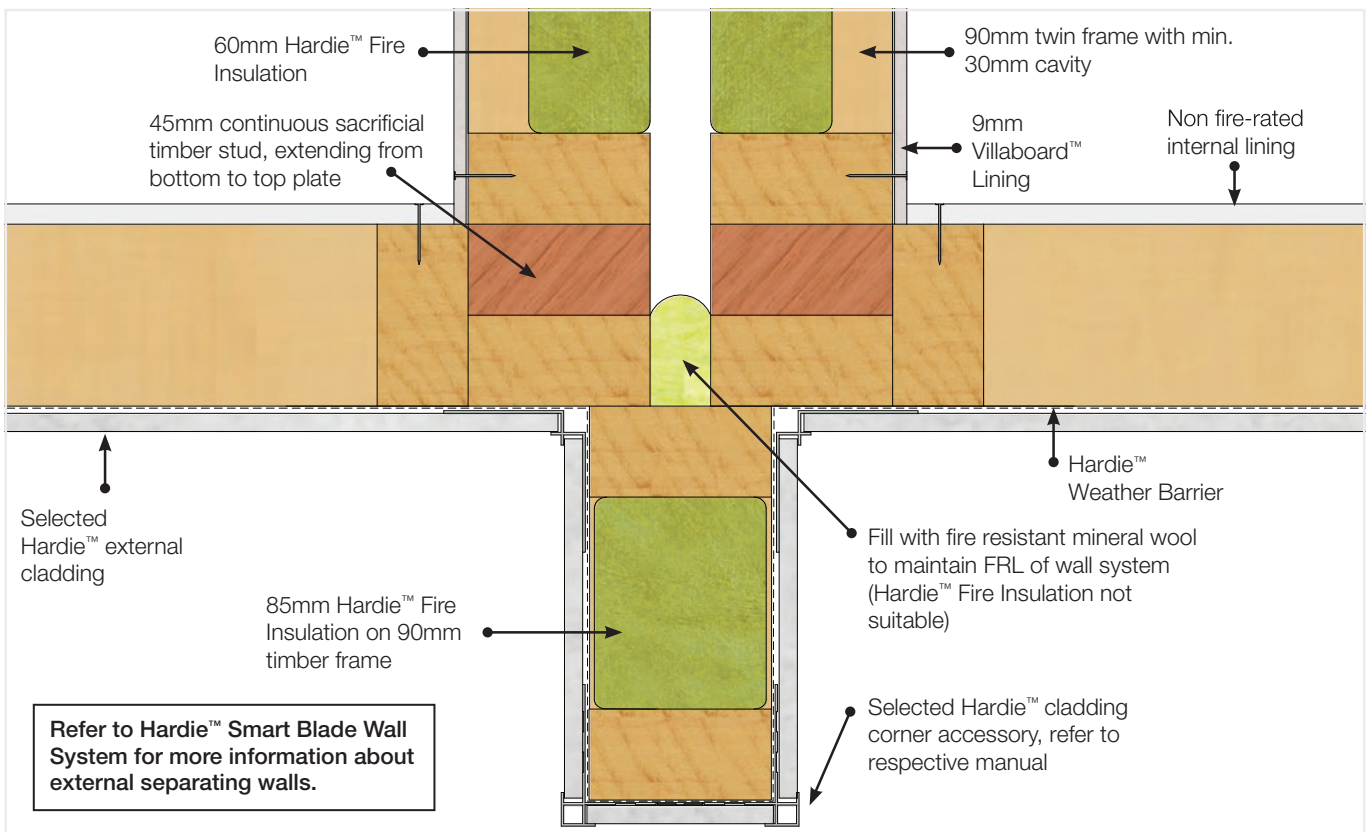

FIGURE 25 HARDIE™ SMART INTERTENANCY WALL SYSTEM EXTERNAL PROJECTION TO LIGHTWEIGHT FAÇADE

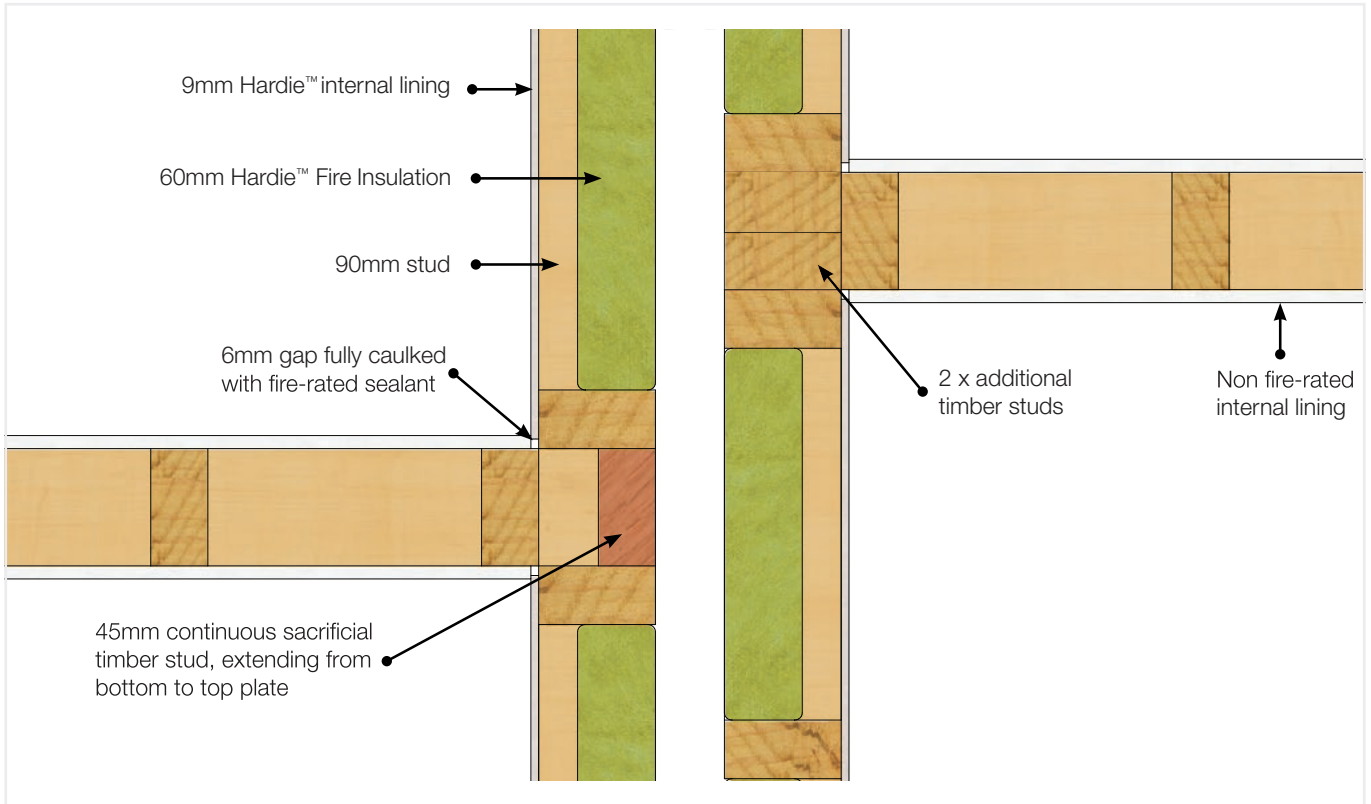

FIGURE 26 HARDIE™ SMART INTERTENANCY WALL SYSTEM TO NON FIRE-RATED INTERNAL PARTITION WALL

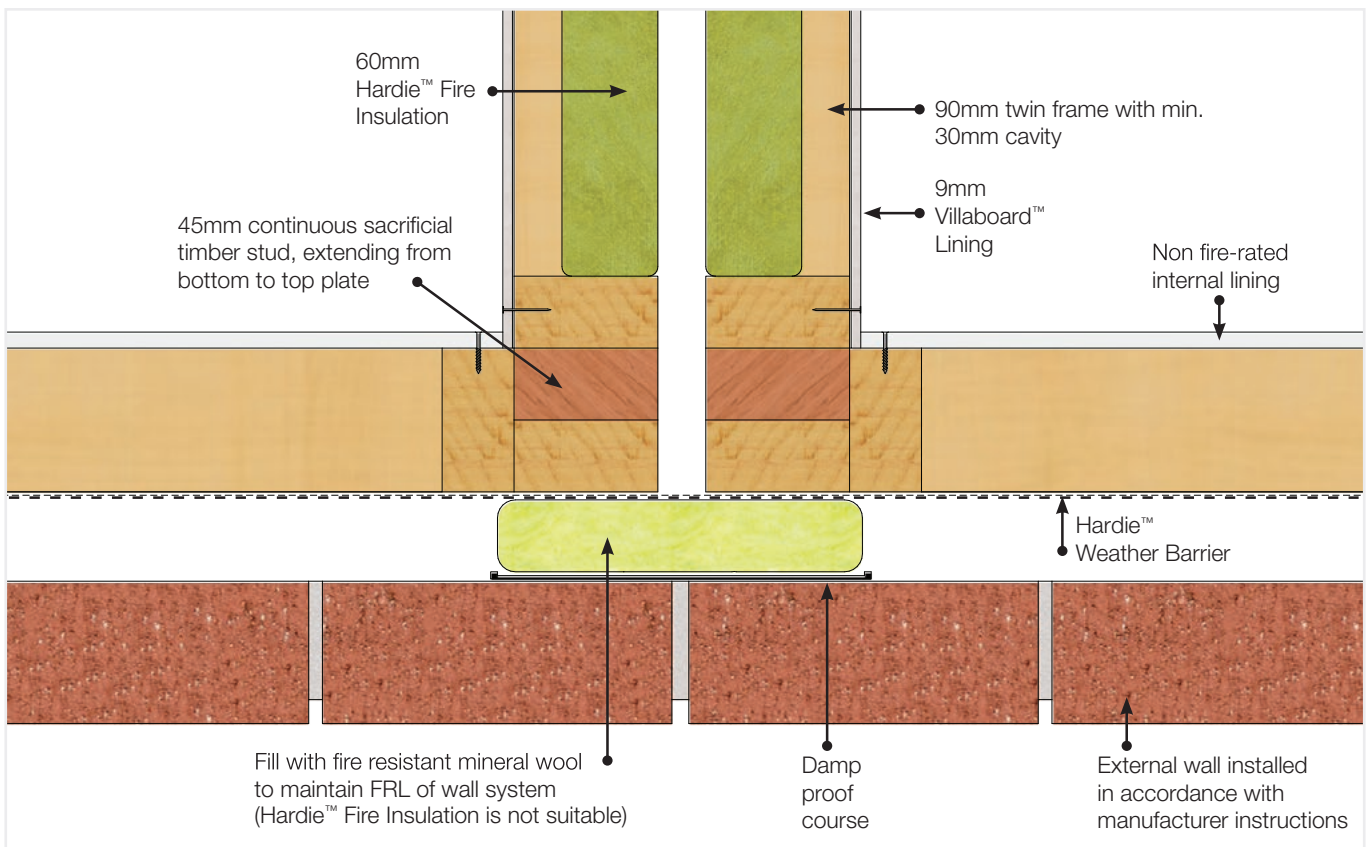

FIGURE 27 HARDIE™ SMART INTERTENANCY WALL SYSTEM TO NON FIRE-RATED EXTERNAL CLADDING WALL

CONTROL JOINTS

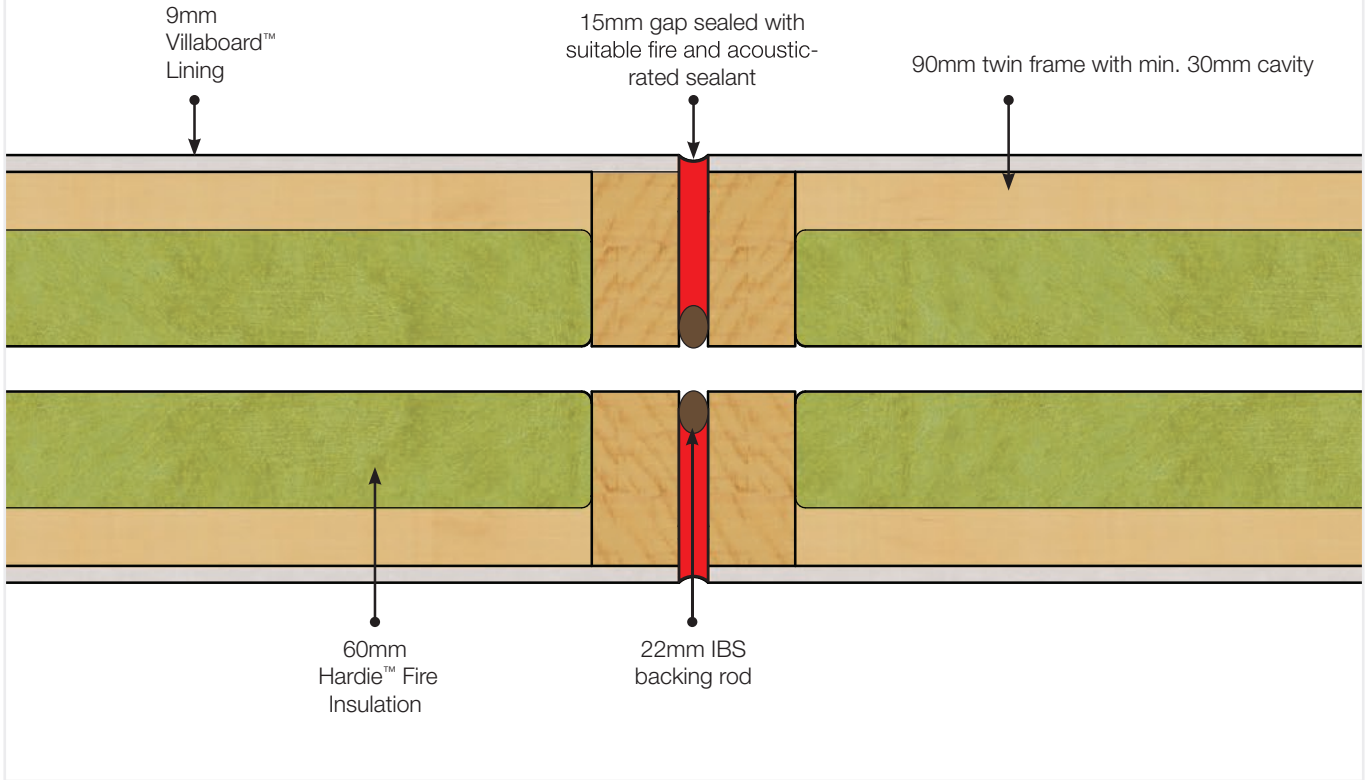

FIGURE 28 HARDIE™ SMART INTERTENCY WALL CONTROL JOINT

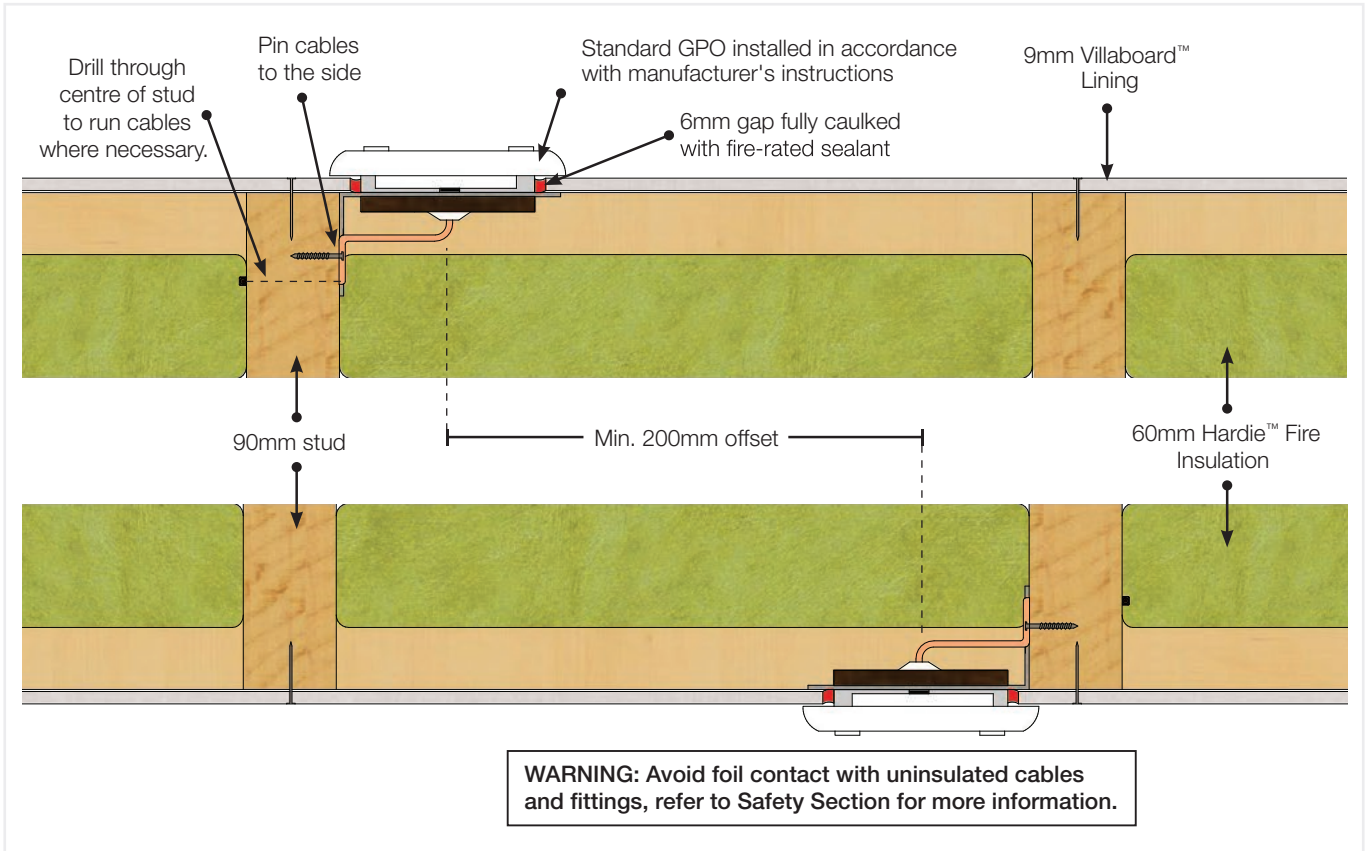

FIGURE 29 ELECTRICAL SERVICES (GPO/POWER POINTS) - SECTION FROM ABOVE

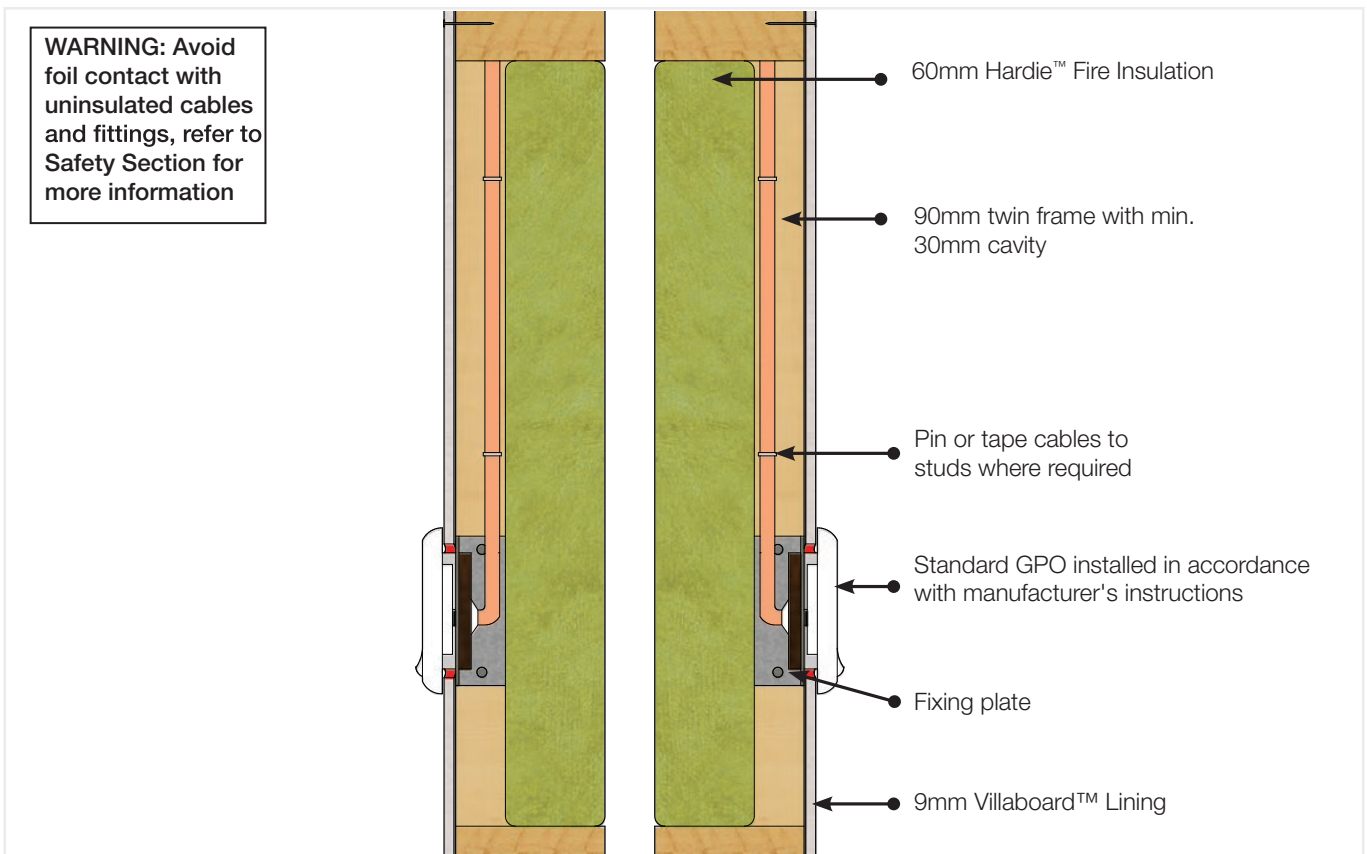

FIGURE 30 ELECTRICAL SERVICES (GPO/POWER POINTS) - SECTION FROM SIDE

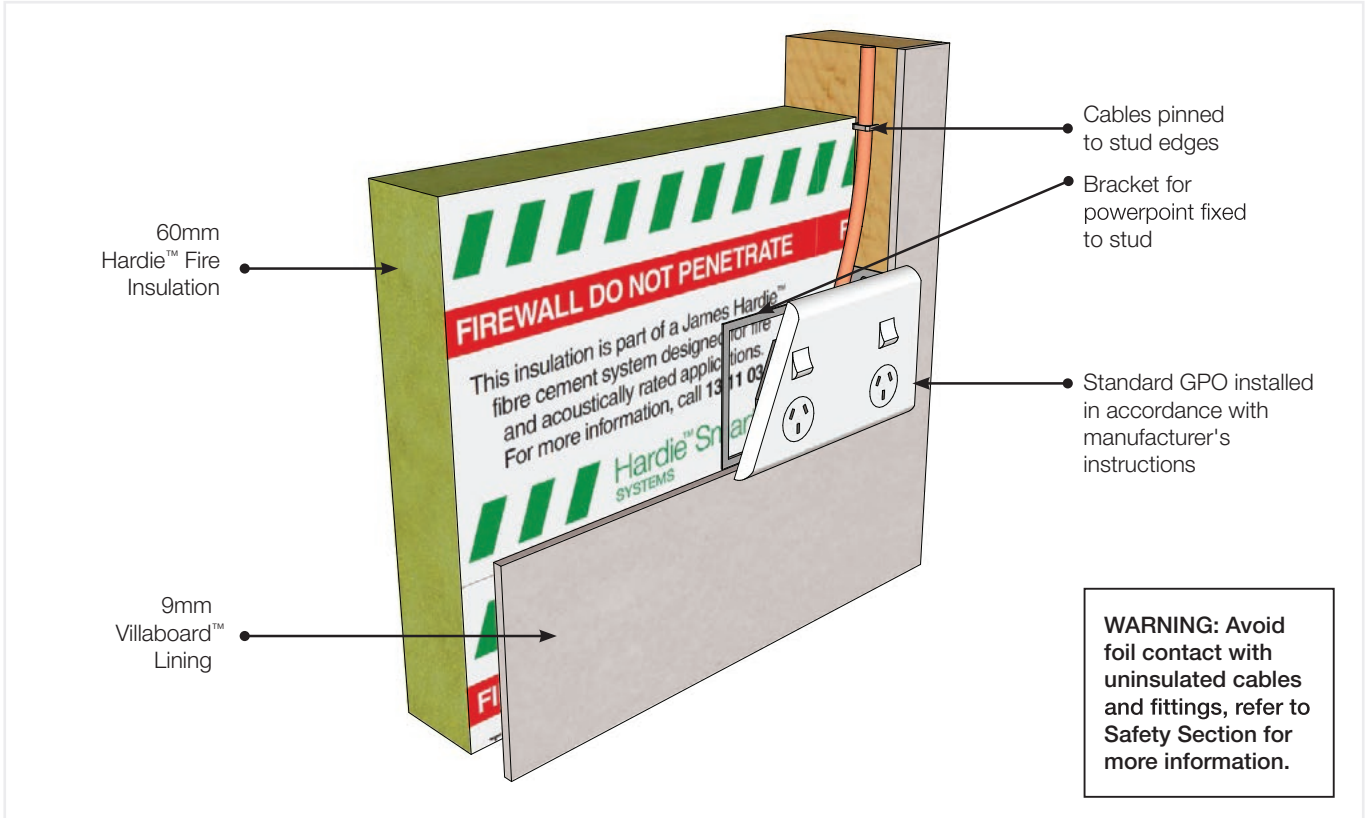

FIGURE 31 ELECTRICAL SERVICES (GPO/POWER POINTS) PERSPECTIVE

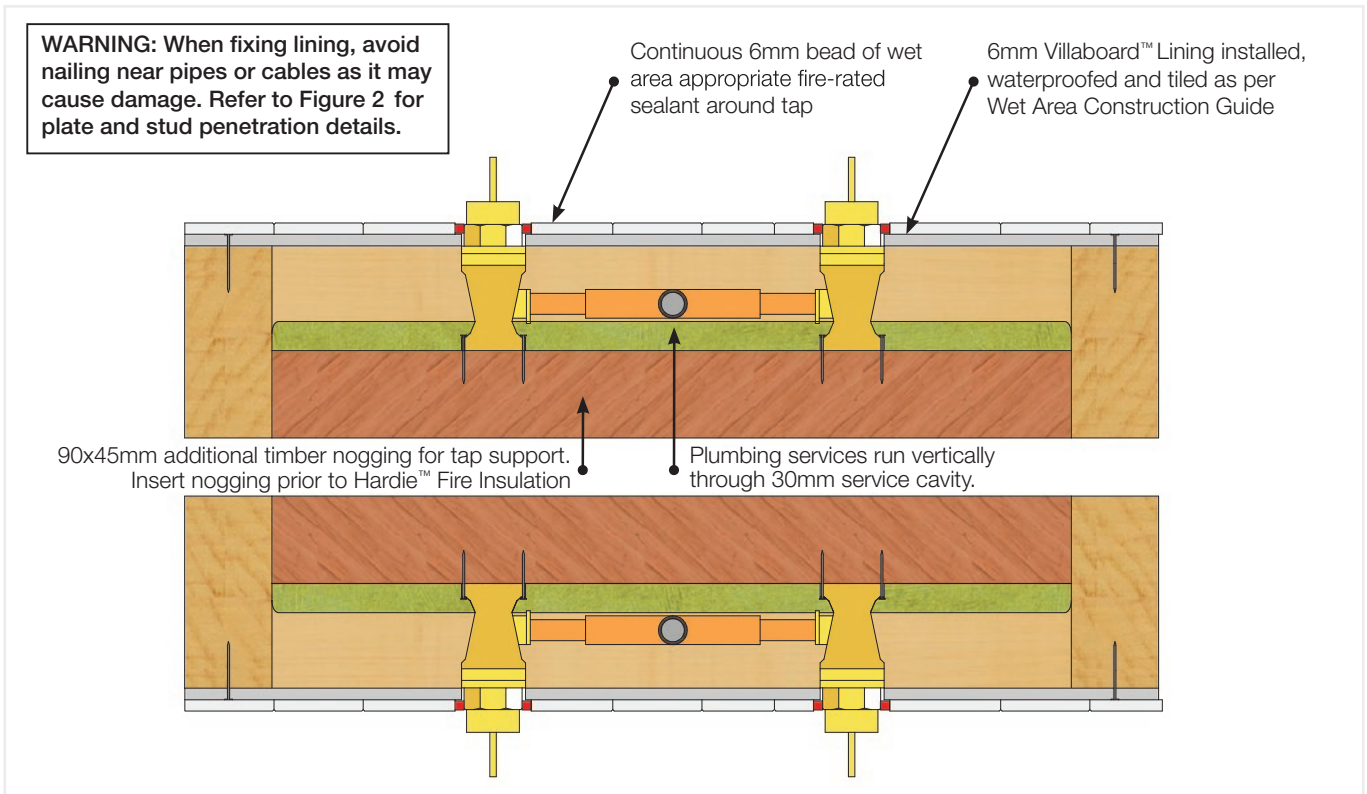

FIGURE 32 HOT/COLD PLUMBING TAPS - SECTION FROM ABOVE

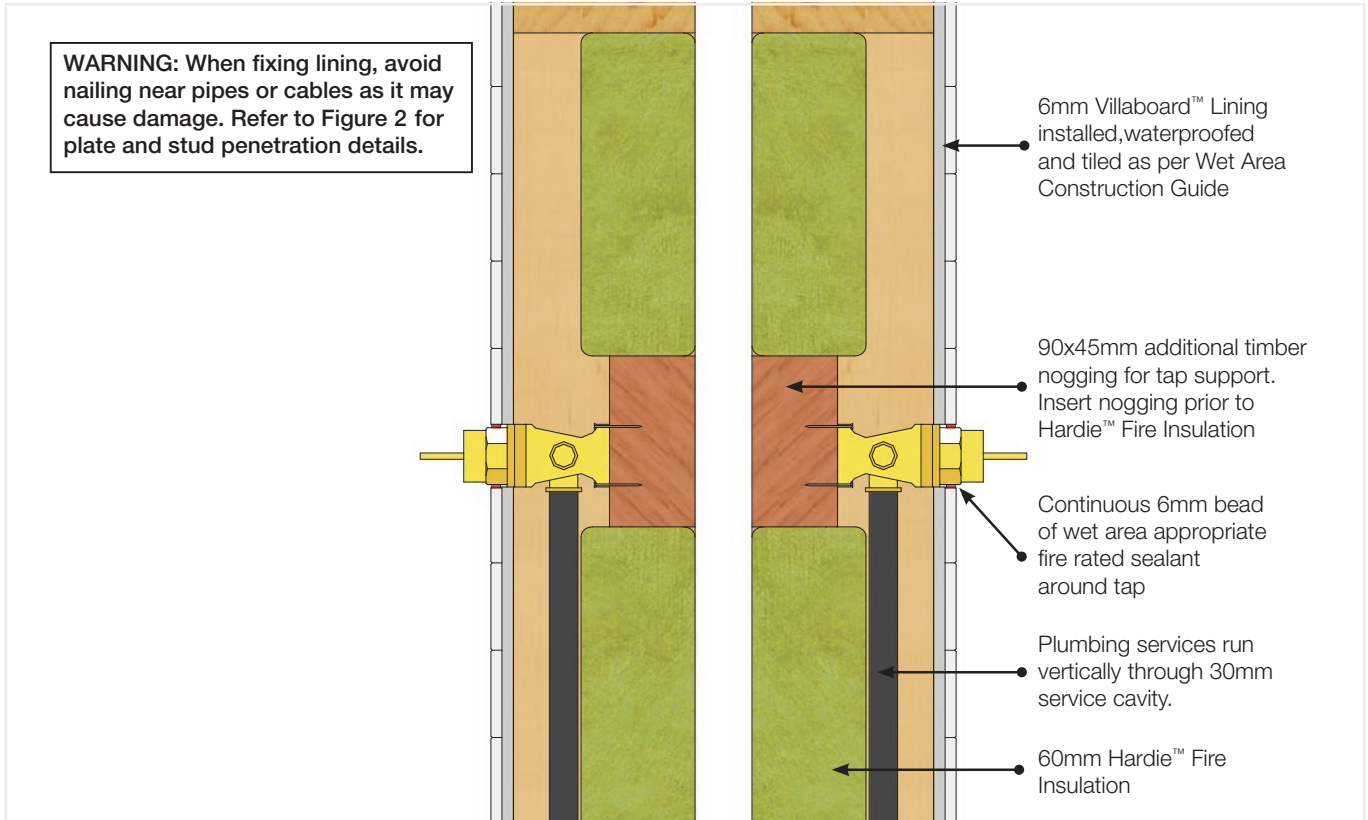

FIGURE 33 HOT/COLD PLUMBING TAPS - SECTION FROM SIDE

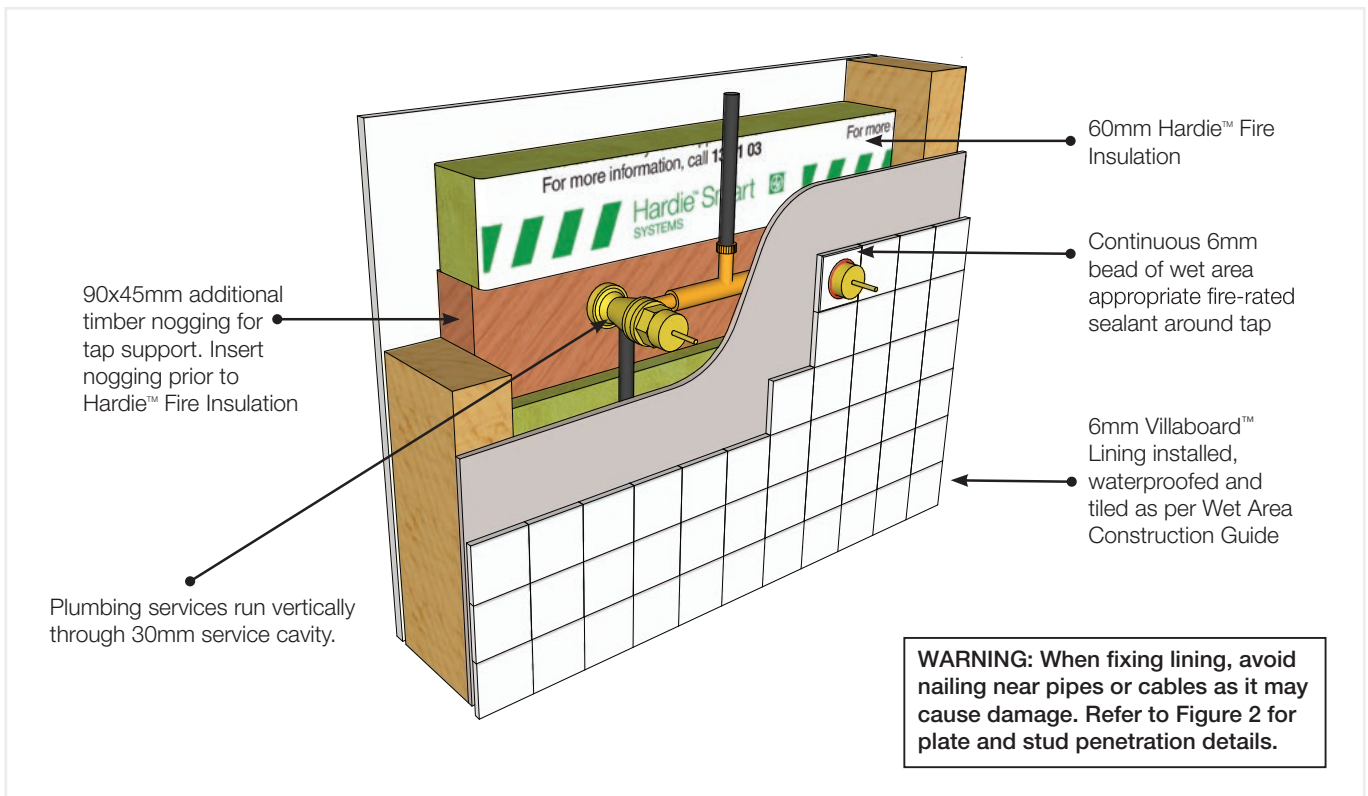

FIGURE 34 HOT/COLD PLUMBING TAPS - PERSPECTIVE

ONLINE TOOLS

Estimation tools, CAD details, and site specific documents are available via our specification website myhardies.jameshardie.com.au
For more information visit the website or Contact James Hardie™ on 13 11 03.

WARRANTY

Hardie™ Smart Wall System components supplied by James Hardie are backed by a Warranty.
The Warranty period will vary based on the specific system component.
For Warranty Terms & Conditions refer to www.jameshardie.com.au or Contact James Hardie™ on 13 11 03.

CODEMARK CERTIFICATION



SITE INSTALLATION CHECKLIST

BACKGROUND

Date: _____ Installer: _____

Project Address: _____

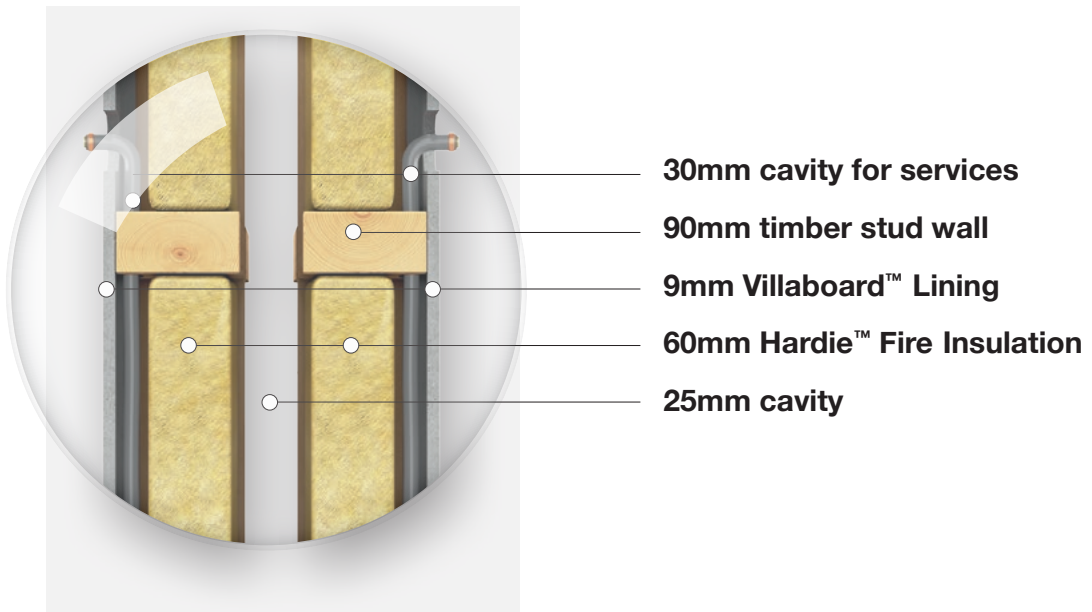

- 30mm cavity for services
- 90mm timber stud wall
- 9mm Villaboard™ Lining
- 60mm Hardie™ Fire Insulation
- 25mm cavity

SCOPE

The purpose of this check list is to help deliver a quick, low fuss successful installation of Hardie™ Smart Intertenancy wall system and assist in identifying areas of non-compliance with the design guide current at the time of installation.

This form has been categorised in three inspections to ensure compliance:

1. Framing Stage
2. Insulation Stage
3. Lining Stage





All references made in this document refer to the latest Hardie™ Smart Intertenancy wall system Design Guide available at www.jameshardie.com.au.

INSPECTIONS	CARRIED BY	DATE	SIGNATURE
FRAMING*			
INSULATION*			
LINING			

*Optional Inspections



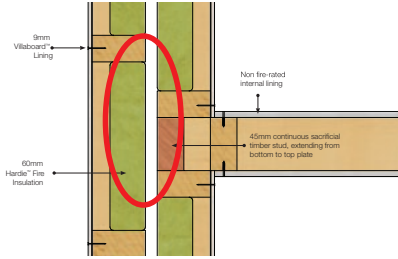

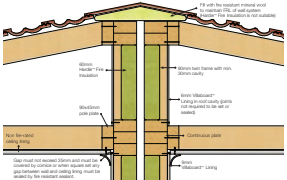
FRAMING INSPECTION (OPTIONAL)

Date: _____ Completed by: _____ Signature: _____

ITEM	SUB-ITEM	REQUIREMENT	YES	NO	COMMENTS
FRAMING CHARACTERISTICS	Depth (mm)	90	<input type="checkbox"/>	<input type="checkbox"/>	
	Width (mm)	45 or 35	<input type="checkbox"/>	<input type="checkbox"/>	
	Stud Spacing (mm)	Not to exceed 600mm			
	Noggings	Not to exceed 1200mm			
	Material	Minimum MGP10 grade pine or suitable LVL equivalent			
FLOOR JUNCTIONS	Additional Timber Batten	Discontinuous wall method (perpendicular joists): sacrificial solid 45mm timber beam runs continuously along wall and then a solid block is used in between joists. FIGURE 7 	<input type="checkbox"/>	<input type="checkbox"/>	
		Discontinuous wall method (parallel joists): double solid 45mm timber beam along wall. FIGURE 6 			
		For all other roof junctions refer to relevant details in Design Guide.			
WALL JUNCTIONS	Additional Timber Stud	Continuous 45mm solid timber stud at wall junction. 			
ROOF JUNCTIONS	Wall continuity at the roof junction	Ensure wall system continues at the roof junction with lining and Hardie™ Fire Insulation. See options: Figures 13-21  	<input type="checkbox"/>	<input type="checkbox"/>	
		Example of Villaboard™ Lining, cladding over Hardie™ Fire extending to underside of roof lining.			

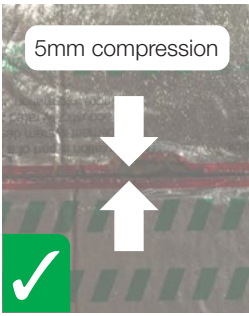
INSULATION INSPECTION (OPTIONAL)

Date: _____ Completed by: _____ Signature: _____

ITEM	SUB-ITEM	REQUIREMENT	YES	NO	COMMENTS
CHARACTERISTICS	Brand	Hardie™ Fire Insulation	<input type="checkbox"/>	<input type="checkbox"/>	
	Depth	60mm	<input type="checkbox"/>	<input type="checkbox"/>	
COMPRESSION Ensure 5mm compression throughout, no gaps.	Insulation Joints	 	<input type="checkbox"/>	<input type="checkbox"/>	
	Edges with frame		<input type="checkbox"/>	<input type="checkbox"/>	
	Gaps	Fill any gaps with compressed Hardie™ Fire Insulation ensuring tight fit 	<input type="checkbox"/>	<input type="checkbox"/>	

LINING INSPECTION

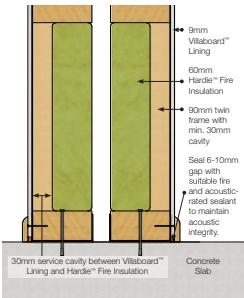
ITEM	SUB-ITEM	REQUIREMENT	YES	NO	COMMENTS
CHARACTERISTICS	Lining	Villaboard™ Lining 9mm	<input type="checkbox"/>	<input type="checkbox"/>	
BASE JUNCTION	Concrete Slab Junction	If gap exceeds 10mm at the base junction (see circled area below) use backing rod to support fire and acoustic sealant 	<input type="checkbox"/>	<input type="checkbox"/>	To maintain acoustic properties, fire and acoustic sealant required along the perimeter of wall and the slab junction.

SITE INSTALLATION CHECKLIST

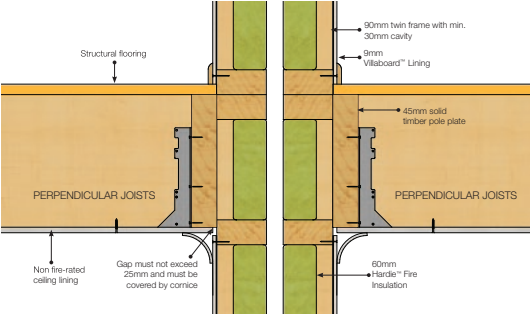
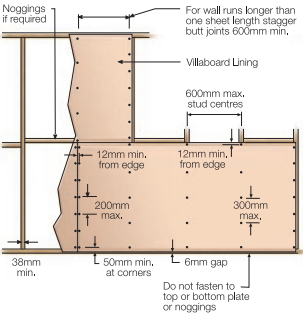
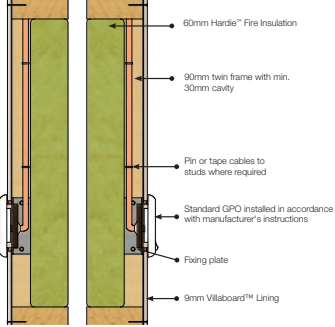
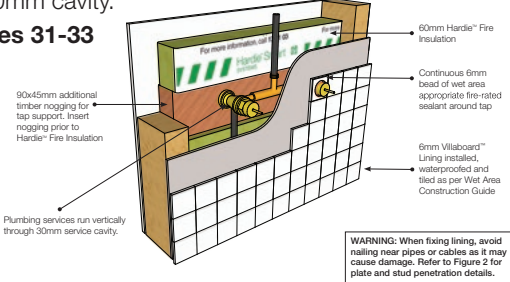
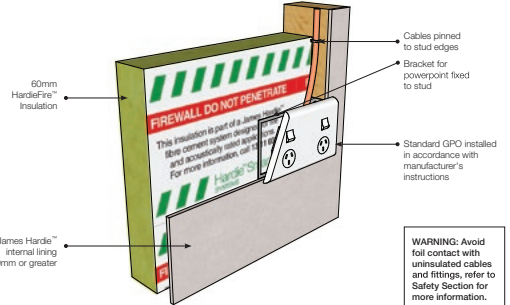
<p>CEILING JUNCTION</p>	<p>Cornice and Lining Junction</p>	<p>Gap at the ceiling junction not to exceed 25mm</p> 	<p><input type="checkbox"/></p>	<p><input type="checkbox"/></p>	<p>If cornice is not used, gap must be caulked with fire and acoustically rated sealant and must not exceed 6mm.</p>
<p>LINING</p>	<p>Fastening</p>		<p><input type="checkbox"/></p>	<p><input type="checkbox"/></p>	<p>If using tiles, fastening centres are reduced to 200mm everywhere and tile weight may reduce stud centres. Refer to Villaboard™ lining manual.</p>
<p>PENETRATIONS</p>	<p>General Power Outlets and other boxes</p>	<p>Figures 28-30</p> <p>WARNING: Avoid foil contact with uninsulated cables and fittings, refer to Safety Section for more information</p> 	<p><input type="checkbox"/></p>	<p><input type="checkbox"/></p>	<p>Standard GPO may be used.</p>
<p>PENETRATIONS</p>	<p>Plumbing and others</p>	<p>Plumbing run within the 30mm cavity.</p> <p>Figures 31-33</p>  <p>WARNING: When fixing lining, avoid nailing near pipes or cables as it may cause damage. Refer to Figure 2 for plate and stud penetration details.</p>	<p><input type="checkbox"/></p>	<p><input type="checkbox"/></p>	<p>To maintain acoustic properties, wet area fire and acoustic sealant required around tap and other penetrations through the Villaboard™.</p>
<p>PENETRATIONS</p>	<p>Cables and Power box</p>	<p>Cables are pinned to the stud edges</p>  <p>WARNING: Avoid foil contact with uninsulated cables and fittings, refer to Safety Section for more information.</p>	<p><input type="checkbox"/></p>	<p><input type="checkbox"/></p>	<p>Standard GPO may be used.</p> <p>Do not penetrate Hardie™ Fire.</p>



**For information and advice
call 13 11 03 | [jameshardie.com.au](https://www.jameshardie.com.au)**

Australia November 2023



© 2023 James Hardie Australia Pty Ltd ABN 12 084 635 558
™ and ® denote a trademark or registered mark owned by James Hardie Technology Limited.