



# Installation Guide

Linea™ Weatherboard

## EXTERIORS

**Australia** October 2023

**Make sure your information is up to date.**

When specifying or installing Hardie™ products, ensure that you have the current technical information and guides. If in doubt, or you need more information, visit [jameshardie.com.au](http://jameshardie.com.au) or contact James Hardie™ on 13 11 03.

## CONTENTS

<b>1</b>	<b>INTRODUCTION</b>	<b>1</b>
<b>2</b>	<b>SAFE WORKING PRACTICES</b>	<b>2</b>
	Warning	2
	Recommended safe working practices	2
	Storage and handling	2
<b>3</b>	<b>DESIGN CONSIDERATIONS</b>	<b>2</b>
	Framing	3
	Fasteners	3
<b>4</b>	<b>PRODUCTS AND ACCESSORY DETAILS</b>	<b>4</b>
	Components	4
	Timber and Steel Frame Accessory Options	5
<b>5</b>	<b>WEATHERBOARD INSTALLATION</b>	<b>6</b>
<b>6</b>	<b>CONSTRUCTION DETAILS</b>	<b>7</b>
	Junction Details	7
	External Corner Details	7
	Internal Corner Details	8
	Window Details	9
<b>7</b>	<b>FINISHES AND MAINTENANCE</b>	<b>10</b>
	Surface Preparation	10
	Painting	10
	Maintenance	10
<b>8</b>	<b>PRODUCT INFORMATION</b>	<b>10</b>

## Made in Australia

### SCOPE

This guide covers the use of Linea™ Weatherboard in a residential wall application over a seasoned timber wall frame or a light-gauge steel frame.

### CODEMARK CERTIFICATION

The CodeMark Certification Scheme is a voluntary third-party building product certification scheme that authorises the use of new and innovative products in specified circumstances in order to facilitate compliance with Volume 1 and 2 of the NCC.

Linea™ Weatherboard has been certified under the CodeMark scheme (Certificate Number CM40225) and available at [www.jameshardie.com.au](http://www.jameshardie.com.au). This certificate can be provided to building certifiers and other regulatory authorities to facilitate the assessment of the product compliance or used to verify the suitability of the product for certain applications.



## Linea™ Weatherboard

The beauty of clean lines and a modern look.

A deep shadow weatherboard for contemporary homes.

## 1 Introduction

The clean horizontal lines of Linea™ Weatherboard works beautifully on the expansive external walls of modern architecture. Ideal for creating a Hamptons or coastal inspired look when combined with contrasting Hardie™ Axent™ Trim in new homes or renovations, Linea can also be confidently painted in dark colours.



Innovative and durable, Linea™ Weatherboard is resistant to shrinking, swelling and cracking and will hold paint longer than wood.

Featuring the distinctive charm of a deep shadow weatherboard without the maintenance of timber, the unmatched thickness for fibre cement weatherboard of 16mm which also enable handy tongue and groove short ends for clean butt joins even off-stud.

### IMPORTANT NOTES

1. Failure to install, finish or maintain this product in accordance with applicable building codes, regulations, standards and James Hardie's written application instructions may lead to personal injury, affect system performance, violate local building codes, and void Hardie™ product warranty.
2. All warranties, conditions, liabilities (direct, indirect or consequential) and obligations whether arising in contract, tort or otherwise other than those specified in James Hardie's product warranty are excluded to the fullest extent allowed by law. For Hardie™ product warranty information and disclaimers about the information in this guide, visit [www.jameshardie.com.au](http://www.jameshardie.com.au).
3. The builder must ensure the product meets aesthetic requirements before installation. James Hardie will not be responsible for rectifying aesthetic surface variations following installation.

## 2 Safe Working Practices

### WARNING - DO NOT BREATHE DUST AND CUT ONLY IN WELL VENTILATED AREA

Fibre cement products manufactured by James Hardie contain sand, a source of respirable crystalline silica. **May cause cancer if dust from product is inhaled. Causes damage to lungs and respiratory system through prolonged or repeated inhalation of dust from product.** Intact fibre cement products are not expected to result in any adverse toxic effects. The hazard associated with fibre cement arises from the respirable crystalline silica present in dust generated by activities such as cutting, rebating, drilling, routing, sawing, crushing, or otherwise abrading fibre cement, and when cleaning up, disposing of or moving dust. When doing any of these activities in a manner that generates dust, follow Hardie™ instructions and best practices to reduce or limit the release of dust, warn others in the area and consider rotating personnel across the cutting task to further limit respirable silica exposure. If using a dust mask or respirator, use an AS/NZS1716 P1 filter and refer to Australian/New Zealand Standard 1715:2009 Selection, Use and Maintenance of Respiratory Protective Equipment for more extensive guidance and more options for selecting respirators for workplaces. For further information, refer to our installation instructions and Safety Data Sheets available at [www.jameshardie.com.au](http://www.jameshardie.com.au). FAILURE TO ADHERE TO OUR WARNINGS, SAFETY DATA SHEETS, AND INSTALLATION INSTRUCTIONS MAY LEAD TO SERIOUS PERSONAL INJURY OR DEATH.

#### James Hardie Recommended Safe Working Practices

##### CUTTING OUTDOORS

1. Position cutting station so wind will blow dust away from the user or others in working area.
2. Warn others in the area to avoid dust.
3. Consider rotating personnel across cutting tasks to further limit respirable silica exposures.
4. Use one of the following methods based on the required cutting rate:  
**Best** ■ Villaboard™ knife ■ Hand guillotine ■ Fibreshear  
**Better** ■ Position the cutting station in a well-ventilated area. Use a dust reducing circular saw equipped with Hardie™ Blade Saw Blade or comparable fibre cement blade and well maintained M-class vacuum or higher with appropriate filter for capturing fine (respirable) dust. Wear a properly-fitted, approved dust mask or respirator (minimum P1).

##### CUTTING INDOORS

- Cut only using Villaboard™ knife, hand guillotine or fibreshears (manual, electric or pneumatic).
- Position cutting station in a well-ventilated area.

##### DRILLING/OTHER MACHINING

When drilling or machining you should always wear a P1 dust mask and warn others in the immediate area.

##### IMPORTANT NOTES

1. For maximum protection (lowest respirable dust production) James Hardie recommends always using best practice cutting methods where feasible.
2. NEVER use a power saw indoors or in a poorly ventilated area.
3. ALWAYS use a dust reducing circular saw equipped with a sawblade specifically designed to minimise dust creation when cutting fibrecement - preferably a sawblade that carries the Hardie™ Blade logo or one with at least equivalent performance - connected to a M class or higher vacuum.
4. NEVER dry sweep - Use wet suppression, or an M class vacuum or higher with appropriate filter.
5. NEVER use grinders.
6. ALWAYS follow tool manufacturers' safety recommendations.
7. ALWAYS wear a properly fitted, approved dusk mask, P1 or higher

##### DUST MASKS AND RESPIRATORS

As a minimum, an AS/NZS1716 P1 respirator must be used when doing any activity that may create dust. For more extensive guidance and options for selecting respirators for workplaces please refer to Australian/New Zealand Standard 1715:2009 "Selection, Use and Maintenance of Respiratory Protective Equipment". P1 respirators should be used in conjunction with the above cutting practices to minimise dust exposure. For further information, refer to Safety Data Sheet (SDS) available at [www.jameshardie.com.au](http://www.jameshardie.com.au). If concern still exists about exposure levels or you do not comply with the above practices, you should always consult a qualified industrial hygienist or contact James Hardie for further information.

### STORAGE AND HANDLING

To avoid damage, all Hardie™ building products should be stored with edges and corners of the product protected from chipping. Hardie™ building products must be installed in a dry state and protected from weather during transport and storage. The product must be laid flat under cover on a smooth level surface clear of the ground to avoid exposure to water, moisture, etc.

## 3 Design Considerations

All design and construction must comply with the appropriate requirements of the current National Construction Code (NCC) and other applicable regulations and standards.

### Slab and Footings

The slab and footings on which the building is situated must comply with AS 2870 'Residential slabs and footings – Construction' and the requirements of the NCC.

### Ground Clearances

Install Linea™ Weatherboard with a minimum 150mm clearance to the earth on the exterior of the building or in accordance with local building codes if greater than 150mm is required. Maintain a minimum 50mm clearance between the external cladding and roofs, decks, paths, steps and driveways.

Adjacent finished grade must slope away from the building in accordance with local building codes, typically a minimum slope of 50mm over the first metre.

Do not install external cladding such that it may remain in contact with standing water.

### NOTE

Greater clearance may be required in order to comply with termite protection provisions, see below for more information.

### Termite Protection

The NCC specifies the requirements for termite barriers. Where the exposed slab edge is used as part of the termite barrier system, a minimum of 75mm of the exposed slab edge must be visible to permit ready detection of termite entry.

### Structural Bracing

Linea™ Weatherboard can be installed to provide wall bracing against lateral forces due to wind. For further information, refer to the Hardie™ Structural Bracing Application Guide or Contact James Hardie on 13 11 03.

### Fire Rated Walls

Linea™ Weatherboard can be used as part of a fire rated wall when constructed with additional fire rated linings as specified in Hardie™ Fire and Acoustically Rated Walls Application Guide and Technical Specification or the Hardie™ Smart Boundary Wall System Design Guide. The length of fasteners must be increased for the additional linings.

### Moisture Management

It is the responsibility of designer or specifier to identify moisture related risks associated with any particular building design. Wall construction design must effectively manage moisture, accounting for both the interior and exterior environments of the building, particularly in buildings that have a higher risk of wind driven rain penetration or that are artificially heated or cooled.

In addition, all wall openings, penetrations, junctions, connections, window sills, heads and jambs must incorporate appropriate flashing and waterproofing. Materials, components and their installation that are used to manage moisture in framed wall construction must, at a minimum, comply with the requirements of relevant standards and the NCC.

### Joint Location

Before starting the installation of Linea™ Weatherboard, plan the location of vertical and horizontal joints to follow the house design. To achieve this, consider aligning the joints with key building features such as windows or other opening, or work from the centerline out to the wall edge to achieve symmetry.

## Weather Barrier

A suitable water control membrane must be installed under Hardie™ cladding in accordance with the AS/NZS 4200.2 'Pliable building membranes and underlays – Installation' and NCC requirements.

James Hardie has tested and certified the use of Hardie™ Weather Barrier or RAB™ Board for Climate Zones 2-8 within Australia. Hardie™ Weather Barrier is a Class 4 vapour permeable membrane that delivers a triple-shield of protection to help against external weather penetration, internal condensation management and external heat penetration through its safe-glare reflective layer.

If using an alternate product in lieu of Hardie™ Weather Barrier or RAB™ Board or the project is located in a hot, humid area (Climate Zone 1), the designer must ensure that the product is fit for purpose and it has the following classification in accordance with AS/NZS 4200.1:2017 'Pliable building membranes and underlays – Materials':

TABLE 1

Weather Barrier Classification		
Climate Zone	Water Control Classification	Vapour Control Category
2-8	Water Barrier	Vapour Permeable (Class 3 or 4)
1		Vapour Barrier (Class 1 or 2)

Soft compressible insulation installed between the front of the wall studs and directly behind the external cladding can cause installation issues and is thus not recommended.

## Flashing

All wall openings, penetrations, intersections, connections, window sills, heads and jambs must be flashed prior to cladding installation.

TABLE 2

General Framing Requirements				
Type	Timber		Steel	
<b>Design</b>	Use of timber framing must be in accordance with AS 1684 and the framing manufacturer's specifications		Use of steel framing must be in accordance with NASH standard for Residential and Low-Rise Steel Framing Part 1: Design Criteria and the framing manufacturer's specifications.	
<b>Durability</b>	Timber used for house construction must have the level of durability appropriate for the relevant climate and expected service life. Reference AS 1684.2 'Residential timber-framed construction'.		The steel framing must have the appropriate level of durability required to prevent corrosion, particularly in coastal areas.	
<b>Tolerances</b>	Ensure frame is square and work from a central datum line. A suggested maximum tolerance of 4mm in any 3000mm length of frame will give best results.			
<b>Thermal Break Requirement</b>	Not required.		For steel frames, the NCC Sections J3D6 and 13.2.5 Volumes 1 and 2 respectively, state for both residential and commercial buildings a thermal break with an R 0.2m <sup>2</sup> K/W must be installed behind external cladding where the cladding and internal lining make direct contact with the same steel frame. For information relating to the suitability of Hardie™ Break Thermal Strip, refer to the Hardie™ Break Installation Guide at <a href="http://ww.jameshardie.com.au">ww.jameshardie.com.au</a> . Alternatively, vented cavity installation using minimum 70x350mm timber battens or off-stud Hardie™ Cavity Battens can be used in these applications.	
Framing specifications				
	Direct Fix	Cavity Fix	Direct Fix	Cavity Fix
<b>BMT</b>		NA	From 0.55 to 1.6mm.	From 0.55 to 1.6mm.
<b>Min. Stud Width</b>	35mm	35mm	Min. 32mm	Min. 32mm
<b>Min. Stud Depth</b>	70mm	70mm	64mm	64mm
<b>Max. Nogging spacing</b>	1350mm	1350mm for on stud batten fixing. 800mm for off stud batten fixing.	1350mm	1350mm when battens are fixed on stud or 800mm when fixed off stud
<b>Battens</b>	N/A	Hardie™ Cavity Battens or minimum MGP10 70 x 35mm timber battens	N/A	Hardie™ Cavity Battens or minimum MGP10 70 x 35mm timber battens

TABLE 3

Maximum Stud & fastener spacing for Linea™ Weatherboard in AS4055 Wind Classification			
Wind Classification	Suitable for Cavity Fixing	Stud Spacing (mm)	
		General Areas of Building	Within 1200mm of Building Edges
N1, N2, N3/C1	YES	600	600
N4/C2	YES*	600	450
N5/C3	NO	600	450
N6/C4	NO	450	300

### NOTES:

\*Battens must be fixed on-stud with a fastener spacing of 300mm maximum.

## FRAMING

### General

Linea™ Weatherboard may be specified for timber-framed or steel-framed structures. The general framing requirements for installation are given in Table 2. Please ensure the frame design considers correct load transfer between the different wall components.

## FASTENERS

### General

All nails must be driven flush. For more information and advice, Ask James Hardie™ on 13 11 03.

### Fastener Durability (Including Coastal Areas)

Fasteners must have the appropriate level of durability and be fully compatible with all other materials required for the intended project. In areas within 1km of a coastal area, areas subject to salt spray and other corrosive environments, class 4 fasteners must be used.

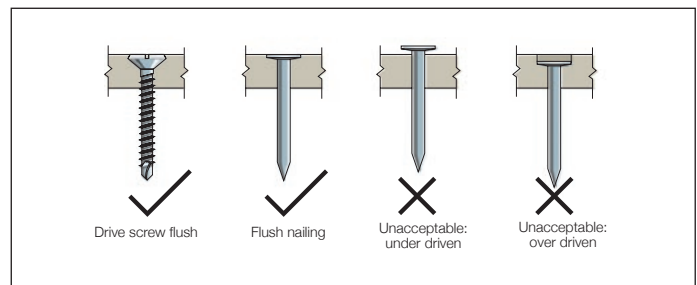

### FASTENER DEPTH

TABLE 4

Maximum span for Hardie™ Cavity Batten or timber batten			
Batten	Dimensions (mm)	Max. Span (mm)	
		Timber Frame	Steel Frame
Hardie™ Cavity Batten	70 x 19	800	800*
Timber Battens	70 x 35	1350*	800*

### NOTES:

\*Requires using two nails per fixing point when installing the battens off-stud. Refer to the Product and Accessories Details on page 5 for fastener and fixing requirements.

A continuous bead of Hardie™ Joint Sealant is required between the vertical battens and the back of the cladding in all cases.

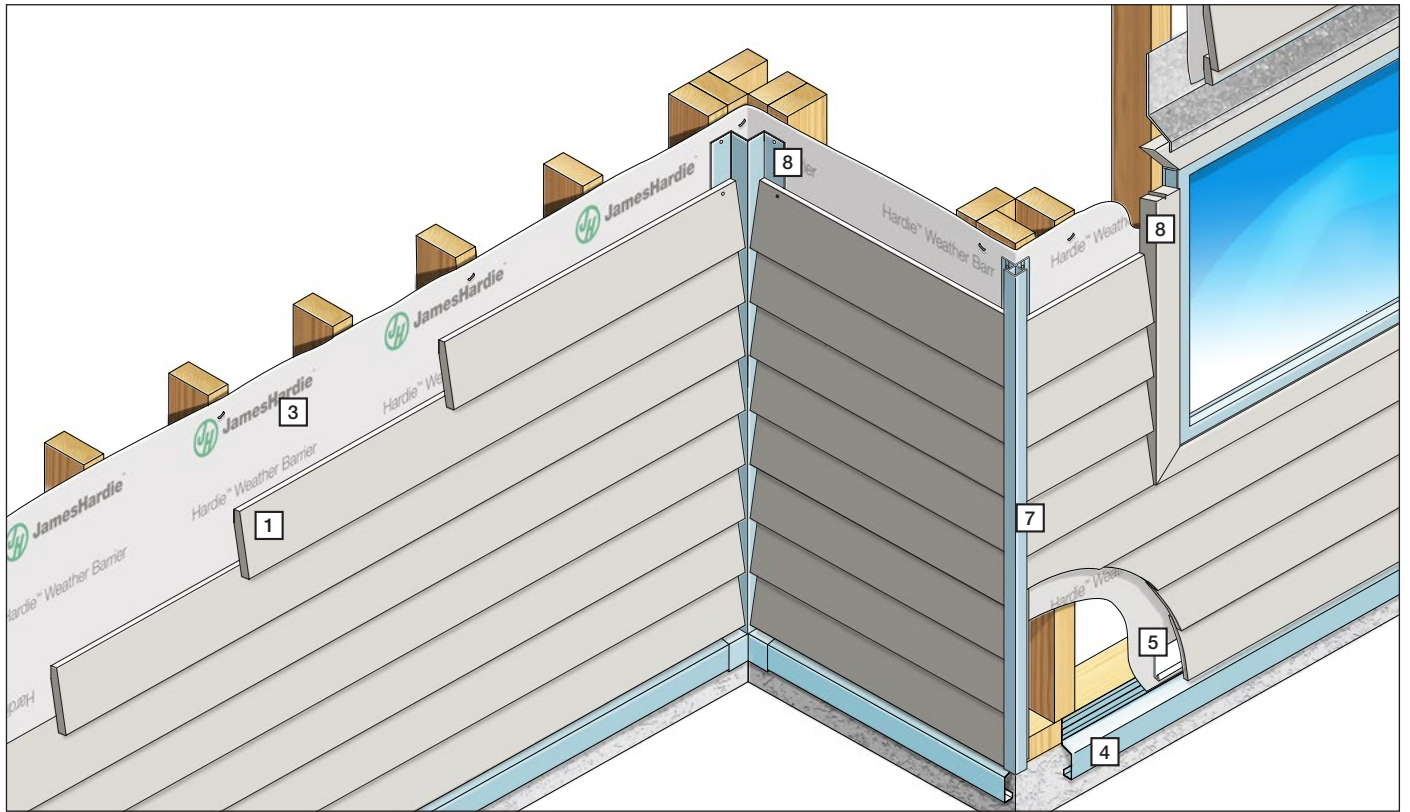

# 4 Products and Accessory Details





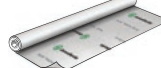

## COMPONENTS

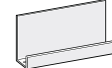
1	Linea™ Weatherboard (16mm thick)	Product Code	Length (mm)	Width (mm)	Mass kg/lin m	Mass kg/m <sup>2</sup>	No. of planks/metre height	Pallet Size	Effective Coverage (mm)
	Linea™ Weatherboard are a pre-primed horizontal weatherboard with deep shadow lines.	403930	4200*	150	2.8	23.2	8.3	90	0.50
		403912	4200*	180	3.4	22.7	6.7	90	0.63

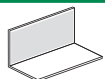

\*Length is 4200mm plus 5mm for the tongue and groove (T & G) making the length 4205mm overall.

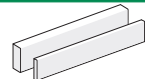
<b>2 Hardie™ Joint Sealant</b>  General purpose polyurethane exterior grade joint sealant. Pack Size: 20/Box. Product Code: 305534 300ml Cartridge Product Code: 305672 600ml Sausage Coverage: 2.67m <sup>2</sup> /100ml (5mm dia bead)	<b>3 Hardie™ Weather Barrier</b>  Water barrier and vapour permeable membrane. Unit size: 2.75 x 30m. Pack Size: 1 Each. Product Code: 305664 Coverage: 82.5m <sup>2</sup> per roll	<b>3 RAB™ Board</b>  Airtight, weatherproof, vapour permeable and non-combustible rigid 6mm fibre-cement sheathing. 40 per pack 1200 x 2450mm Prod Code: 402980 1200 x 2750mm Prod Code: 405131 1200 x 3000mm Prod Code: 402981	<b>4 Hardie™ Edge Trim</b>  Powder coated aluminium architectural slab edge solution. Product Codes: Hardie™ Edge Trim (4/pack) 305911 Base Trim Joister (12/pack) 305912 Internal Corner (4/pack) 305913 External Corner (4/pack) 305914	<b>5 Linea™ PVC Starter Strip</b>  A perforated PVC starter strip used to set out the bottom edge of Linea™ Weatherboard at the correct angle. Product Code: 305571 (25/pack) Coverage: Length of horizontal joints / 3000mm
---	---	---	--	---

### Alternative Corner Options

<b>6 Linea™ Aluminium Universal Window Adaptor</b>  A ready to paint extrusion to be used adjacent to windows to finish the edge of Linea™ Weatherboard. 3700mm long. Product Code: 305510 Pack Size: 5	<b>8 Hardie™ Corner Flashing</b>  Manufactured using COLORBOND® steel, used behind cladding at internal and external corners. 75 x 75mm. 3000mm long. Pack Size: 5. Product Code: 305564 Coverage: Height of clad walls x no. of corners / 3000mm	<b>8 Linea™ PVC Box Corner Z Flashing</b>  A PVC flashing for use with Linea™ Weatherboard in conjunction with Hardie™ Axent™ Trim to form external corners. 2700mm long. Pack Size: 25. Product Code: 305570 Coverage: Height of clad walls x no. of corners / 2700mm	<b>8 Hardie™ Axent™ Trim</b>  Material composite trim used for box corners and for trim around windows and doors. Pack Size: 1. For internal corners: 45 x 38mm. 3000mm long. Product Code: 405261 For external corners: 45 x 19mm. 3000mm long. Product Code: 405260	<b>8 Hardie™ Aluminium Internal Corner Mould</b>  A ready to paint extrusion to be used with Linea™ Weatherboard to create internal corners. 3600mm long. Product Code: 305511 Pack Size: 5 Coverage: Height of wall x no. of external corners / 3600mm
--	--	---	--	--

### External Corner Options

<b>7 Linea™ Aluminium External Slimline Boxed Corner</b>  A ready to paint extrusion to be used with Linea™ Weatherboard to create external boxed corners. 3600mm long. Caps available to seal the bottom. Product Code: 305512 Pack Size: 5 Coverage: Height of wall x no. of external corners / 3600m	<b>7 Linea™ Aluminium Corner Soaker</b>  A ready to paint aluminium external corner soaker for use with 150mm & 180mm wide Linea™ Weatherboard. Box Size per kind: 100. 150mm Soaker Product Code: 305574 180mm Soaker Product Code: 305572
--	---

† All dimensions and masses are approximate and subject to manufacture tolerances. Masses are based on equilibrium moisture content of product.

# 4 Products and Accessory Details cont.

Linea™ Weatherboard can be fixed either to timber or steel frames.

Depending on the fixing method and substructure, there will be different components required, these are:

## OPTION 1: DIRECT FIX TIMBER FRAME

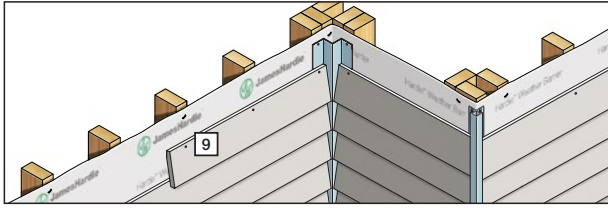

**9 Concealed Nailing Cladding to Frame**

40 x 2.8mm fibre cement nail  
Class 3\* minimum finished flush with board surface.  
Not supplied by James Hardie.

**9 Face Nailing Cladding to Frame**

60 x 3.15mm bullet head nails. Class 3\* minimum nails may be driven through both thicknesses at board lap without re-drilling. Stainless steel nails will require pre-drilling. Use a 3.0mm drill bit.  
Not supplied by James Hardie.

## OPTION 2: CAVITY FIX - TIMBER FRAME

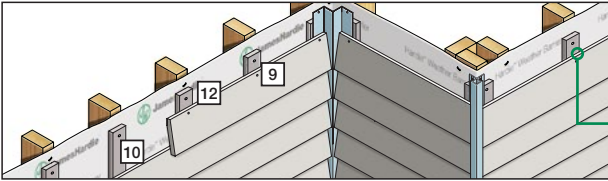

**10 Battens**

**12 Nails to fix batten to frame\***

**9 Fibre Cement Nails to fix cladding to battens**

### When using Hardie™ Cavity Battens

Fibre cement batten used to fix external cladding to steel or timber frame. Pack Size: 96  
Size: 70 x 19 x 3000mm.  
Product Code: 405307

2.8 x 65mm long ring shank nail or 75 x 2.8mm D or round head galvanised smooth shank nail.  
Not supplied by James Hardie.

2.8 x 30mm corrosion resistant fibre cement nail.  
Not supplied by James Hardie.

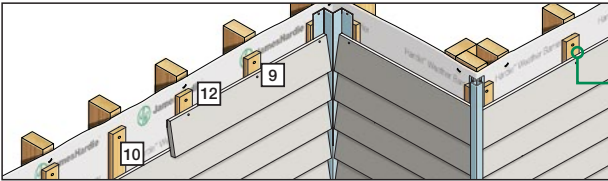

### When using 70 x 35mm Timber Battens

Timber batten used to fix external cladding to steel or timber frame.  
Not supplied by James Hardie.

Two 75 x 3.06mm D Head Class 3 nails per fixing.  
Not supplied by James Hardie.

2.8 x 30mm corrosion resistant fibre cement nail.  
Not supplied by James Hardie.

## OPTION 3: DIRECT FIX STEEL FRAME

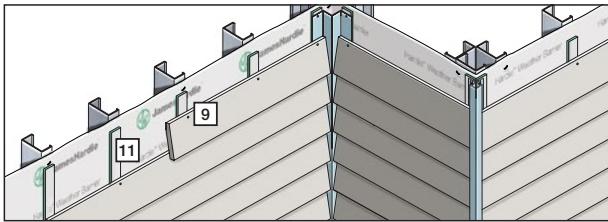

**11 Hardie™ Break Thermal Strip**

Refer to the Hardie™ Break Thermal Strip install guide.

NCC requirement used behind external cladding when fixed directly to steel frame. Size: 43 x 12 x 2750mm. 45 per pack.  
Product Code: 305612

**FOR CONCEALED NAILING**

**9 Hardie™ Drive Screw 41mm long\***

A class 3 self-tapping wing-tipped screw for fastening to 0.5mm to 1.6mm BMT light gauge steel frames. 1000 per box. Product Codes: 305984 (loose) 305982 (collated)

**FOR FACE NAILING**

**9 52mm special wing screw by TRI-FIX\***

For 0.55 - 1.2mm BMT steel framing. Available in Class 3 (hot-dipped galvanised) and stainless steel.  
Not supplied by James Hardie.

## OPTION 4: CAVITY FIX - STEEL FRAME

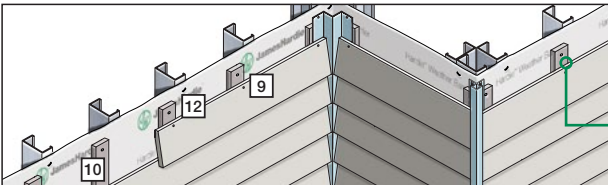

**10 Battens**

**12 Screws to fix batten to frame\***

**9 Fibre Cement Nails to fix cladding to battens**

### When using Hardie™ Cavity Battens

Fibre cement batten used to fix external cladding to steel or timber frame. Pack Size: 96  
Size: 70 x 19 x 3000mm.  
Product Code: 405307

Two Hardie™ Drive Screws - Class 3 self-tapping wing-tipped screw for fastening to 0.5mm to 1.6mm BMT light gauge steel frames. 1000 per box. Product Codes: 305984 (loose) 305982 (collated).

2.8 x 30mm corrosion resistant fibre cement nail.  
Not supplied by James Hardie.

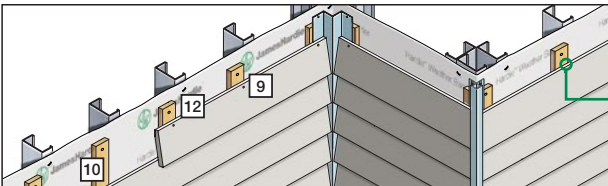

### When using 70 x 35mm Timber Battens

Timber batten used to fix external cladding to steel or timber frame.  
Not supplied by James Hardie.

Two 10-24 x 65mm Class 3 self-drilling CSK-Head screws per fixing.  
Not supplied by James Hardie.

2.8 x 30mm corrosion resistant fibre cement nail.  
Not supplied by James Hardie.

## OPTION 4: CAVITY FIX - BRICK WALL

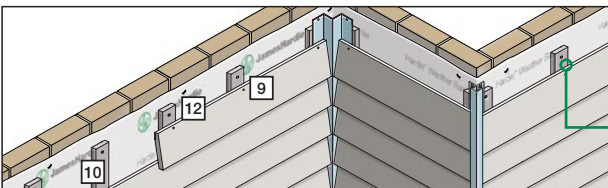

**10 Battens**

**12 Screws to fix battens to brick wall**

**9 Fibre Cement Nails to fix cladding to battens**

### When using Hardie™ Cavity Battens

Fibre cement batten used to fix external cladding to steel or timber frame. Pack Size: 96. Size: 70 x 19 x 3000mm. Product Code: 405307

DeWalt 6mm Blue-Tip 2 Screw-Bolt™ with a minimum embedment of 40mm.†  
Not supplied by James Hardie.

2.8 x 30mm corrosion resistant fibre cement nail.  
Not supplied by James Hardie.

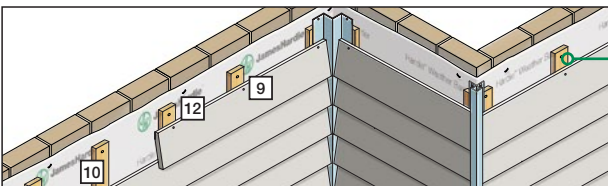

### When using 70 x 35mm Timber Battens

Timber batten used to fix external cladding to steel or timber frame.  
Not supplied by James Hardie.

DeWalt 6mm Blue-Tip 2 Screw-Bolt™ with a minimum embedment of 40mm.†  
Not supplied by James Hardie.

2.8 x 30mm corrosion resistant fibre cement nail.  
Not supplied by James Hardie.

\* In coastal areas and other corrosive environments class 4 fasteners must be used. All other areas require minimum class 3.

† A structural engineer must determine whether the substrate is adequate to hold the proposed anchors, Hardie™ Cavity Batten or Timber Batten and the Hardie™ Cladding Loads. The anchor bolt connecting the battens to the concrete or masonry wall shall have a working load capacity of 0.7kN, equivalent to an Ultimate Limit State phi-R capacity of 1.05kN.

# 5 Weatherboard Installation Process - Direct Fix\*

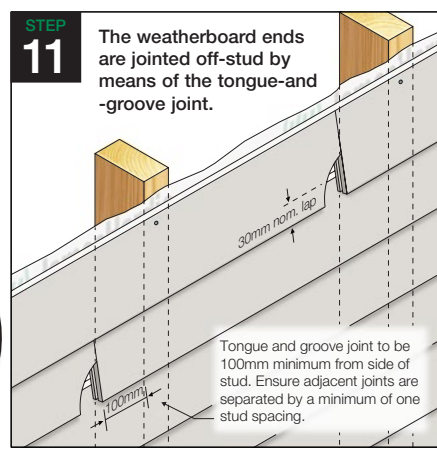
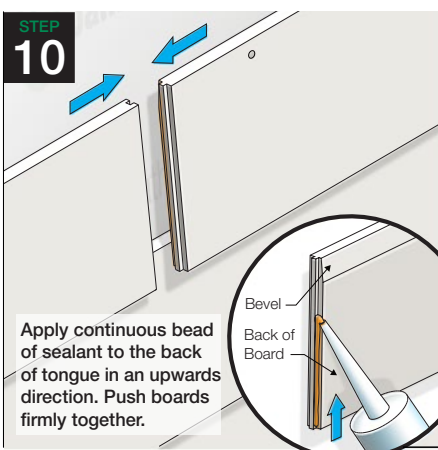
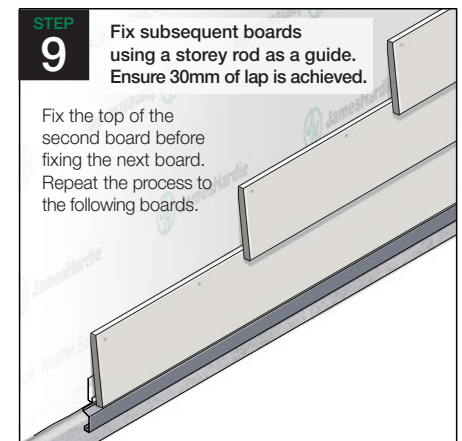
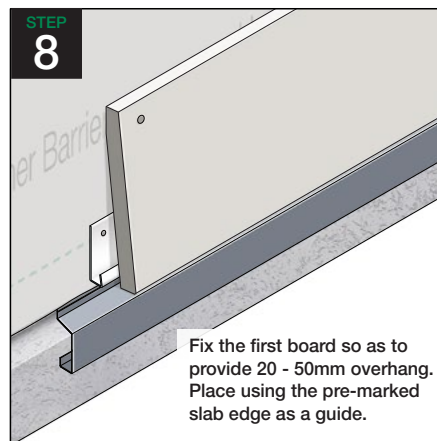
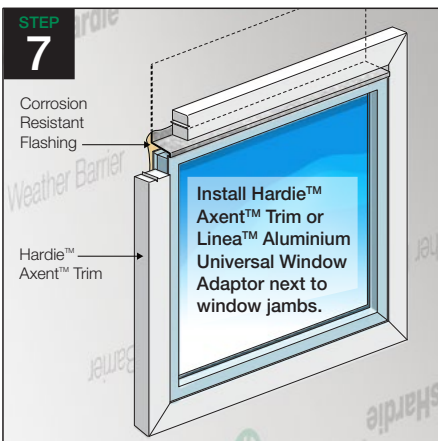
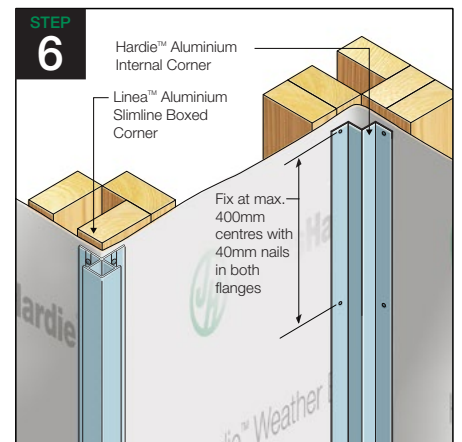
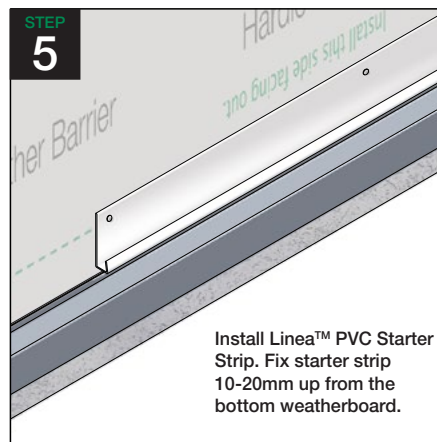
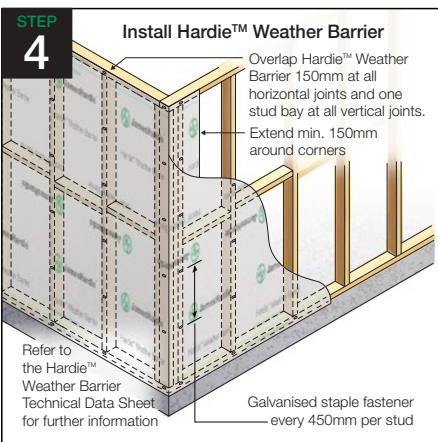
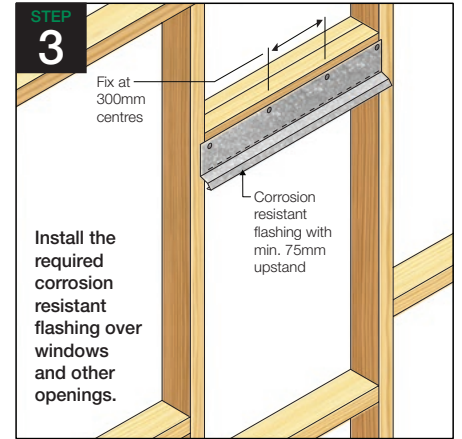
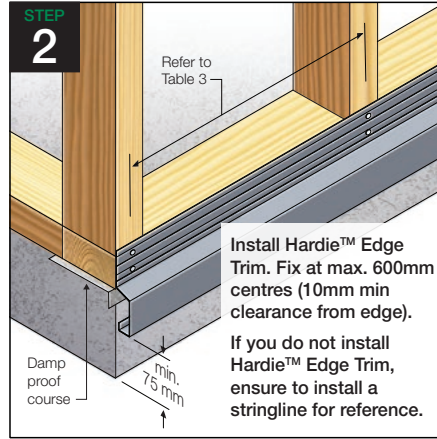

\*This is an overview of the installation process only. It is not a substitute for reviewing this document in its entirety prior to installation.

# 5 Weatherboard Installation Process - Cavity Fix\*

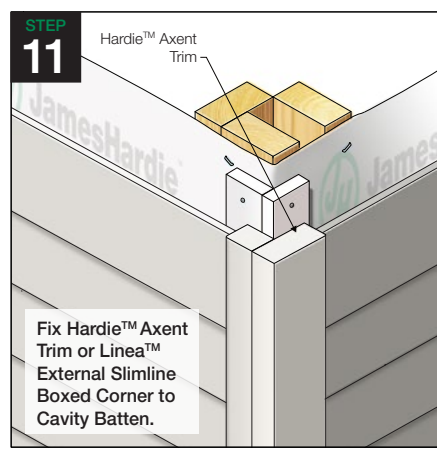
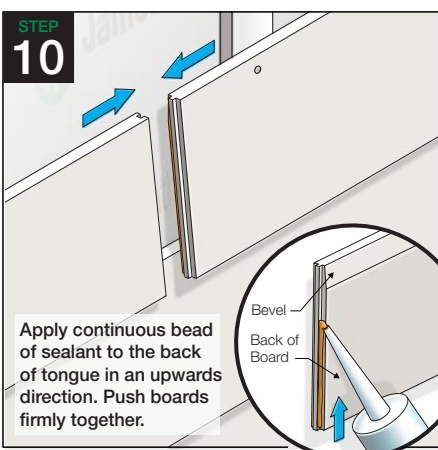
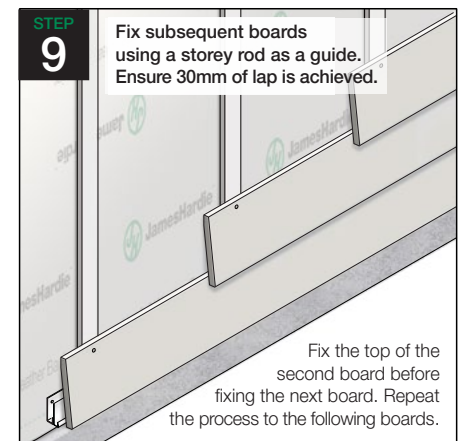
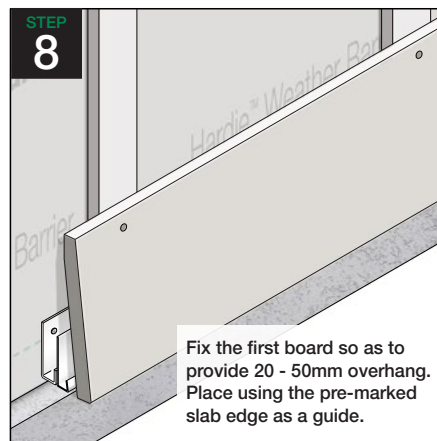
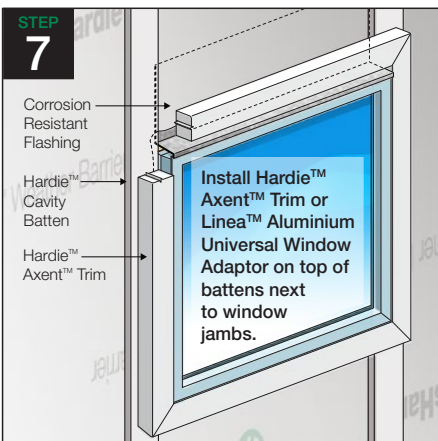
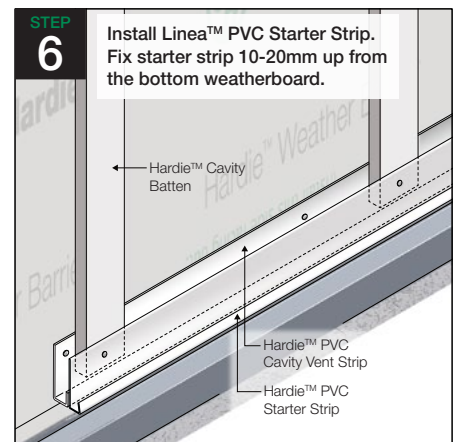
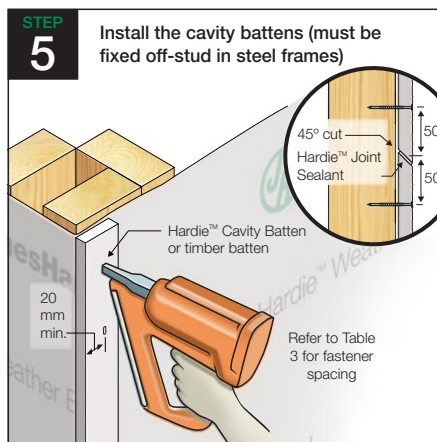
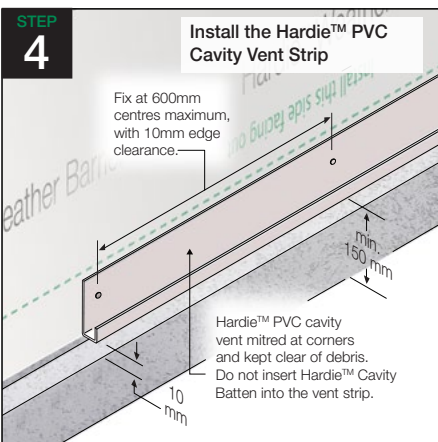
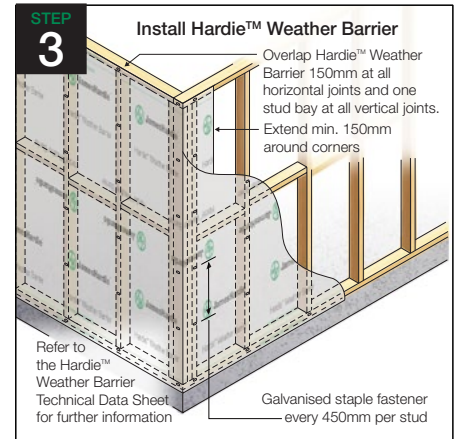
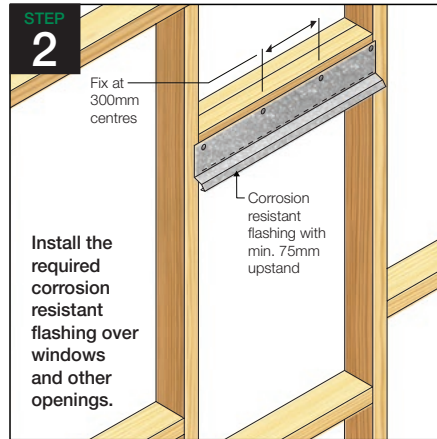

\*This is an overview of the installation process only. It is not a substitute for reviewing this document in its entirety prior to installation.



# 6 Construction Details - Direct Fix

## JUNCTION DETAILS

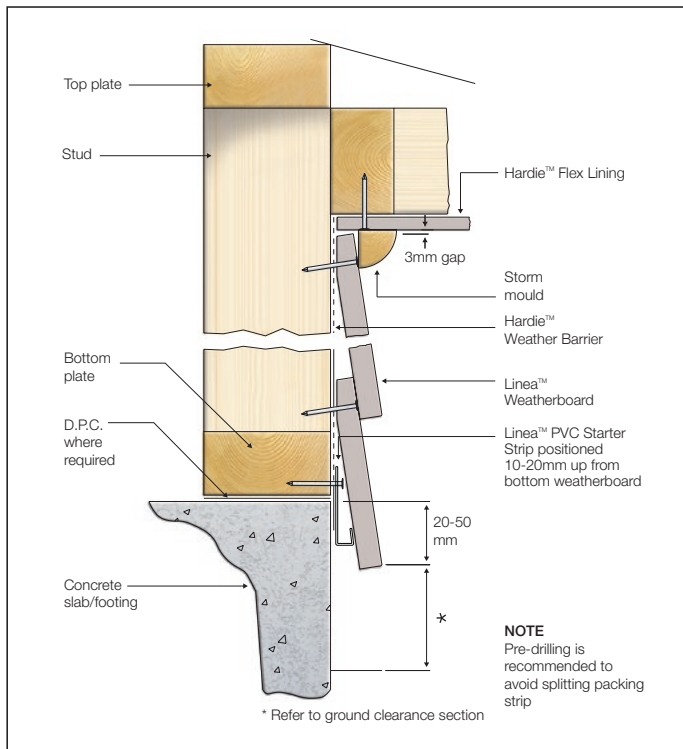

FIGURE 1 SLAB/EAVE JUNCTION DETAIL

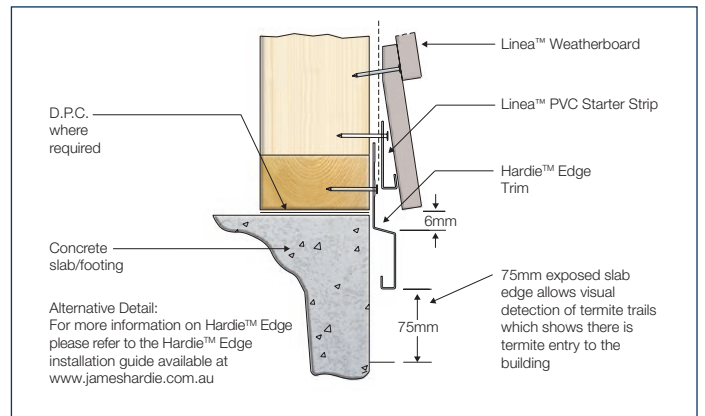

FIGURE 2 SLAB JUNCTION ALTERNATIVE

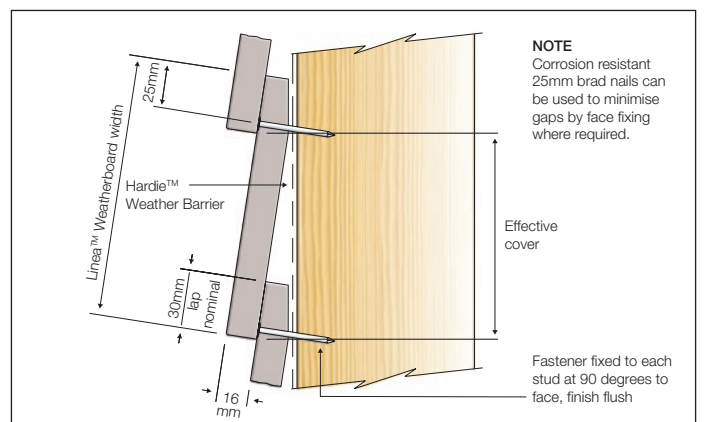

FIGURE 3 CONCEALED FIXING OPTION

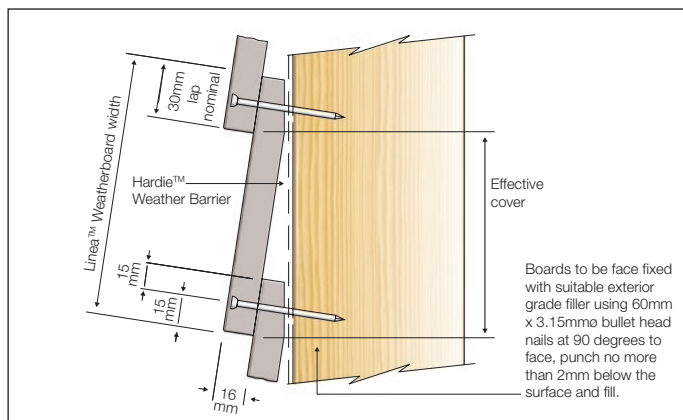

FIGURE 4 FACE FIXING OPTION

## EXTERNAL CORNER DETAILS

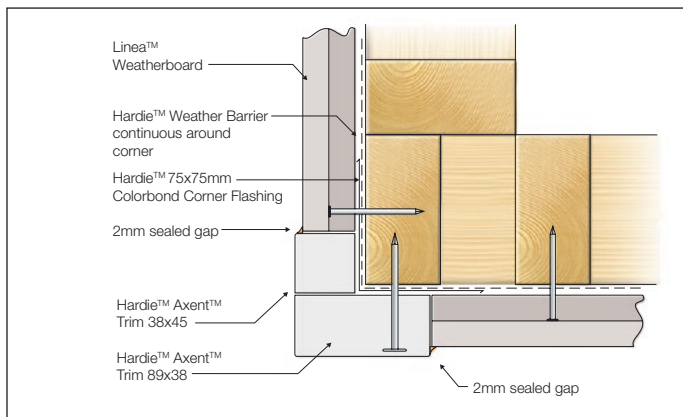

FIGURE 5 EXTERNAL CORNER TRIM OPTION

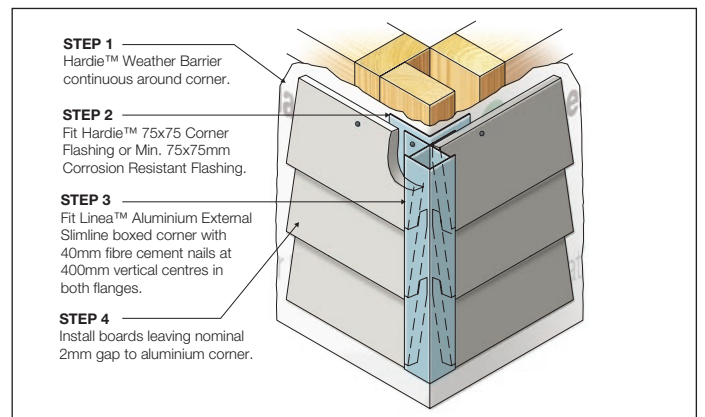

FIGURE 6 EXTERNAL CORNER SLIMLINE BOX CORNER OPTION

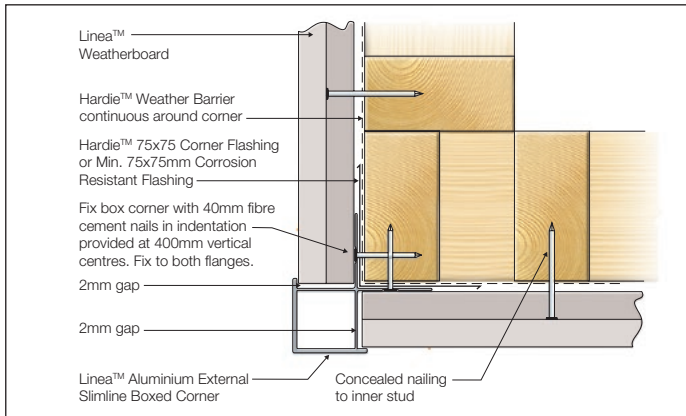

FIGURE 7 EXTERNAL SLIMLINE BOX CORNER DETAIL

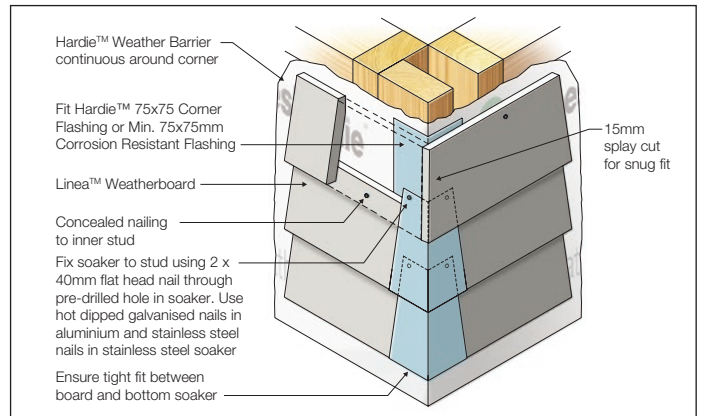

FIGURE 8 EXTERNAL CORNER SOAKERS OPTION

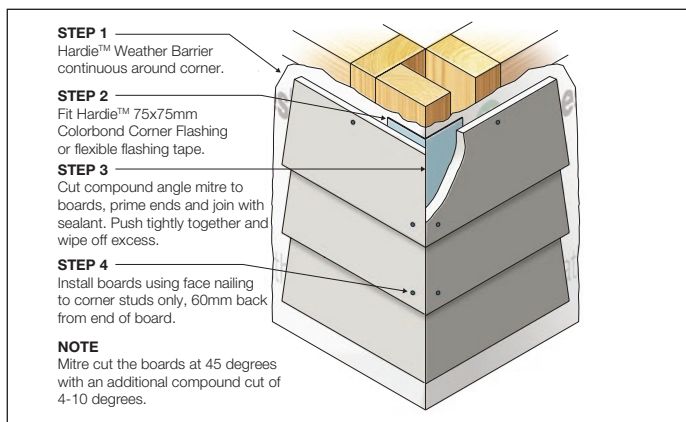

FIGURE 9 EXTERNAL MITRE CORNER OPTION

## INTERNAL CORNER DETAILS

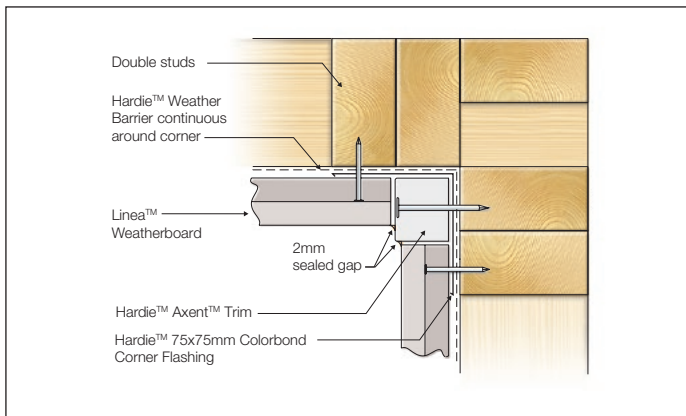

FIGURE 10 INTERNAL CORNER TRIM OPTION

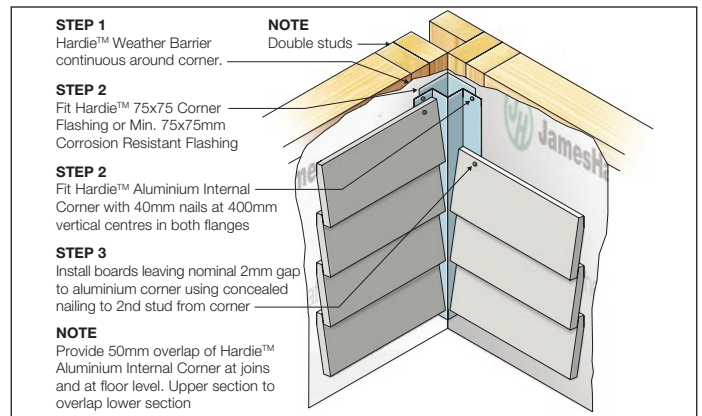

FIGURE 11 INTERNAL CORNER MOULD OPTION

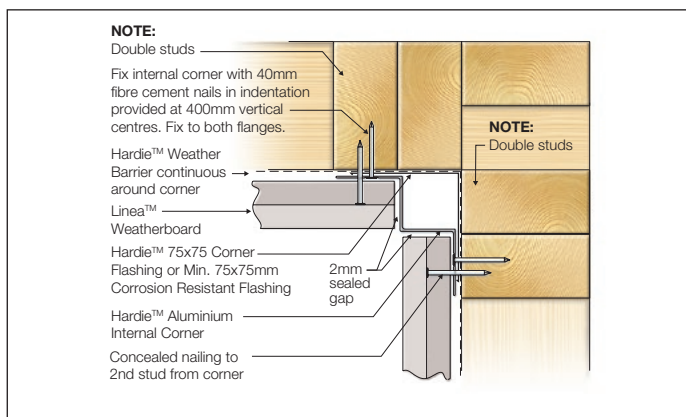

FIGURE 12 INTERNAL CORNER MOULD DETAIL

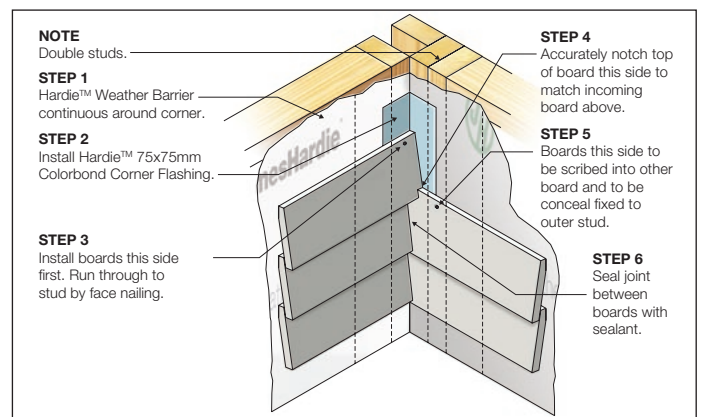

FIGURE 13 INTERNAL CORNER NOTCH & SCRIBE OPTION

# WINDOW DETAILS

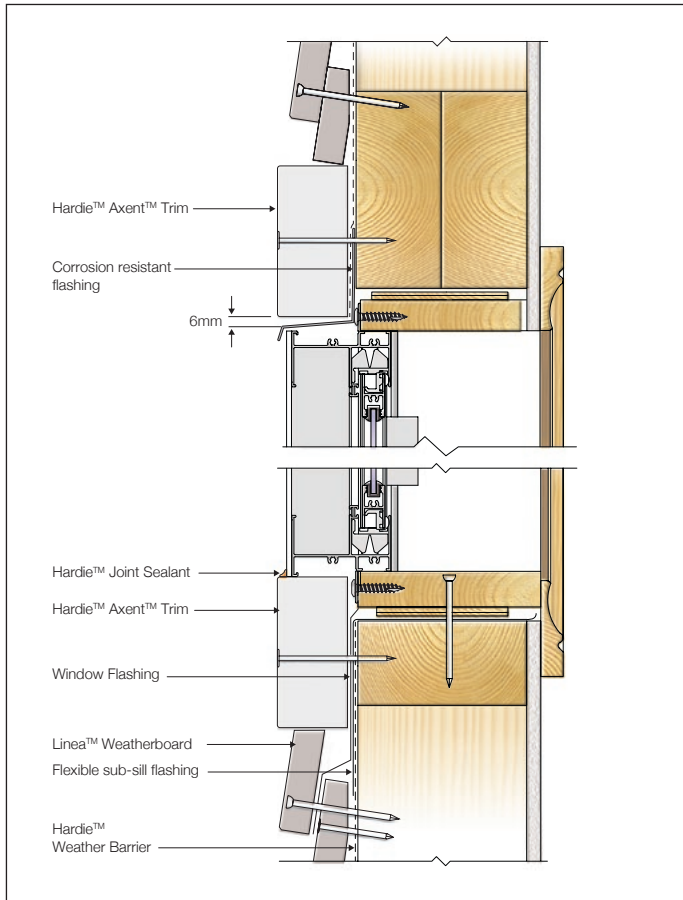

FIGURE 14 WINDOW HEAD AND SILL - TRIM OPTION

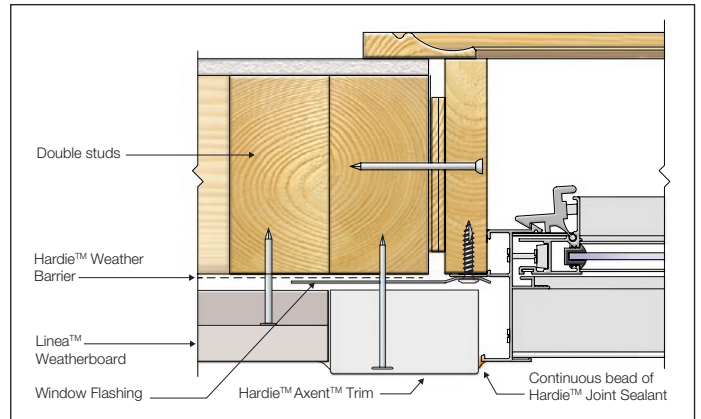

FIGURE 15 WINDOW JAMB - TRIM OPTION

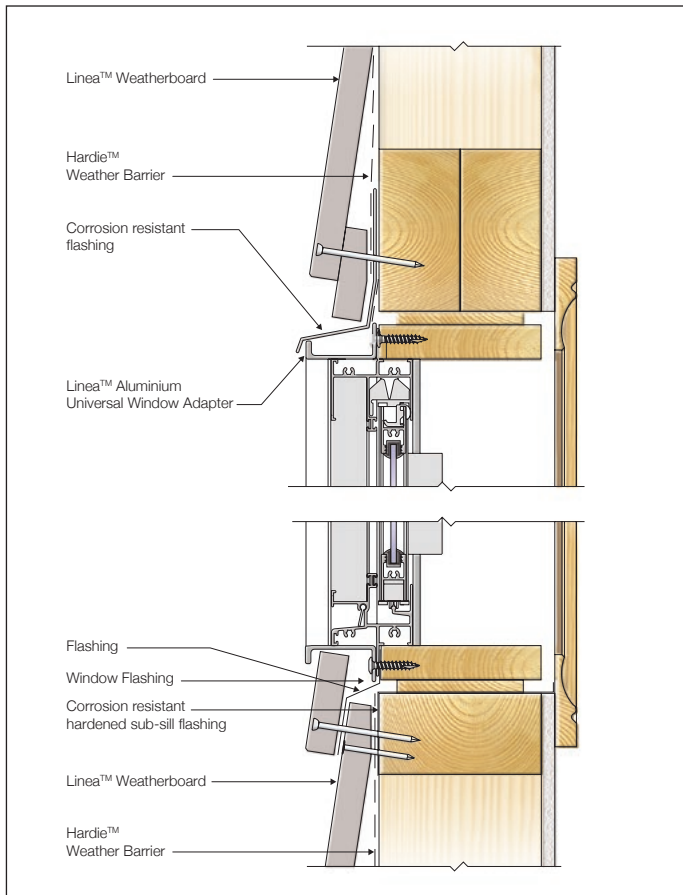

FIGURE 16 WINDOW HEAD AND SILL - LINEA™ WINDOW ADAPTER OPTION

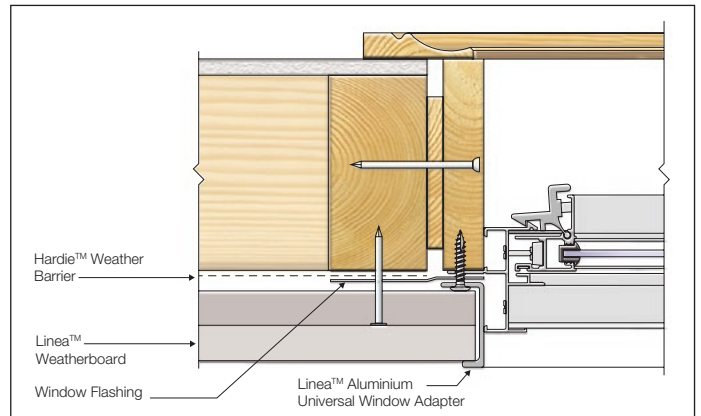

FIGURE 17 WINDOW JAMB - LINEA™ WINDOW ADAPTER OPTION

# 6 Construction Details - Cavity Fix

## JUNCTION DETAILS

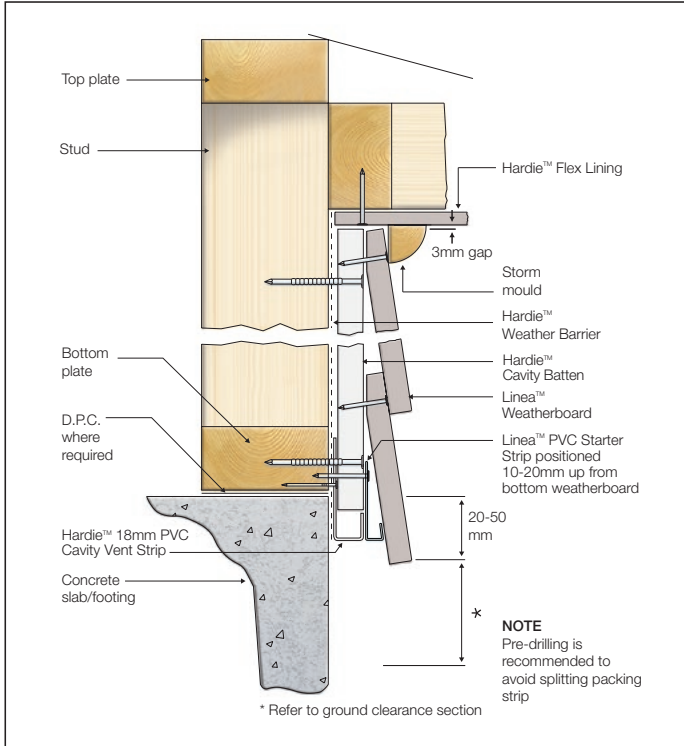

FIGURE 1 SLAB/EAVE JUNCTION DETAIL

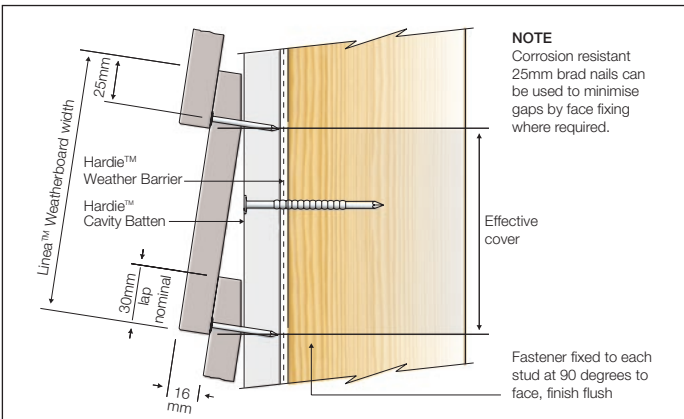

FIGURE 4 CONCEALED FIXING OPTION

## EXTERNAL CORNER DETAILS

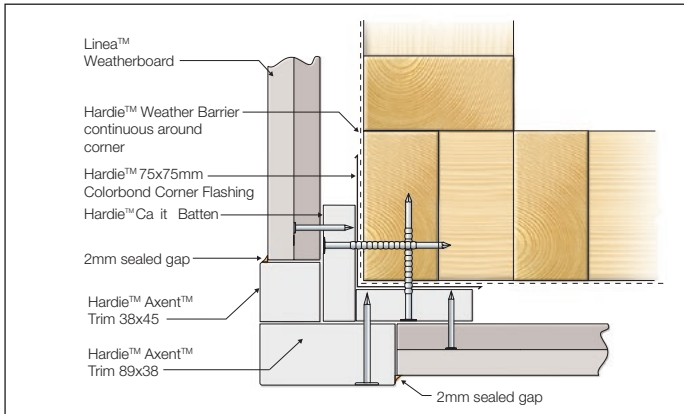

FIGURE 5 EXTERNAL CORNER TRIM OPTION

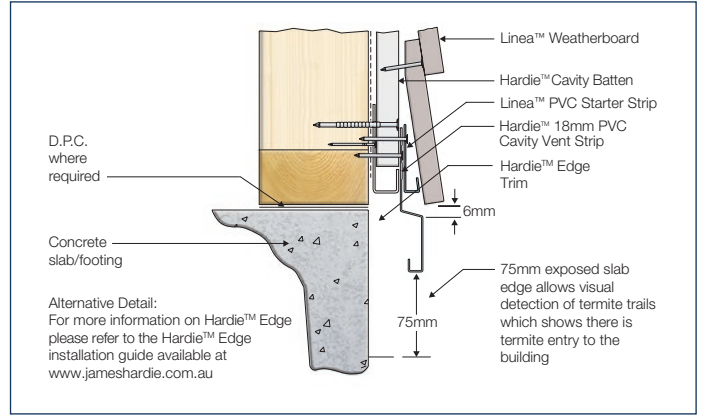

FIGURE 2 SLAB JUNCTION ALTERNATIVE - HARDIE™ EDGE TRIM

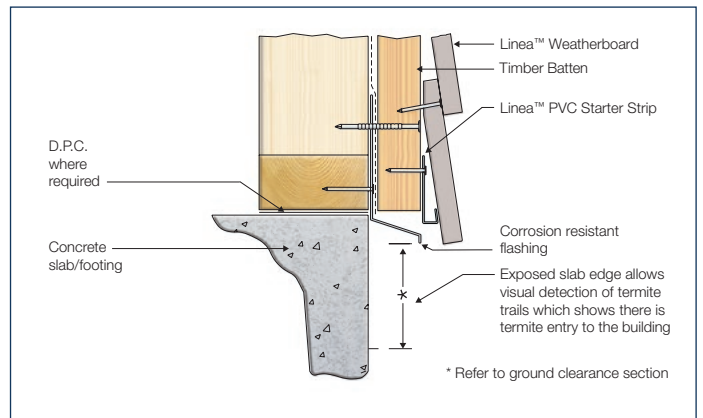

FIGURE 3 SLAB JUNCTION ALTERNATIVE - TIMBER BATTEN

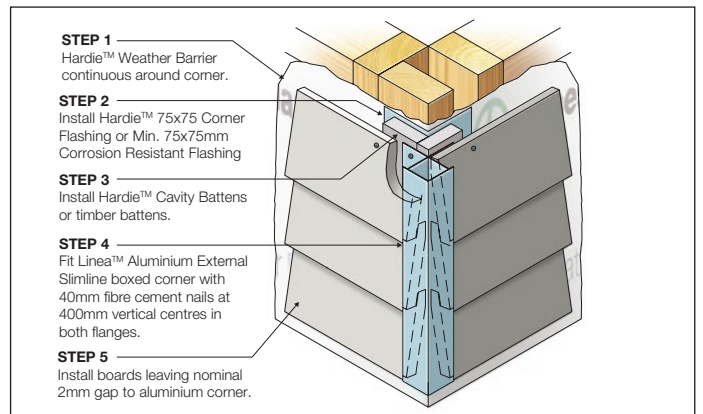

FIGURE 6 EXTERNAL CORNER SLIMLINE BOX CORNER OPTION

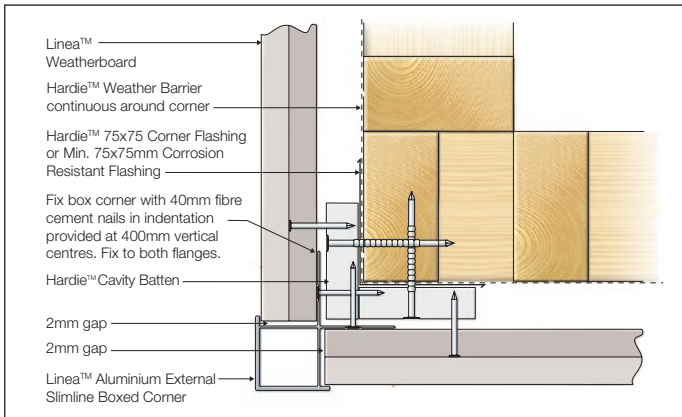

FIGURE 7 EXTERNAL SLIMLINE BOX CORNER DETAIL

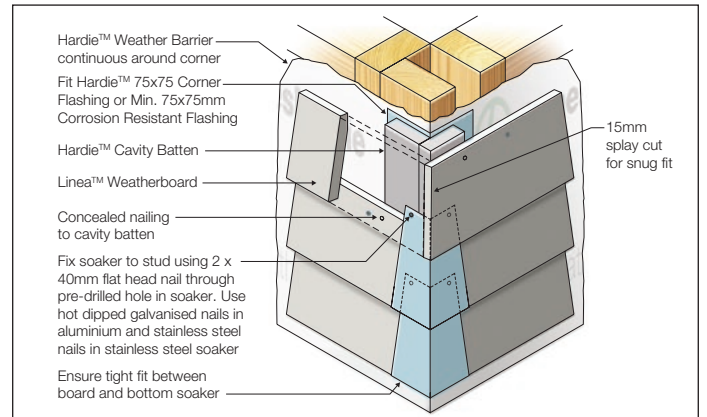

FIGURE 8 EXTERNAL CORNER SOAKERS OPTION

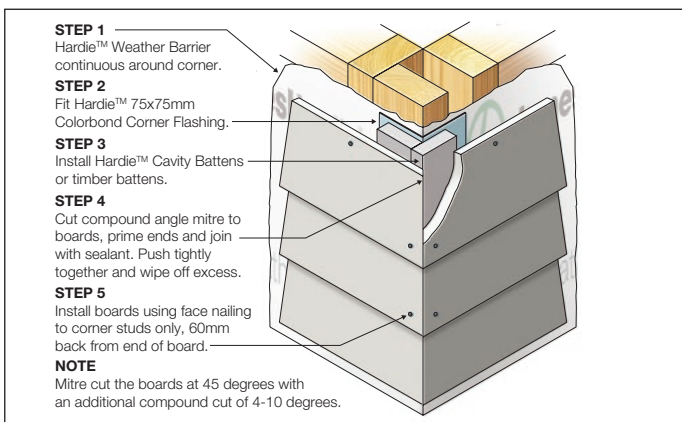

FIGURE 9 EXTERNAL MITRE CORNER OPTION

## INTERNAL CORNER DETAILS

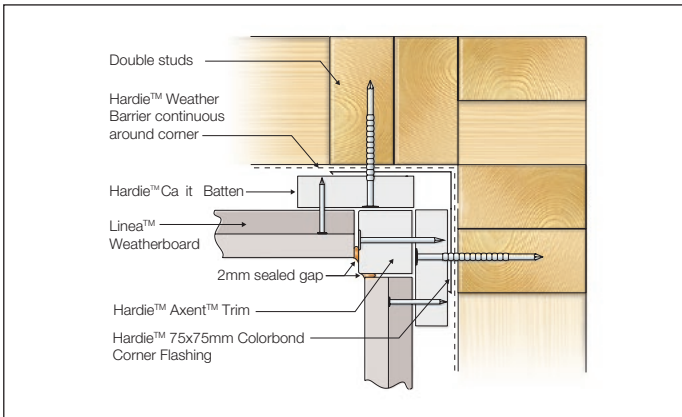

FIGURE 10 INTERNAL CORNER TRIM OPTION

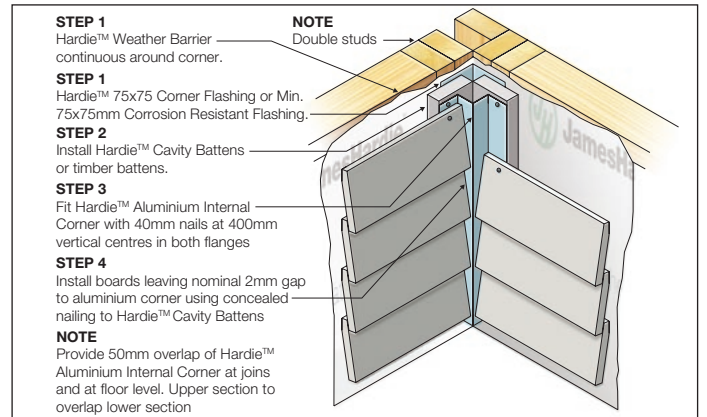

FIGURE 11 INTERNAL CORNER MOULD OPTION

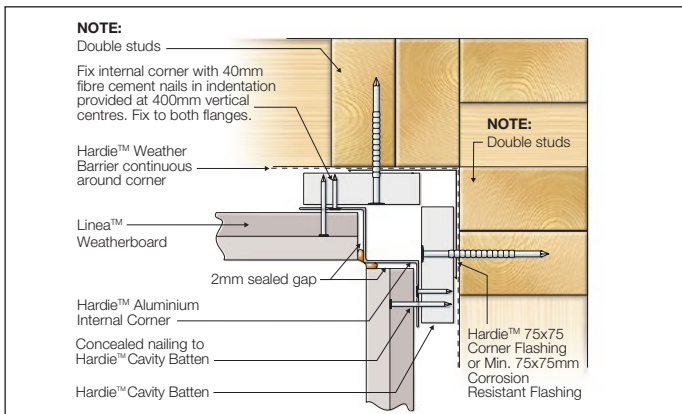

FIGURE 12 INTERNAL CORNER MOULD DETAIL

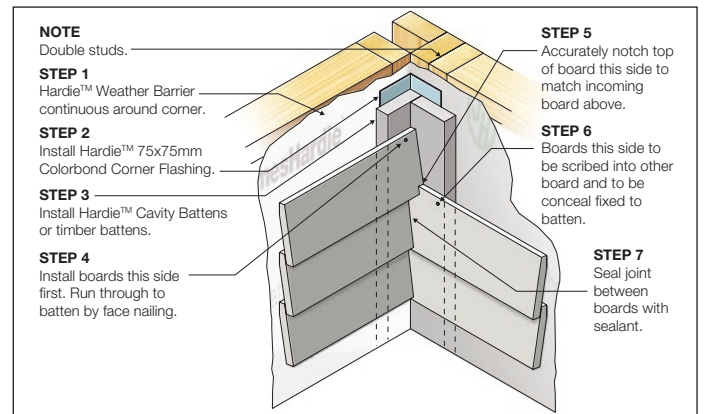

FIGURE 13 INTERNAL CORNER NOTCH & SCRIBE OPTION

## WINDOW DETAILS

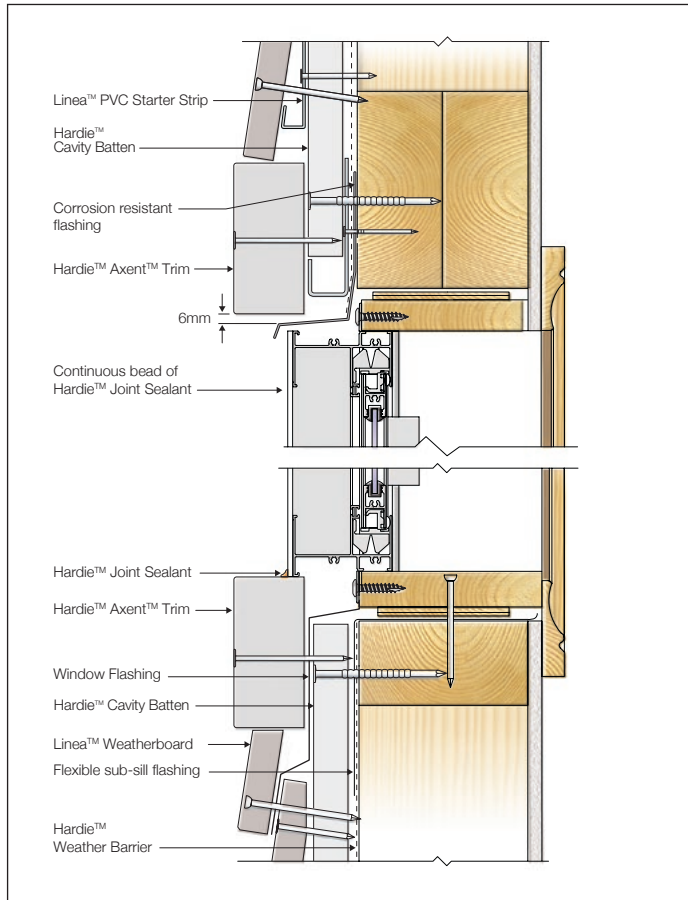

FIGURE 14 WINDOW HEAD AND SILL - TRIM OPTION

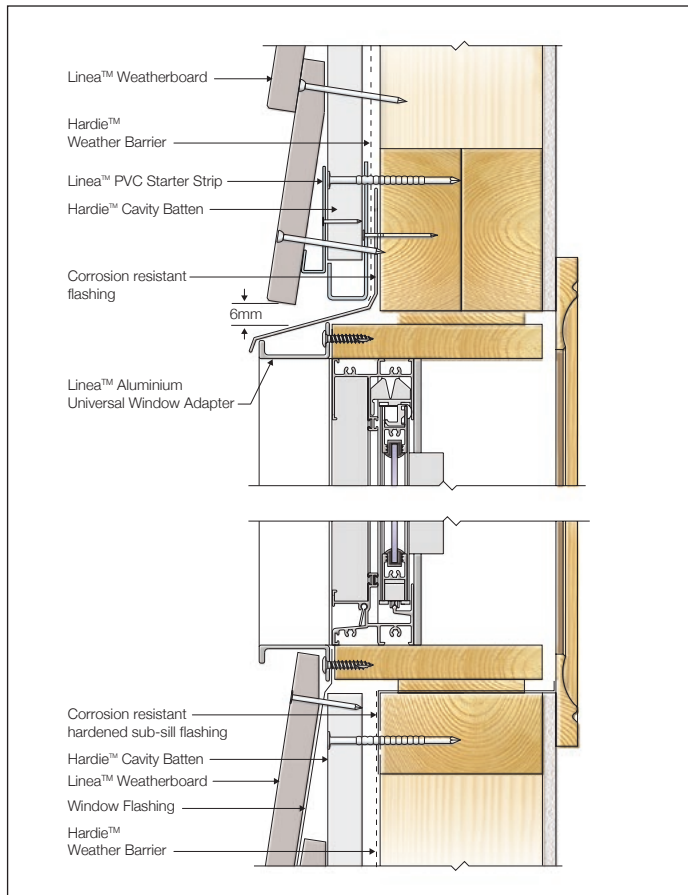

FIGURE 16 WINDOW HEAD AND SILL - LINEA™ WINDOW ADAPTER OPTION

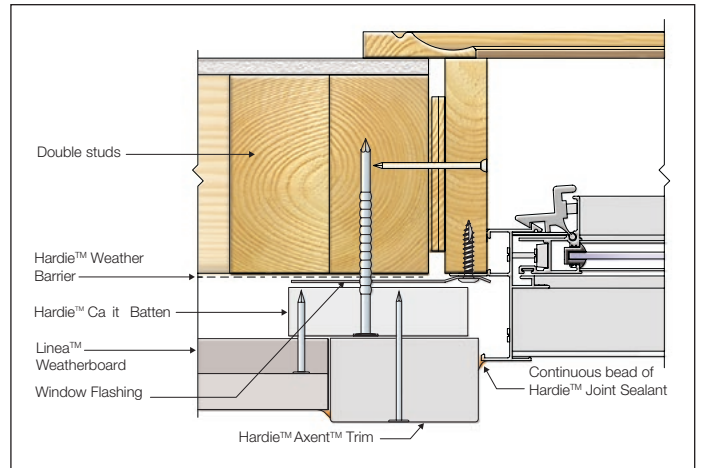

FIGURE 15 WINDOW JAMB - TRIM OPTION

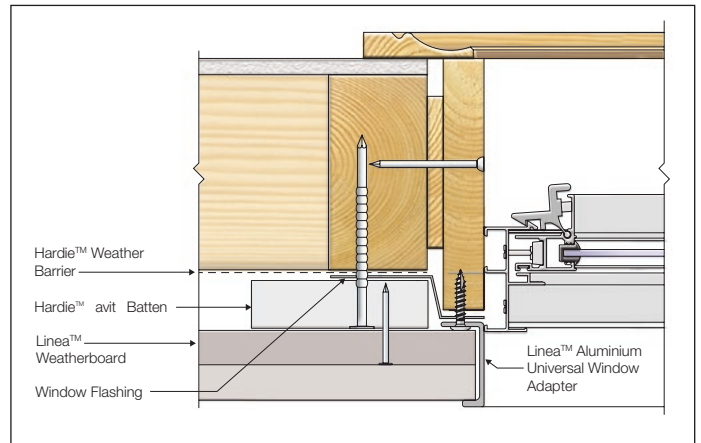

FIGURE 17 WINDOW JAMB - LINEA™ WINDOW ADAPTER OPTION

# 7 Finishes and Maintenance

## SURFACE PREPARATION

Linea™ Weatherboard is preprimed while the Hardie™ Axent™ Trim is factory presealed and would both need to be dry prior painting. Punch and fill all exposed nails a maximum of 2mm below the surface of the board.

For screws, ensure the head of the screw is nominally 2mm below the surface of the board. Fill the hole with a suitable exterior grade filler, allow to cure and sand smooth. Priming of filled and sanded patches may be required in accordance with paint manufacturer's specifications.

**NOTE:** Care must be taken not to over-sand as it can affect the finish.

### Sealants

James Hardie recommends the use of Hardie™ Joint Sealant, which is a paintable polyurethane sealant. If using an alternative sealant, it must be a quality polyurethane sealant compatible with fibre cement and the specified paint system if coated. Please refer to the manufacturer's instructions for further information.

## PAINTING

Refer to the project specification for paint requirements. Linea™ Weatherboard (pre primed) and Hardie™ Axent™ Trim (sealed) must be painted with 3 months of being installed.

James Hardie recommends the application of two coats minimum of a quality acrylic paint over the pre-primed boards in accordance with the paint manufacturer's specifications. Some environments require special coatings. Painting selection and specifications are dependent on the paint chosen. Refer to the paint manufacturer for information and details of their warranty.

## STAINING

Stains containing linseed oil are specifically designed for wood and may not be suitable for Hardie™ cladding products, primed or unprimed. Semi-transparent stains can vary in uniformity of appearance depending on method of application and conditions and will require a high level of skill and craftsmanship to achieve a uniform appearance. Clear coats have not proven durable in exterior exposure and James Hardie considers them a maintenance item that may require application of a refurbishing sealer at regular intervals. James Hardie does not warrant the appearance or durability of semi-transparent stains and clear coats.

## MAINTENANCE

The extent and nature of maintenance will depend on the geographical location and exposure of the building. As a guide, it is recommended that basic normal maintenance tasks shall include but not be limited to:

- Washing down exterior surfaces every 6-12 months\*
- Periodic inspections should be made to ensure fasteners are adequately securing the sheets to framing.
- Re-applying of exterior protective finishes\*
- Maintaining the exterior envelope and connections including joints, penetrations, flashings and sealants that may provide a means of moisture entry beyond the exterior cladding.
- Cleaning out gutters, blocked pipes and overflows as required.
- Pruning back vegetation that is close to or touching the building.
- Refer to your paint manufacturer for washing down and recoating requirements related to paint performance.

# 8 Product Information

## PRODUCT INFORMATION

### Material

The basic composition of Hardie™ fibre cement products is Portland cement, ground sand, cellulose fibre, water and proprietary additives.

Hardie™ fibre cement products are manufactured to AS/NZS 2908.2 'Cellulose-Cement Products-Flat Sheet'. These are also compliant with equivalent standard ISO 8336 'Fibre-cement flat sheets - Product specification and test methods'. For product classification refer to the relevant Physical Properties Data Sheet.

### Durability

#### Resistance to Moisture/Rotting

Linea™ Weatherboard has demonstrated resistance to permanent moisture induced deterioration (rotting) by passing the following tests in accordance with AS/NZS 2908.2:

- Water permeability (Clause 8.2.2)
- Heat rain (Clause 6.5)
- Warm water (Clause 8.2.4)
- Soak dry (Clause 8.2.5)

#### Resistance to fire

Linea™ Weatherboard is suitable where non-combustible materials are required in accordance with C2D10 and H3D2 of the National Construction Code (NCC) Vol 1 and 2 respectively.

Fibre cement products manufactured by James Hardie have been tested by CSIRO in accordance with AS/NZS 3837 and are classified as conforming to Group 1 material (highest and best result possible), with an average specific extinction area far lower than the permissible 250m<sup>2</sup>/kg, as referenced in Specification C2D11(1) of the National Construction Code (NCC).

#### Resistance to Termite Attack

Based on testing completed by CSIRO Division of Forest Products and Ensis Australia, Hardie™ fibre cement products have demonstrated resistance to termite attack.

### Alpine Regions

In regions subject to freeze/thaw conditions, all fibre cement external cladding must be installed and painted in the warmer months of the year where the temperature does not create freeze and thaw conditions or paint issues. The cladding must be painted immediately after installation. In addition, fibre cement cladding must not be in direct contact with snow and/or ice build up for extended periods, e.g. external walls in alpine regions subject to snow drifts over winter.

Furthermore, a reputable paint manufacturer must be consulted in regards to a suitable product, specifications and warranty. The paint application must not be carried out if the air temperature or the substrate temperature is outside the paint manufacturer's recommendation including the specified drying temperature range

Fibre cement products manufactured by James Hardie are tested for resistance to frost in accordance with AS/NZS 2908.2 Clause 8.2.3.



**For information and advice  
call 13 11 03 | [jameshardie.com.au](https://www.jameshardie.com.au)**

**Australia October 2023**

© 2023 James Hardie Australia Pty Ltd ABN 12 084 635 558  
™ and ® denote a trademark or registered trademark owned by James Hardie Technology Limited.  
Codemark®, Colorbond®, Hitachi, Tri-fixx® and Makita® are trademarks or registered trademarks of their respective owners and are not owned by James Hardie Technology Limited.

