



Installation Guide

Axon™ Cladding

EXTERIORS

Australia October 2023

Make sure your information is up to date.

When specifying or installing Hardie™ products, ensure that you have the current technical information and guides. If in doubt, or you need more information, visit jameshardie.com.au or Contact James Hardie on 13 11 03.

CONTENTS

1	INTRODUCTION	2
	Scope	2
2	SAFE WORKING PRACTICES	3
	Warning	3
	Recommended safe working practices	3
	Storage and handling	3
3	DESIGN CONSIDERATIONS	3
	Framing	4
	Fasteners	4
4	PRODUCTS AND ACCESSORY DETAILS	5
	Components	5
	Fasteners, Battens and Tapes	6
5	CLADDING INSTALLATION - DIRECT FIX	7
6	CLADDING INSTALLATION - CAVITY FIX	8
7	INSTALLATION DETAILS - DIRECT FIX	9
	Junction Details	9
	External Corner Details	9
	Internal Corner Details	10
	Window Details	10
7	INSTALLATION DETAILS - CAVITY FIX	11
	Junction Details	11
	External Corner Details	11
	Internal Corner Details	12
	Window Details	12
9	FINISHES AND MAINTENANCE	13
	Finishing	13
	Painting	13
	Maintenance	13
10	PRODUCT INFORMATION	13

Made in Australia

SCOPE

This guide covers the use of the Axon™ Cladding in a residential facade application over a seasoned timber wall frame or a light-gauge steel frame.

CODEMARK CERTIFICATION

The CodeMark Certification Scheme is a voluntary third-party building product certification scheme that authorises the use of new and innovative products in specified circumstances in order to facilitate compliance with Volume 1 and 2 of the NCC.

Axon™ Cladding has been certified under the CodeMark scheme (Certificate Number CM40222) and available at www.jameshardie.com.au. This certificate can be provided to building certifiers and other regulatory authorities to facilitate the assessment of the product compliance or used to verify the suitability of the product for certain applications.



Axon™ Cladding

Bring drama and detail to your walls with vertical lines.

1 Introduction

Introduce drama and detail to your walls with the clean vertical lines of Axon™ Cladding. Incorporating the beauty and fine detail of painted vertical joint timber, but without time-consuming board construction or durability hassles, Axon™ Cladding is a range of vertically grooved panels with the detail of vertical joint timber.



Featuring a stepped shiplap joint on the long edges for easy installation, it can be gun nailed and cut cleanly with a circular saw using a dust-reducing fibre cement blade.

The ideal option for contemporary upper storey and ground floor extensions and suited to modern and beachy building styles, vertical lines make an impact with line and form and bring variety and textural interest to external walls.

IMPORTANT NOTES

1. Failure to install, finish or maintain this product in accordance with applicable building codes, regulations, standards and James Hardie's written application instructions may lead to personal injury, affect system performance, violate local building codes, and void Hardie™ product warranty.
2. All warranties, conditions, liabilities (direct, indirect or consequential) and obligations whether arising in contract, tort or otherwise other than those specified in James Hardie's product warranty are excluded to the fullest extent allowed by law. For Hardie™ product warranty information and disclaimers about the information in this guide, visit www.jameshardie.com.au.
3. The builder must ensure the product meets aesthetic requirements before installation. James Hardie will not be responsible for rectifying aesthetic surface variations following installation.

2 Safe Working Practices 3 Design Considerations

WARNING - DO NOT BREATHE DUST AND CUT ONLY IN WELL VENTILATED AREA

Hardie™ fibre cement products contain sand, a source of respirable crystalline silica. **May cause cancer if dust from product is inhaled. Causes damage to lungs and respiratory system through prolonged or repeated inhalation of dust from product.** Intact fibre cement products are not expected to result in any adverse toxic effects. The hazard associated with fibre cement arises from the respirable crystalline silica present in dust generated by activities such as cutting, rebating, drilling, routing, sawing, crushing, or otherwise abrading fibre cement, and when cleaning up, disposing of or moving dust. When doing any of these activities in a manner that generates dust, follow James Hardie's instructions and best practices to reduce or limit the release of dust, warn others in the area and consider rotating personnel across the cutting task to further limit respirable silica exposure. If using a dust mask or respirator, use an AS/NZS1716 P1 filter and refer to Australian/New Zealand Standard 1715:2009 Selection, Use and Maintenance of Respiratory Protective Equipment for more extensive guidance and more options for selecting respirators for workplaces. For further information, refer to our installation instructions and Safety Data Sheets available at www.jameshardie.com.au. FAILURE TO ADHERE TO OUR WARNINGS, SAFETY DATA SHEETS, AND INSTALLATION INSTRUCTIONS MAY LEAD TO SERIOUS PERSONAL INJURY OR DEATH.

James Hardie Recommended Safe Working Practices

CUTTING OUTDOORS

1. Position cutting station so wind will blow dust away from the user or others in working area.
2. Warn others in the area to avoid dust.
3. Consider rotating personnel across cutting tasks to further limit respirable silica exposures.
4. Use one of the following methods based on the required cutting rate:
 - Best** ▪ Villaboard™ Knife ▪ Hand guillotine ▪ Fibreshear
 - Better** ▪ Position the cutting station in a well-ventilated area. Use a dust reducing circular saw equipped with Hardie™ Blade Saw Blade or comparable fibre cement blade and well maintained M-class vacuum or higher with appropriate filter for capturing fine (respirable) dust. Wear a properly-fitted, approved dust mask or respirator (minimum P1).

CUTTING INDOORS

- Cut only using Villaboard™ Knife, hand guillotine or fibreshears (manual, electric or pneumatic).
- Position cutting station in a well-ventilated area.

DRILLING/OTHER MACHINING

When drilling or machining you should always wear a P1 dust mask and warn others in the immediate area.

IMPORTANT NOTES

1. For maximum protection (lowest respirable dust production) James Hardie recommends always using best practice cutting methods where feasible.
2. NEVER use a power saw indoors or in a poorly ventilated area.
3. ALWAYS use a dust reducing circular saw equipped with a sawblade specifically designed to minimise dust creation when cutting fibre cement - preferably a sawblade that carries the Hardie™ Blade logo or one with at least equivalent performance - connected to a M class or higher vacuum.
4. NEVER dry sweep - Use wet suppression, or an M class vacuum or higher with appropriate filter.
5. NEVER use grinders.
6. ALWAYS follow tool manufacturers' safety recommendations.
7. ALWAYS wear a properly fitted, approved dust mask, P1 or higher

DUST MASKS AND RESPIRATORS

As a minimum, an AS/NZS1716 P1 respirator must be used when doing any activity that may create dust. For more extensive guidance and options for selecting respirators for workplaces please refer to Australian/New Zealand Standard 1715:2009 "Selection, Use and Maintenance of Respiratory Protective Equipment". P1 respirators should be used in conjunction with the above cutting practices to minimise dust exposure. For further information, refer to Safety Data Sheet (SDS) available at www.jameshardie.com.au. If concern still exists about exposure levels or you do not comply with the above practices, you should always consult a qualified industrial hygienist or contact James Hardie for further information.

STORAGE AND HANDLING

To avoid damage, all Hardie™ building products should be stored with edges and corners of the product protected from chipping. Hardie™ fibre cement products must be installed in a dry state and protected from weather during transport and storage. The product must be laid flat under cover on a smooth level surface clear of the ground to avoid exposure to water, moisture, etc.

All design and construction must comply with the appropriate requirements of the current National Construction Code (NCC) and other applicable regulations and standards.

Responsibility

The specifier or other party responsible for the project must ensure that the details in this specification are appropriate for the intended application and that additional detailing is performed for specific design or any areas that fall outside the scope of this specification.

Slab and Footings

The slab and footings on which the building is situated must comply with AS 2870 'Residential slabs and footings – Construction' and the requirements of the NCC.

Ground Clearances

Install Axon™ Cladding with a minimum 150mm clearance to the earth on the exterior of the building or in accordance with local building codes if greater than 150mm is required. Maintain a minimum 50mm clearance between the external cladding and roofs, decks, paths, steps and driveways.

Adjacent finished grade must slope away from the building in accordance with local building codes, typically a minimum slope of 50mm over the first metre.

Do not install external cladding such that it may remain in contact with standing water.

NOTE

Greater clearance may be required in order to comply with termite protection provisions, see below for more information.

Termite Protection

The NCC specifies the requirements for termite barriers. Where the exposed slab edge is used as part of the termite barrier system, a minimum of 75mm of the exposed slab edge must be visible to permit ready detection of termite entry.

Structural Bracing

Axon™ Cladding can be installed to provide wall bracing against lateral forces due to wind. For further information, Contact James Hardie on 13 11 03.

Fire Rated Walls

Axon™ Cladding can be used as part of a fire rated wall when constructed with additional fire rated linings as specified in Hardie™ Fire and Acoustically Rated Walls Application Guide and Technical Specification or the Hardie™ Smart Boundary Wall System Design Guide. The length of fasteners must be increased for the additional linings.

Moisture Management

It is the responsibility of designer or specifier to identify moisture related risks associated with any particular building design. Wall construction design must effectively manage moisture, accounting for both the interior and exterior environments of the building, particularly in buildings that have a higher risk of wind driven rain penetration or that are artificially heated or cooled.

In addition, all wall openings, penetrations, junctions, connections, window sills, heads and jambs must incorporate appropriate flashing and waterproofing. Materials, components and their installation that are used to manage moisture in framed wall construction must, at a minimum, comply with the requirements of relevant standards and the NCC.

Weather Barrier

A suitable water control membrane must be installed under Hardie™ cladding in accordance with the AS/NZS 4200.2 'Pliable building membranes and underlays – Installation' and NCC requirements.

James Hardie has tested and certified the use of RAB™ Board for climate zones - 2-8 within Australia. Hardie™ Weather Barrier is a Class 4 vapour permeable membrane that delivers a triple-shield of protection to help against external weather penetration, internal condensation management and external heat penetration through its safe-glare reflective layer.

If using an alternate product in lieu of Hardie™ Weather Barrier or RAB™ Board or the project is located in a hot, humid area (Climate Zone 1), the designer must ensure that the product is fit for purpose and it has the following classification in accordance with AS/NZS 4200.1:2017 'Pliable building membranes and underlays – Materials':

TABLE 1

Weather Barrier Classification		
Climate Zone	Water Control Classification	Vapour Control Category
2-8	Water Barrier	Vapour Permeable (Class 3 or 4)
1		Vapour Barrier (Class 1 or 2)

Soft compressible insulation installed between the front of the wall studs and directly behind the external cladding can cause installation issues and is thus not recommended.

Flashing

All wall openings, penetrations, intersections, connections, window sills, heads and jambs must be flashed prior to cladding installation.

FRAMING

General

Axon™ Cladding can be installed vertically either directly fixed to frame or installed to vertically oriented Hardie™ Cavity Batten to provide a vented cavity, this can be done over either timber or steel frames. The general framing requirements for installation are given in Table 2.

Maximum stud, Hardie™ Cavity Batten and fastener spacing for Axon™ Cladding for wind load classifications of AS 4055 'Wind Loads for Housing' are given in Table 3.

FASTENERS

General

All nails must be driven flush. Screws may be driven flush or countersunk 1.5mm and filled over flush with Megapoxy P1. For more information and advice, Contact James Hardie on 13 11 03.

Fastener Durability (Including Coastal Areas)

Fasteners must have the appropriate level of durability and be fully compatible with all other materials required for the intended project. In areas within 1km of a coastal area, areas subject to salt spray and other corrosive environments, class 4 fasteners must be used.

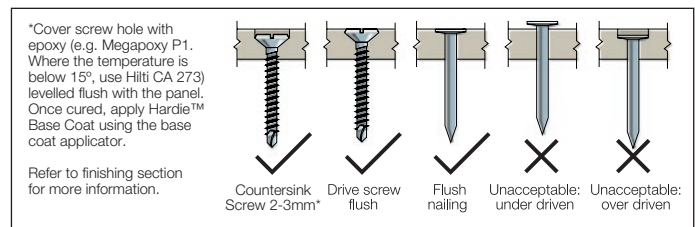

NAIL FASTENER DEPTH

TABLE 2

General Framing Requirements				
Type	Timber		Steel	
Design	Use of timber framing must be in accordance with AS 1684 and the framing manufacturer's specifications		Use of steel framing must be in accordance with NASH standard for Residential and Low-Rise Steel Framing Part 1: Design Criteria and the framing manufacturer's specifications.	
Durability	Timber used for house construction must have the level of durability appropriate for the relevant climate and expected service life. Reference AS 1684.2 'Residential timber-framed construction'.		The steel framing must have the appropriate level of durability required to prevent corrosion, particularly in coastal areas.	
Tolerances	Ensure frame is square and work from a central datum line. A suggested maximum tolerance of between 3mm and 4mm in any 3000mm length of frame will give best results.			
Thermal Break Requirement	Not required.		For steel frames, the NCC Sections J3D6 and 13.2.5 Volumes 1 and 2 respectively, state for both residential and commercial buildings a thermal break with an R 0.2m ² K/W must be installed behind external cladding where the cladding and internal lining make direct contact with the same steel frame. Alternatively, vented cavity installation using minimum 70x350mm timber battens or off-stud Hardie™ Cavity Battens can be used in these applications.	
Framing specifications				
	Direct Fix	Cavity Fix	Direct Fix	Cavity Fix
BMT	NA		From 0.55 to 1.6mm.	From 0.55 to 1.6mm.
Min. Stud Width	45mm at sheet edges. 35mm at intermediates.	35mm	45mm at sheet edges. 42mm at intermediates	Min. 32mm
Min. Stud Depth	70mm	70mm	64mm	64mm
Max. Nogging spacing	1350mm	1350mm for on stud batten fixing. 800mm for off stud batten fixing.	1350mm when battens are fixed on stud or 800mm when fixed off stud	800mm off stud batten fixing only.
Battens	N/A	Hardie™ Cavity Battens or minimum MGP10 70 x 35mm timber battens	Hardie™ Cavity Battens or minimum MGP10 70 x 35mm timber battens	Hardie™ Cavity Battens or minimum MGP10 70 x 35mm timber battens

TABLE 3

Maximum Stud, Hardie™ Cavity Batten or timber batten & fastener spacing for Axon™ Cladding in AS4055 Wind Classification							
Wind Classification	Stud and cavity batten or timber batten spacing	Only required for cavity fix				Sheet Fastener Spacing (Except Brad Nails)	Sheet Fastener Spacing (Brad Nails)
		Can be fixed off stud?		Batten fastener spacings			
		Hardie™ Cavity Battens	Timber Battens	Hardie™ Cavity Battens	Timber Battens		
N1, N2, N3/C1	600	Yes	Yes	300	300	200	125
N4/C2	600	No	No	200	200	200	125*
N5/C3	450	No	No	200		150	
N6/C4	300	No	No	200		125	

NOTE - When using brad nails:
 ■ Refer to the accessories page for brad nails options.

NOTE - Off-stud cavity installation:
 ■ When fixing Hardie™ Cavity Battens or timber battens offstud, noggings must be spaced based on the maximum batten span as described on Table 4.

* Only suitable when fixing to Hardie™ Cavity Battens or timber battens.
 Not suitable for direct fix to frame.

TABLE 4

Maximum span for Hardie™ Cavity Batten or timber batten			
Batten	Dimensions (mm)	Max. Span (mm)	
		Timber Frame	Steel Frame
Hardie™ Cavity Batten	70 x 19	800	800*
Timber Battens	70 x 35	1350*	800*

NOTES:



*Requires using two nails per fixing point when installing the battens off-stud. Refer to the Product and Accessories Details on page 7 for fastener and fixing requirements.

A continuous bead of Hardie™ Joint Sealant is required between the vertical battens and the back of the cladding in all cases.

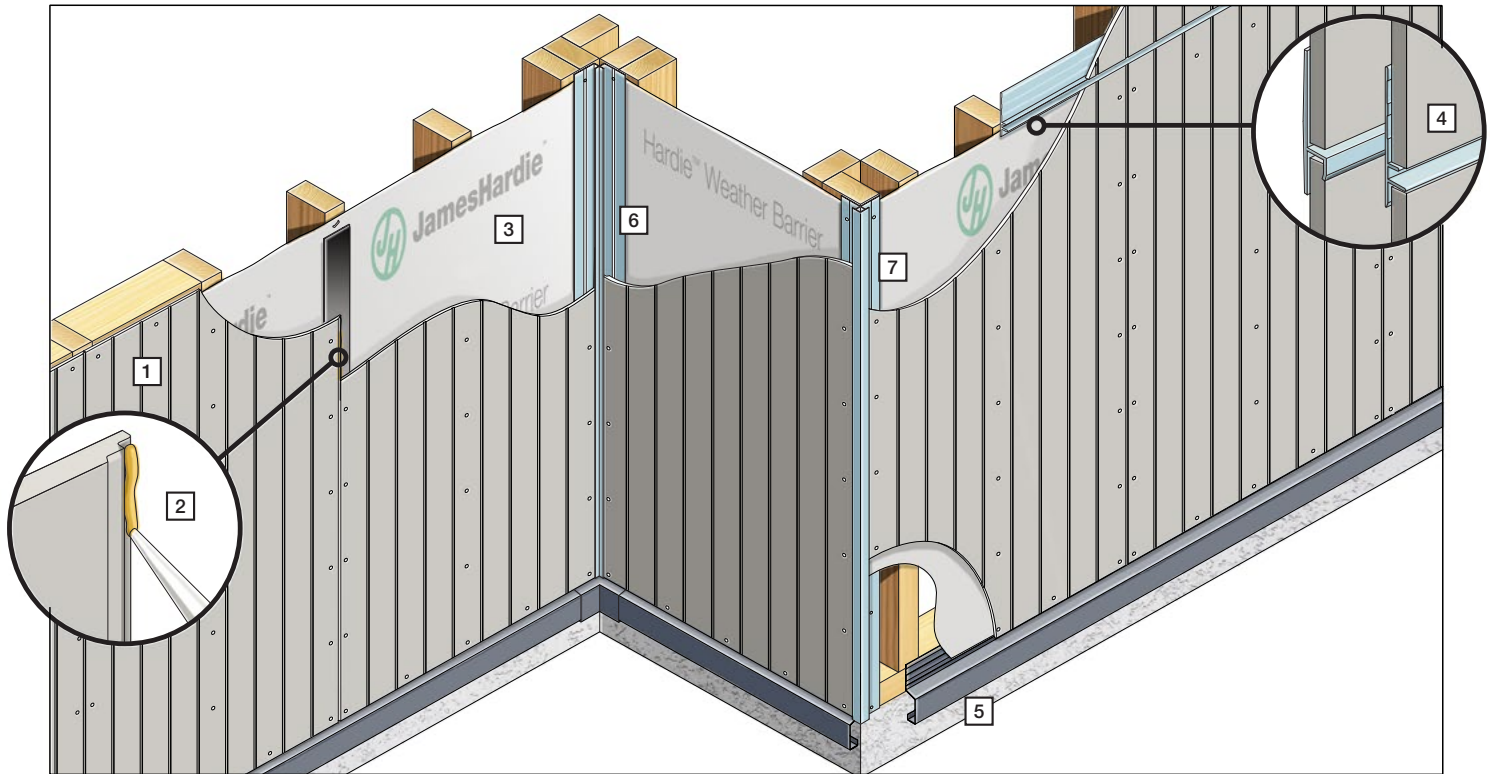
4 Products and Accessory Details

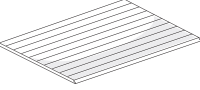

COMPONENTS

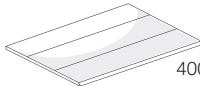
1 Axon™ Cladding Range (9mm thick)						
Axon™ Cladding	Description	Product Code	Length (mm)	Width (mm)	Weight per Sheet (kg)	Pack Size
 Axon™ Cladding 133 Smooth Pre-primed with vertical grooves. There is a ship lap edge joint along the two long edges and square edges along the short edges. The grooves are nominally 2mm deep and 10mm wide. Sheet weighs approximately 12kg/m ² in equilibrium.		403931	2450	1200	38	30
		403932	2750	1200	43	30
		403933	3000	1200	47	30
		404979	3600	1200	56	30
 Axon™ Cladding 133 Grained Grooves at 133mm centres		404512	3000	1200	47	30
 Axon™ Cladding 400 Smooth Grooves at 400mm centres		404417	2450	1200	38	30
		404418	2750	1200	43	30
		404419	3000	1200	47	30

2 Hardie™ Joint Sealant



General purpose polyurthane exterior slab edge solution. Pack Size: 20/Box. Product Code: 305534 300ml Cartridge Product Code: 305672 600ml Sausage Coverage: 2.67m/100ml (5mm dia bead)

3 Hardie™ Weather Barrier



Water barrier and vapour permeable membrane. Unit size: 2.75 x 30m. Pack Size: 1 Each. Product Code: 305664 Coverage: 82.5m² per roll

3 RAB™ Board



Airtight, weatherproof, vapour permeable and non-combustible rigid 6mm fibre-cement sheathing. 40 per pack 1200 x 2450mm Prod Code: 402980 1200 x 2750mm Prod Code: 405131 1200 x 3000mm Prod Code: 402981

Horizontal Flashing Options

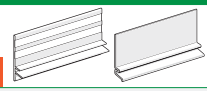
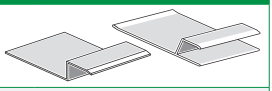
4 Hardie™ 9mm Aluminium Recessed Horizontal Jointer	4 Hardie™ Horizontal h Flashing
 <p>NEW</p> <p>A recessed horizontal jointer that creates a 6mm horizontal shadow line. Product Code: 306190 Connector Product Code: 306191 Coverage: Length of horizontal joints / 3000mm</p>	 <p>Aluminium extrusion used along horizontal control joints. Product Codes: h flashing 3000mm (5/pack) 305613 h flashing jointer (10/pack) 305614 Coverage: Length of horizontal joints / 3000mm</p>

5 Hardie™ Edge Trim



Powder coated aluminium architectural slab edge solution. Product Codes: Hardie™ Edge Trim (4/pack) 305911 Base Trim Jointer (12/pack) 305912 Internal Corner (4/pack) 305913 External Corner (4/pack) 305914

6 Hardie™ 9mm Internal Corner

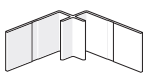

Aluminium extrusion to be used in internal corners. 3000mm long. Pack Size: 5 Product Code: 305520 Coverage: Height of wall x no. of internal corners / 3000mm

7 Hardie™ 9mm External Square Corner



Aluminium extrusion to be used in external corners. 3000mm long. Pack Size: 5 Product Code: 306100 Coverage: Height of wall x no. of external corners / 3000mm

Alternative Corner Options

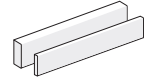
Hardie™ Corner Flashing	Hardie™ Axent™ Trim
 <p>A corner flashing, manufactured using COLORBOND® steel, used behind cladding at internal and external corners. 75 x 75mm. 3000mm long. Pack Size: 5. Product Code: 305564 Coverage: Height of clad walls x no. of corners / 3000mm</p>	 <p>Factory sealed material composite trim used for box corners and as decorative trim around the windows and doors. The front face of the trims are chamfered to improve their aesthetic appeal. For internal corners: 45 X 38mm 3000mm long. Product Code: 405261 For external corners: 45 X 19mm 3000mm long. Product Code: 405260</p>

4 Products and Accessory Details cont.

Axon™ Cladding can be fixed either to timber or steel frames, which can be done directly or over Hardie™ Cavity Battens or 70 X 35mm timber battens. Depending on the fixing method and substructure, there will be different components required, these are:

OPTION 1: DIRECT FIX - TIMBER FRAME

	<p>8 Hardie™ Foam Back Sealing Tape</p> <p>Installed under sheet vertical joints to improve water tightness. 50mm wide 25mtr long roll. Pack Size: Each Product Code: 304560</p>	<p>9 Fibre Cement Nail*</p> <p>2.8 x 40mm corrosion resistant fibre cement nail for fixing Axon™ Cladding onto timber stud frame. Not supplied by James Hardie.</p>	<p>Gun Nail*</p> <p>2.8 x 40mm minimum class 3 nail with a minimum 6mm head diameter to be used with gun nails. Not supplied by James Hardie.</p>	<p>ND 50mm Stainless Steel Brad Nail*</p> <p>14 gauge x 50mm ND 304 stainless steel nail for fixing Axon™ Cladding to timber framing. Not supplied by James Hardie.</p>
--	---	--	--	--

OPTION 2: DIRECT FIX - STEEL FRAME

	<p>10 Hardie™ Break Thermal Strip</p> <p>Refer to the Hardie™ Break Thermal Strip install guide.</p> <p>NCC requirement used behind external cladding when fixed directly to steel frame. Size: 43 x 12 x 2750mm. 45 per pack. Product Code: 305612</p>	<p>11 Hardie™ Drive Screw 41mm long*</p> <p>A class 3 self-tapping wing-tipped screw for fastening to 0.5mm to 1.6mm BMT light gauge steel frames. 1000 per box. Product Codes: 305984 (loose) 305982 (collated)</p>
--	--	---

OPTION 3: CAVITY FIX - TIMBER FRAME

	<p>12 Battens</p> <p>Fibre cement batten used to fix external cladding to steel or timber frame. Pack Size: 96 Size: 70 x 19 x 3000mm. Product Code: 405307</p>	<p>13 Nails to fix batten to frame*</p> <p>2.8 x 65mm long ring shank nail or 75 x 2.8mm D or round head galvanised smooth shank nail. Not supplied by James Hardie.</p>	<p>14 Brad Nails* to fix cladding to battens</p> <p>25mm DA or C 16-gauge 304 stainless steel brad nails. Not supplied by James Hardie. Apply continuous Hardie™ Joint Sealant between the batten and cladding.</p>	<p>14 Fibre Cement Nails* to fix cladding to battens</p> <p>Only required in high wind areas. 2.8 x 40mm corrosion resistant fibre cement nail. Not supplied by James Hardie.</p>
--	--	---	--	---



	<p>When using 70 x 35mm Timber Battens</p> <p>Timber batten used to fix external cladding to steel or timber frame. Not supplied by James Hardie.</p>	<p>Two 75 x 3.06mm D Head Class 3 nails per fixing.</p>	<p>25mm DA or C 16-gauge 304 stainless steel brad nails. Not supplied by James Hardie. Apply continuous Hardie™ Joint Sealant between the batten and cladding.</p>
--	--	---	--

OPTION 4: CAVITY FIX - STEEL FRAME

	<p>12 Battens</p> <p>Fibre cement batten used to fix external cladding to steel or timber frame. Pack Size: 96 Size: 70 x 19 x 3000mm. Product Code: 405307</p>	<p>15 Screws to fix batten to frame*</p> <p>Two Hardie™ Drive Screws - Class 3 self-tapping wing-tipped screw for fastening to 0.5mm to 1.6mm BMT light gauge steel frames. 1000 per box. Product Codes: 305984 (loose) 305982 (collated).</p>	<p>14 Brad Nails* to fix cladding to battens</p> <p>25mm DA or C 16-gauge 304 stainless steel brad nails. Not supplied by James Hardie. Apply continuous Hardie™ Joint Sealant between the batten and cladding.</p>	<p>14 Fibre Cement Nails* to fix cladding to battens</p> <p>Only required in high wind areas. 2.8 x 40mm corrosion resistant fibre cement nail. Not supplied by James Hardie.</p>
--	--	---	--	---

	<p>When using 70 x 35mm Timber Battens</p> <p>Timber batten used to fix external cladding to steel or timber frame. Not supplied by James Hardie.</p>	<p>Two 10-24 x 65mm Class 3 self-drilling CSK-Head screws per fixing.</p>	<p>25mm DA or C 16-gauge 304 stainless steel brad nails. Not supplied by James Hardie. Apply continuous Hardie™ Joint Sealant between the batten and cladding.</p>
--	--	---	--

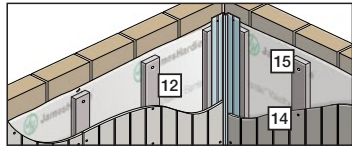
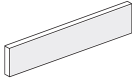
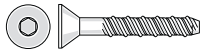
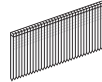
OPTION 4: CAVITY FIX - BRICK WALL

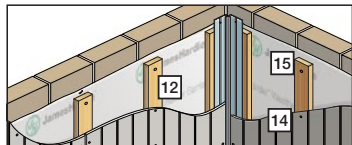
	<p>12 Battens</p> 	<p>15 Screws to fix battens to brick wall</p> 	<p>14 Brad Nails* to fix cladding to battens</p> 	<p>14 Fibre Cement Nails* to fix cladding to battens</p> 
<p>When using Hardie™ Cavity Battens</p> <p>Fibre cement batten used to fix external cladding to steel or timber frame. Pack Size: 96 Size: 70 x 19 x 3000mm. Product Code: 405307</p>	<p>DeWalt 6mm Blue-Tip 2 Screw-Bolt™ with a minimum embedment of 40mm.† Not supplied by James Hardie.</p>	<p>25mm DA or C 16-gauge 304 stainless steel brad nails. Not supplied by James Hardie. Apply continuous Hardie™ Joint Sealant between the batten and cladding.</p>	<p>Only required in high wind areas. 2.8 x 30mm corrosion resistant fibre cement nail. Not supplied by James Hardie.</p>	
	<p>When using 70 x 35mm Timber Battens</p> <p>Timber batten used to fix external cladding to steel or timber frame. Not supplied by James Hardie.</p>	<p>DeWalt 6mm Blue-Tip 2 Screw-Bolt™ with a minimum embedment of 40mm.† Not supplied by James Hardie.</p>	<p>25mm DA or C 16-gauge 304 stainless steel brad nails. Not supplied by James Hardie. Apply continuous Hardie™ Joint Sealant between the batten and cladding.</p>	

All dimensions and masses are approximate and subject to manufacture tolerances.

* In coastal areas and other corrosive environments class 4 fasteners must be used. All other areas require minimum class 3.

† A structural engineer must determine whether the substrate is adequate to hold the proposed anchors, Hardie™ Cavity Batten or Timber Batten and the Hardie™ Cladding Loads.
The anchor bolt connecting the battens to the concrete or masonry wall shall have a working load capacity of 0.7kN, equivalent to an Ultimate Limit State phi-R capacity of 1.05kN.

Accessories

<p>Epoxy Flush Sealing (2 Part)</p>

<p>Countersunk head screws are flush filled using Megapoxy® P1.</p>

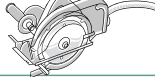
Tools

<p>Hardie™ Blade Saw Blade 185mm Diameter</p>	<p>Dust-Reducing Saw with M class or higher vacuum Extraction</p>
	
<p>Poly-diamond blade for Hardie™ fibre cement. Pack Size: 1 each. Product Code: 300660</p>	<p>Dust reducing saw with a Hardie™ Blade saw blade. Makita 5057KB / Hitachi C7YA.</p>

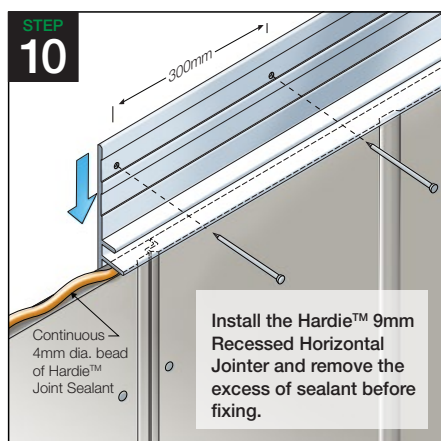
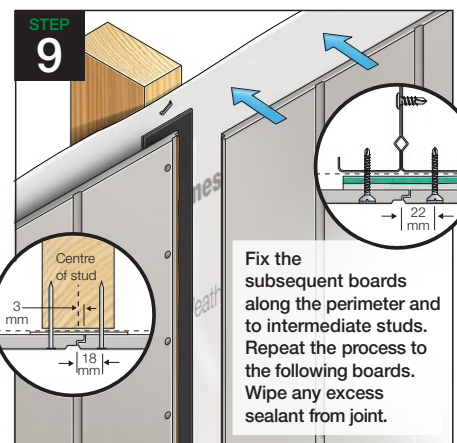
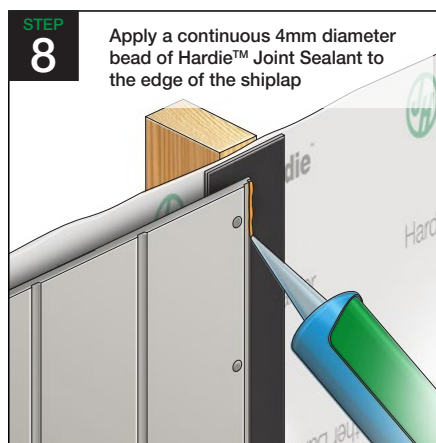
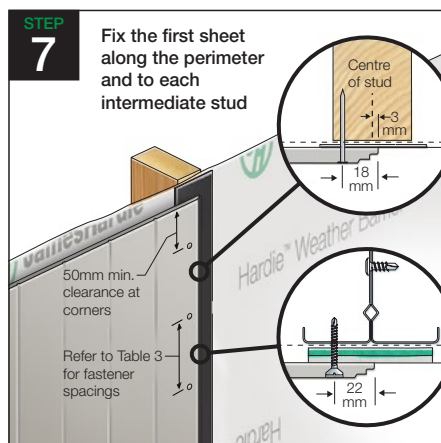
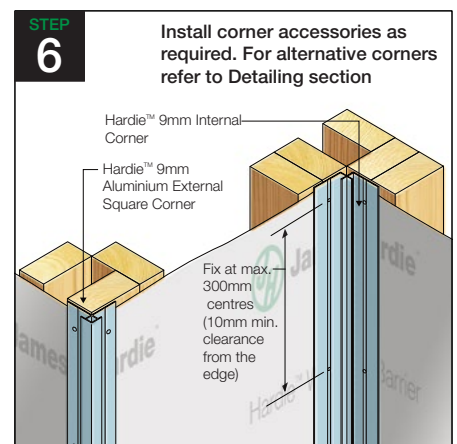
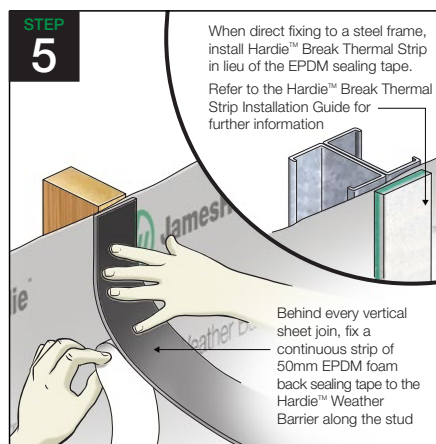
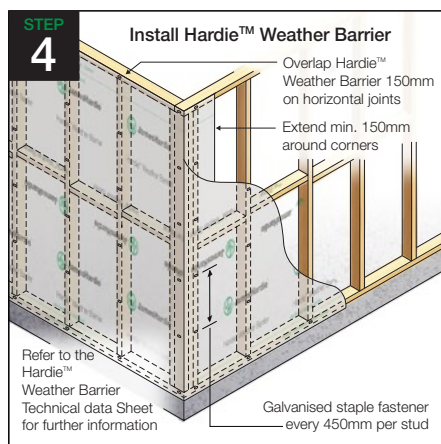
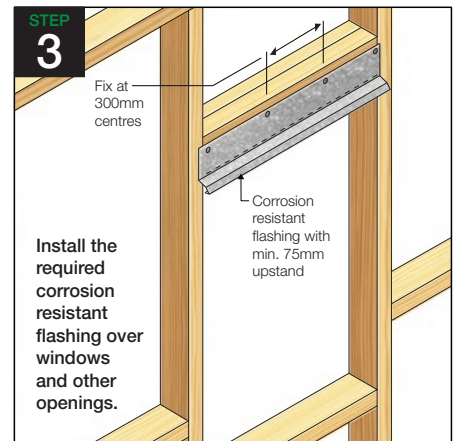
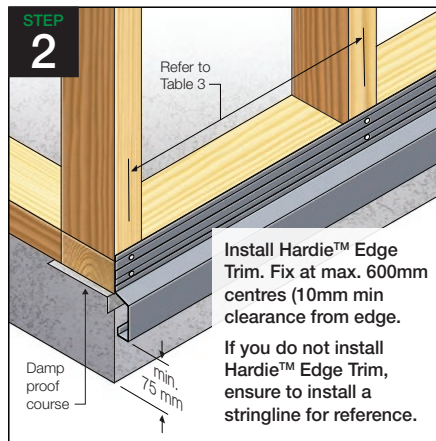
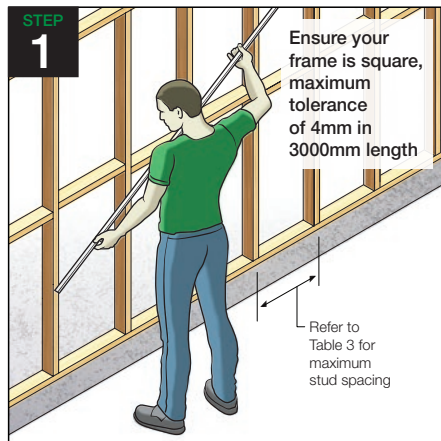
5 Cladding Installation Process* - Direct Fix



*This is an overview of the installation process only. It is not a substitute for reviewing this document in its entirety prior to installation.

6 Cladding Installation Process* - Cavity Fix

STEP 1 Ensure your frame is square, maximum tolerance of 4mm in 3000mm length

Max. 800mm centres when fixing cavity battens off-stud
Refer to Table 3 for maximum stud spacing

STEP 2 Install the required corrosion resistant flashing over windows and other openings.

Fix at 300mm centres
Corrosion resistant flashing with min. 75mm upstand

STEP 3 Install Hardie™ Weather Barrier

Overlap Hardie™ Weather Barrier 150mm on horizontal joints
Extend min. 150mm around corners
Galvanised staple fastener every 450mm per stud
Refer to the Hardie™ Weather Barrier Technical data Sheet for further information

STEP 4 Install the Hardie™ PVC Cavity Vent Strip

Fix at 600mm centres maximum, with 10mm edge clearance.
min. 150mm
Hardie™ PVC Cavity Vent Strip mitred at corners and kept clear of debris. Do not insert Hardie™ Cavity Batten into the vent strip.
10mm

STEP 5 Install Hardie™ Cavity Battens or timber battens (must be fixed off-stud in steel frames)

45° cut
Hardie™ Joint Sealant
50mm
50mm
Hardie™ Cavity Batten
20mm min.
Refer to Table 3 for fastener spacing

STEP 6 Install corner accessories as required. For alternative corners refer to Detailing section

Hardie™ 9mm Internal Corner
Hardie™ Cavity Batten
Hardie™ 9mm Aluminium External Square Corner
Fix at max. 300mm centres (10mm min. clearance from the edge)

STEP 7 Fix the first sheet along the perimeter and to each intermediate stud

50mm min. clearance at corners
Refer to Table 3 for fastener spacings
18mm

STEP 8 Apply a continuous 4mm diameter bead of Hardie™ Joint Sealant to the edge of the shiplap

Bead of Hardie™ Joint Sealant

STEP 9 Fix the subsequent boards along the perimeter and to intermediate studs. Repeat the process to the following boards. Wipe any excess sealant from joint.

18mm

STEP 10 Install the Hardie™ 9mm Recessed Horizontal Jointer and remove the excess of sealant before fixing.

300mm
Continuous 4mm dia. bead of Hardie™ Joint Sealant

STEP 11 Patch and repair the surface if required. Ensure to refer to Finishing section on page 13 for full information.

STEP 12 Paint the wall within 3 months of being fixed or within 7 days if located within 1km of a coastal area or corrosive environment

Refer to Finishing section on page 13 for more information.

*This is an overview of the installation process only. It is not a substitute for reviewing this document in its entirety prior to installation.

7 Construction Details - Direct Fix

JUNCTION DETAILS

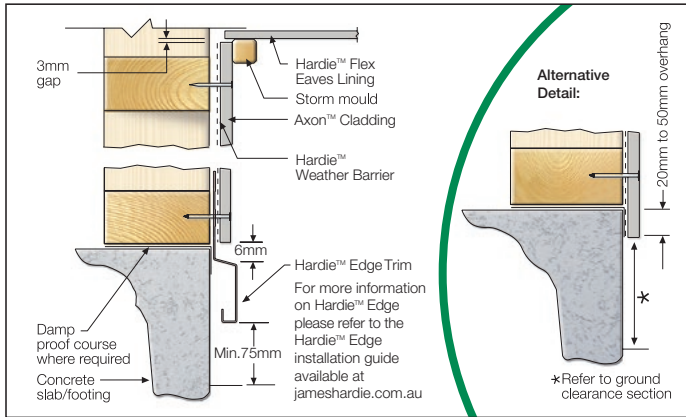

FIGURE 1 SLAB/EAVE JUNCTION DETAIL

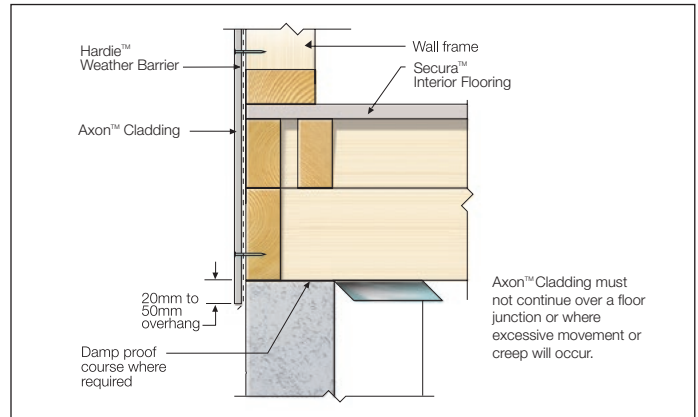

FIGURE 2 LOWER FLOOR JUNCTION

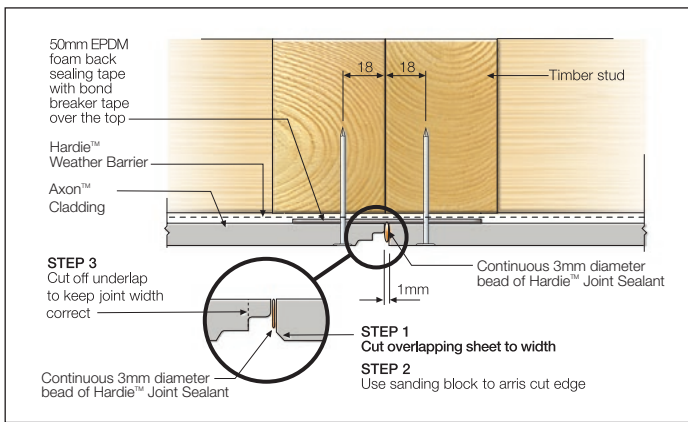

FIGURE 3 VERTICAL BUTT JOINT

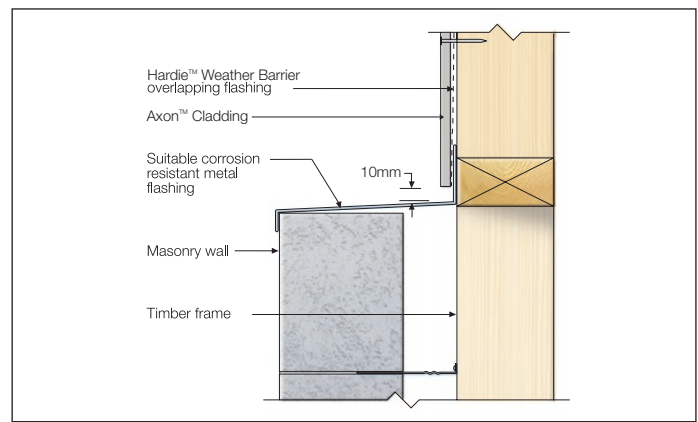

FIGURE 4 HORIZONTAL JUNCTION

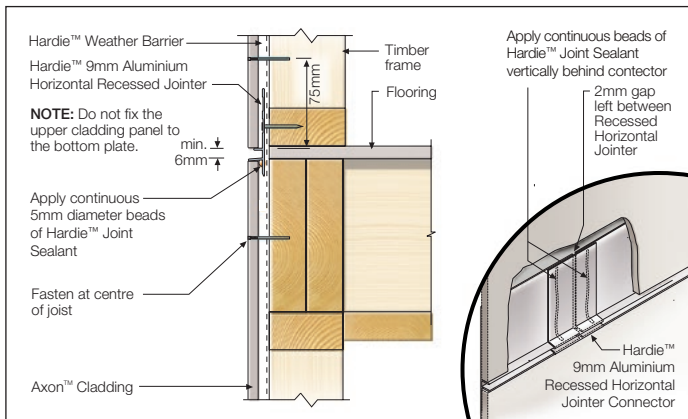

FIGURE 5 UPPER FLOOR JUNCTION OPTION 1

NOTE: Join the Hardie™ 9mm Aluminium Horizontal h flashings on intermediate studs and not off stud or behind sheet joints.

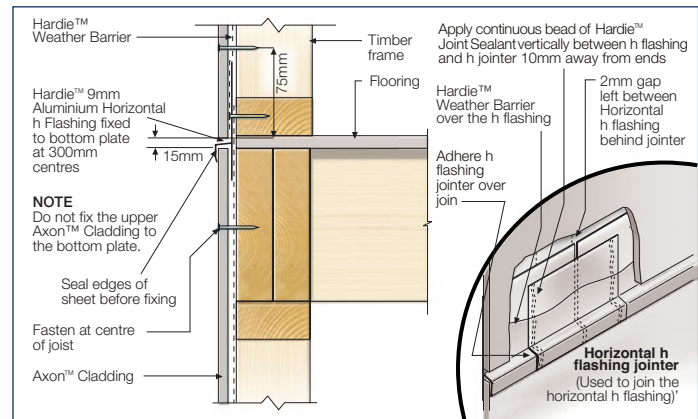

FIGURE 6 UPPER FLOOR JUNCTION OPTION 2

EXTERNAL CORNER DETAILS

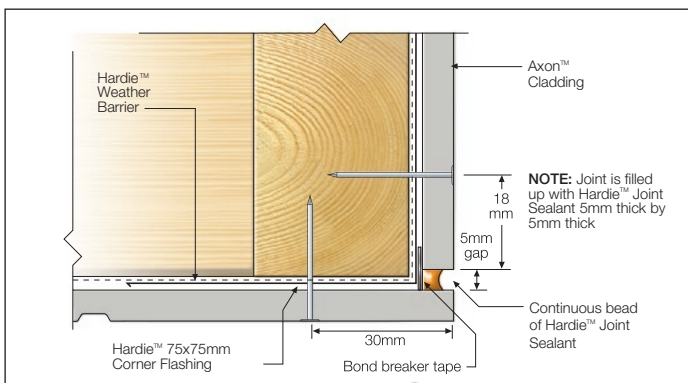

FIGURE 7 SEALANT FILL OPTION

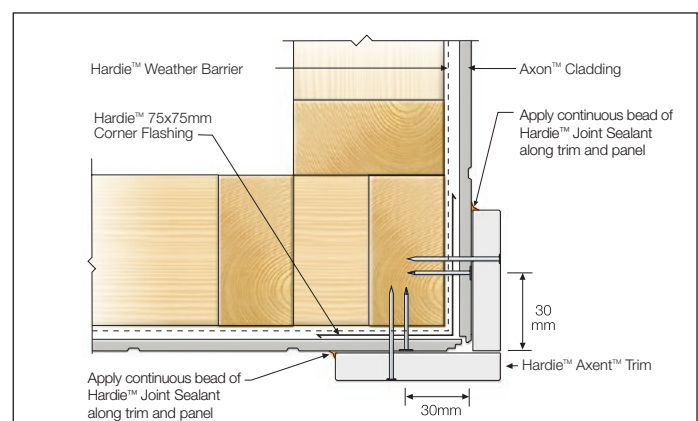

FIGURE 8 TRIM CORNER OPTION

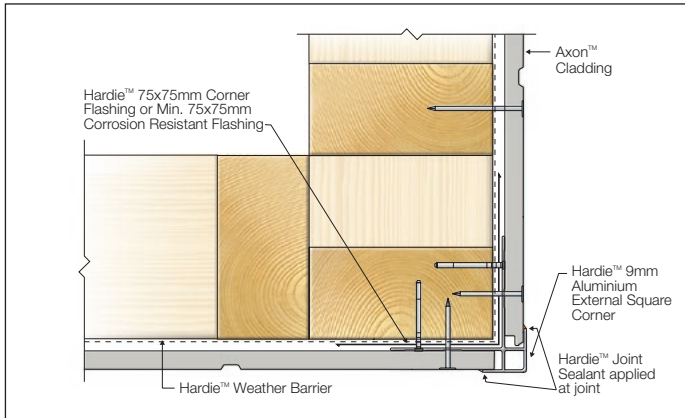

FIGURE 9 ALUMINIUM BOX CORNER OPTION

INTERNAL CORNER DETAILS

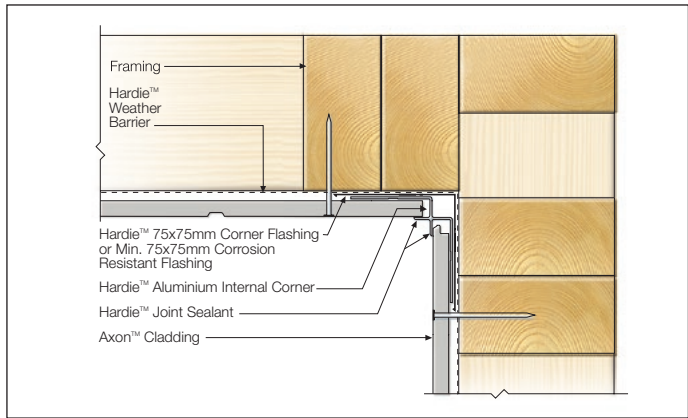

FIGURE 10 ALUMINIUM CORNER DETAIL

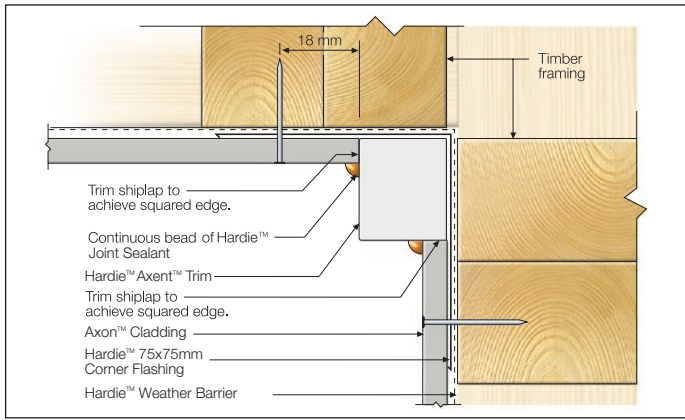

FIGURE 11 TRIM CORNER OPTION

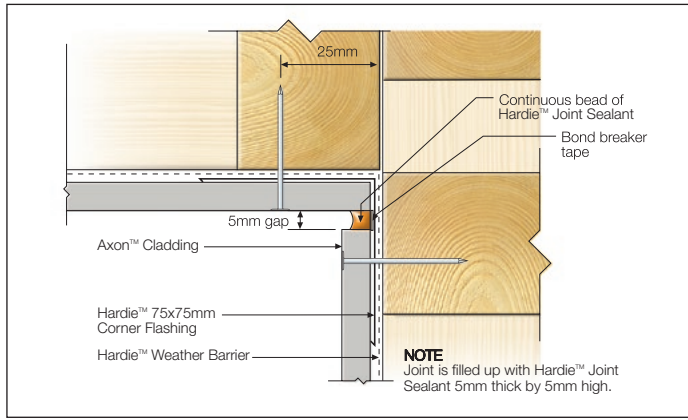

FIGURE 12 SEALANT FILL OPTION

WINDOW DETAILS

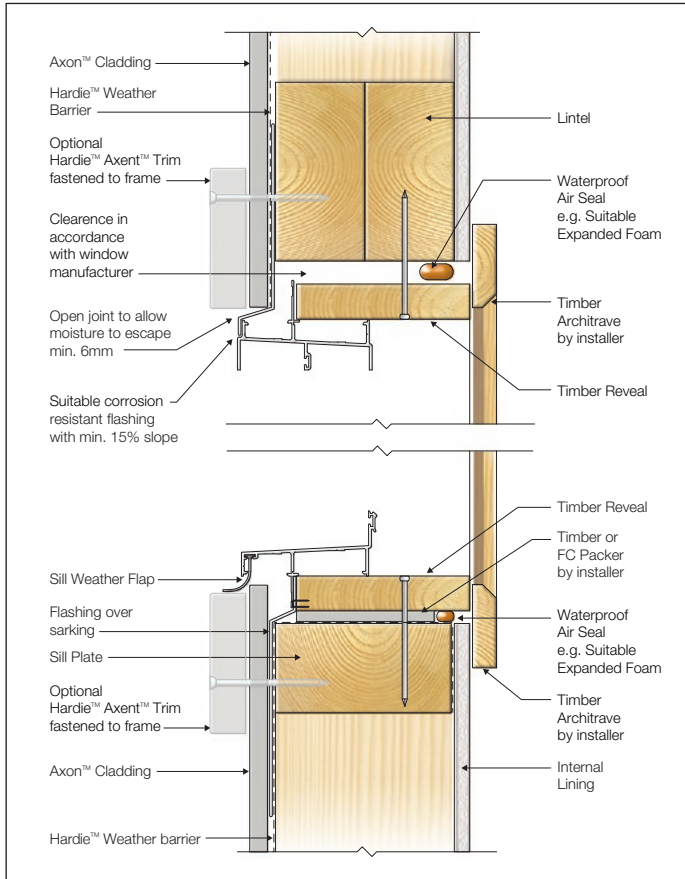

FIGURE 13 WINDOW HEAD AND SILL - TRIM

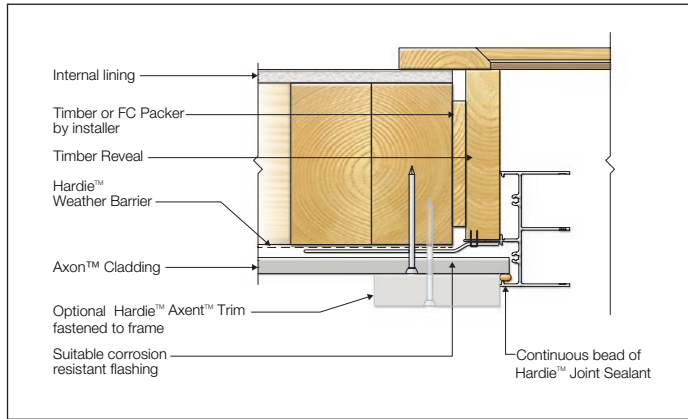

FIGURE 14 WINDOW JAMB - TRIM

8 Construction Details - Cavity Fix

JUNCTION DETAILS

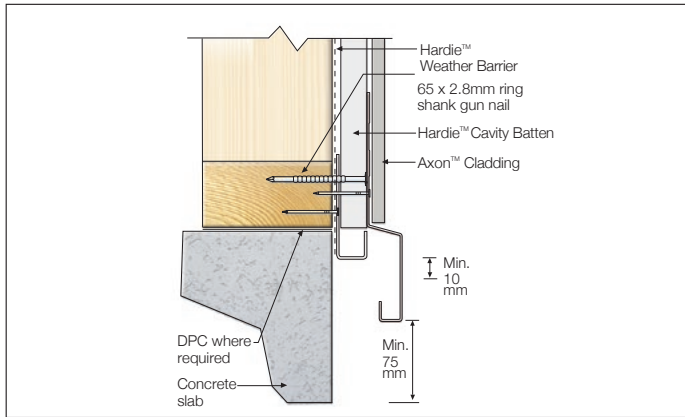

FIGURE 15 SLAB EDGE DETAIL

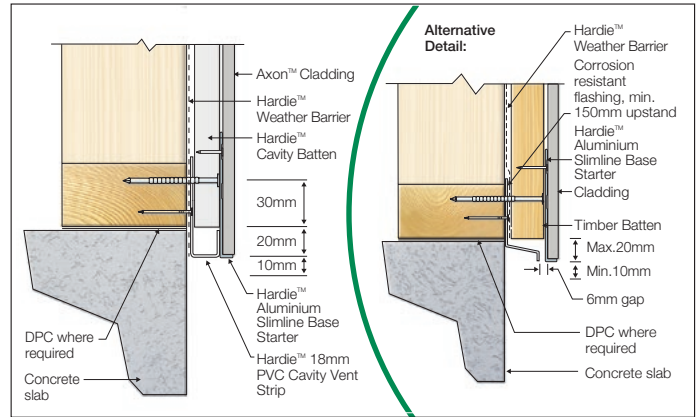

FIGURE 16 ALTERNATIVE SLAB EDGE DETAILS

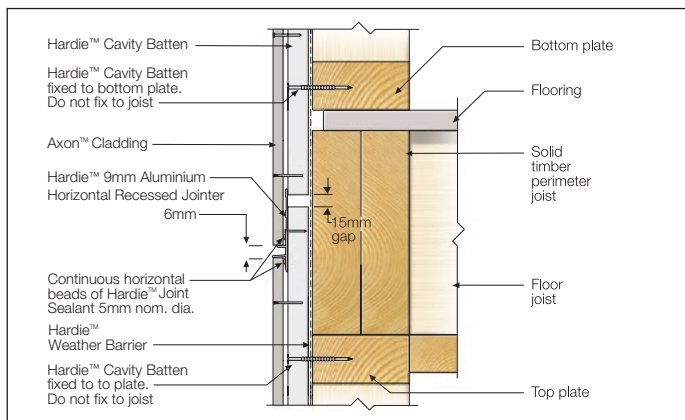

FIGURE 17 FLOOR LEVEL JUNCTION - HORIZONTAL RECESSED JOINTER

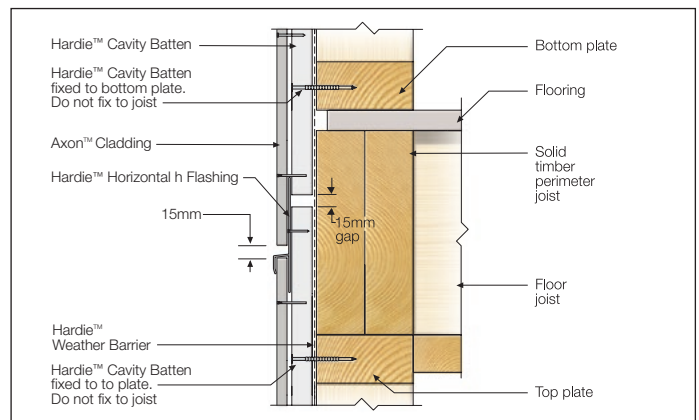

FIGURE 18 FLOOR LEVEL JUNCTION - HORIZONTAL H FLASHING

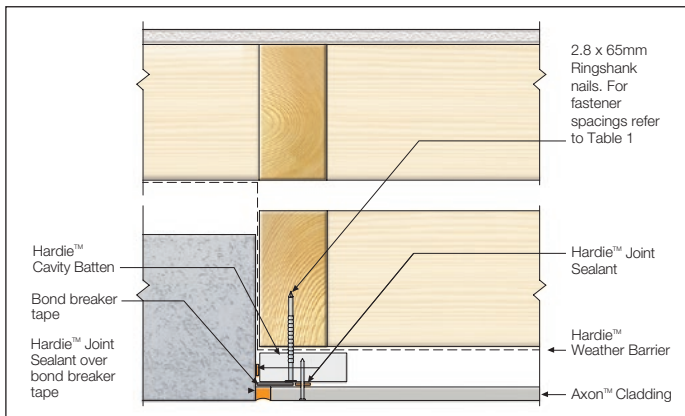

FIGURE 19 ABUTMENT DETAIL

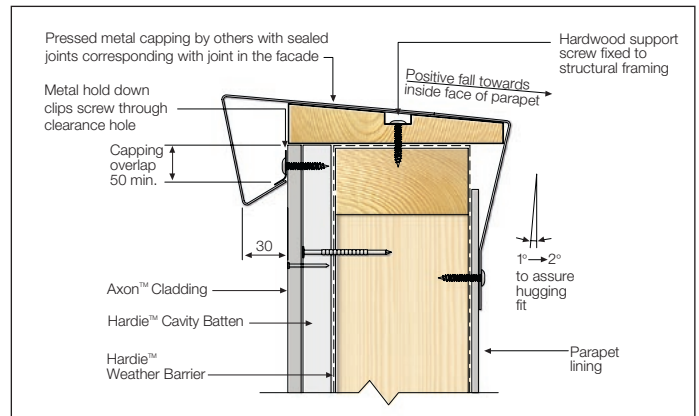

FIGURE 20 PARAPET CAPPING DETAIL

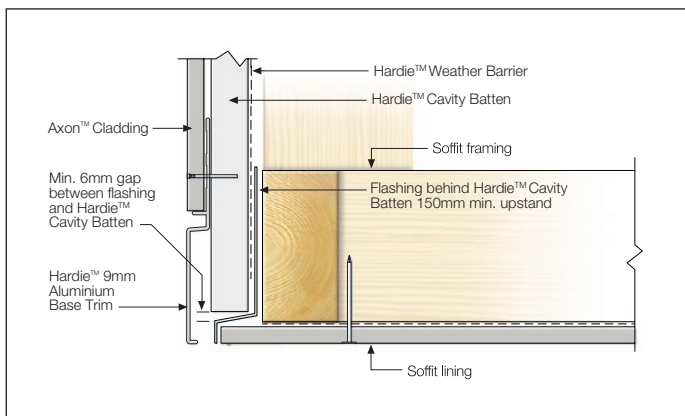

FIGURE 21 FACADE/SOFFIT JUNCTION

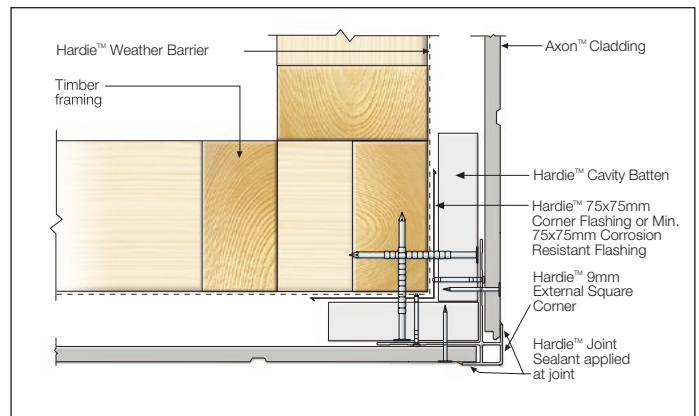

FIGURE 22 ALUMINIUM BOX CORNER OPTION - CAVITY BATTEN

EXTERNAL CORNER DETAILS

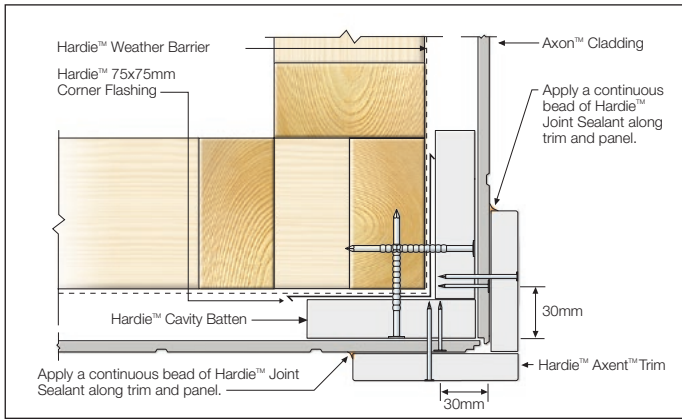

FIGURE 23 TRIM CORNER OPTION - CAVITY BATTEN

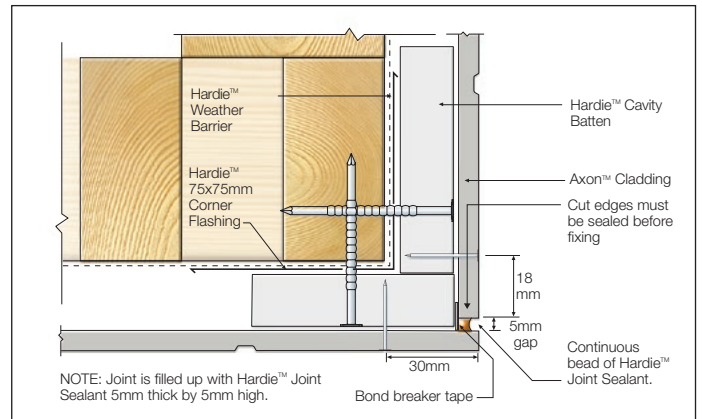

FIGURE 24 SEALANT FILL OPTION - CAVITY BATTEN

INTERNAL CORNER DETAILS

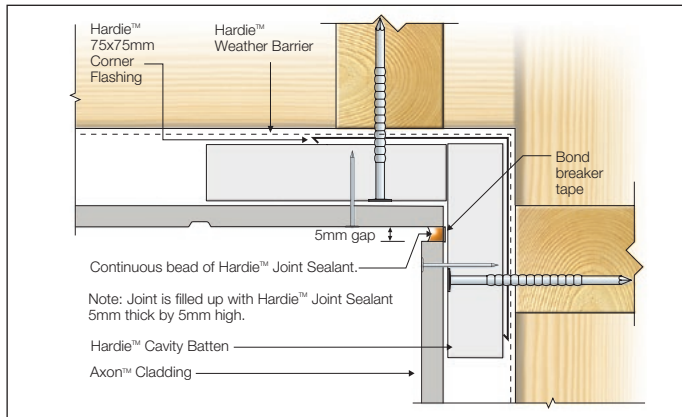

FIGURE 25 SEALANT FILL OPTION - CAVITY BATTEN

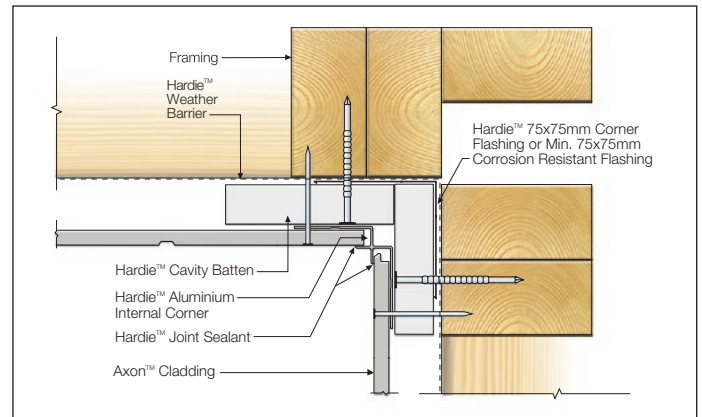

FIGURE 26 ALUMINIUM CORNER DETAIL - CAVITY BATTEN

WINDOW DETAILS

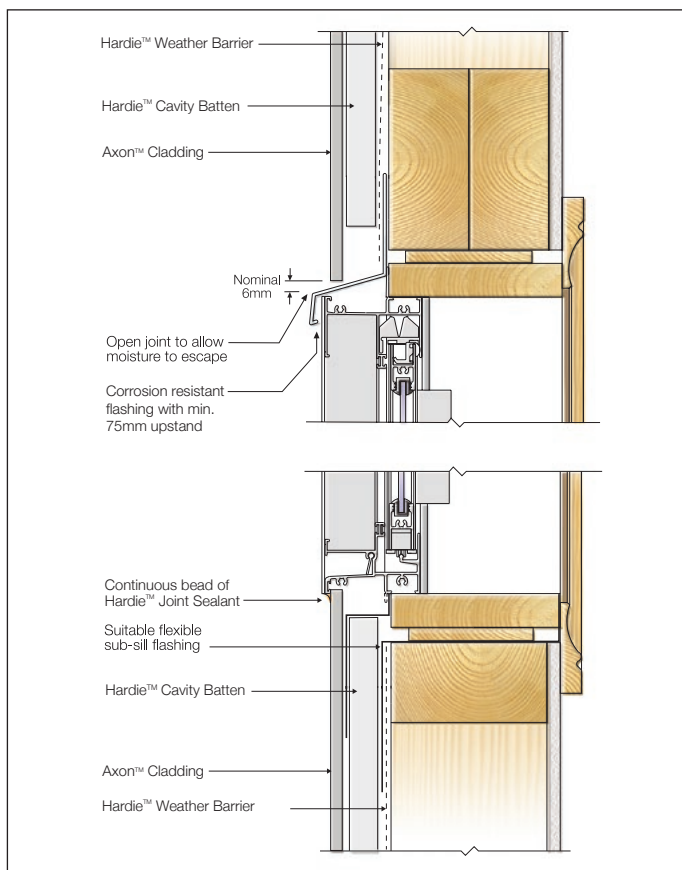

FIGURE 27 WINDOW HEAD AND SILL - CAVITY BATTEN

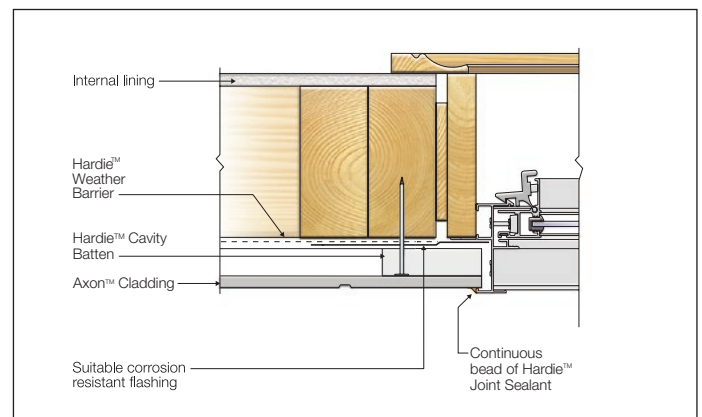

FIGURE 28 WINDOW JAMB - CAVITY BATTEN

9 Finishes and Maintenance

SURFACE PREPARATION

Ensure the surface is dry, clean and any overdriven nails are patched in accordance with this specification.

Any slightly overdriven brad nails (1mm max.) may be repaired using a suitable external grade filling agent.

For overdriven screws (2-3mm), fill in with a two-part epoxy (e.g. Megapoxy P1) and blend with Hardie™ Base coat.

Sealants

James Hardie recommends the use of Hardie™ Joint Sealant, which is a paintable polyurethane sealant. If using an alternative sealant, it must be a quality polyurethane sealant compatible with fibre cement and the specified paint system if coated. Please refer to the manufacturer's instructions for further information.

PAINTING

Axon™ Cladding is primed and ready for painting. All sheets must be dry before painting.

Refer to the project specification for paint requirements. Axon™ Cladding must be painted within 3 months of being fixed. In areas within 1km of a coastal area or corrosive environment, the Axon™ cladding must be painted immediately after fixing sheets to minimise contamination build up on the heads of the fasteners, as it may lead to fastener corrosion.

James Hardie recommends the application of two coats minimum of a quality acrylic paint over the pre-primed boards in accordance with the paint manufacturer's specifications. If the screw countersunk option is used, its recommended that any sanded patches are primed before applying the two final coats. Some environments require special coatings including coastal areas. Painting selection and specifications are dependant on the paint chosen. Refer to the paint manufacturer for further information and details of their warranty.

STAINING

Some paint manufacturer's such as Cabot's and Watty offer stain systems that they have tested with Hardie™ fibre cement products. For a stained look, contact our Technical Team on 13 11 03.

MAINTENANCE

The extent and nature of maintenance will depend on the geographical location and exposure of the building. As a guide, it is recommended that basic normal maintenance tasks shall include but not be limited to:

- Washing down exterior surfaces every 6-12 months*
- Periodic inspections should be made to ensure fasteners are adequately securing the sheets to framing.
- Re-applying of exterior protective finishes*
- Maintaining the exterior envelope and connections including joints, penetrations, flashings and sealants that may provide a means of moisture entry beyond the exterior cladding.
- Cleaning out gutters, blocked pipes and overflows as required.
- Pruning back vegetation that is close to or touching the building.

*Refer to your paint manufacturer for washing down and recoating requirements related to paint performance.

10 Product Information

PRODUCT INFORMATION

Material

The basic composition of Hardie™ fibre cement products is Portland cement, ground sand, cellulose fibre, water and proprietary additives.

Hardie™ fibre cement products are manufactured to AS/NZS 2908.2 'Cellulose-Cement Products-Flat Sheet'. These are also compliant with equivalent standard ISO 8336 'Fibre-cement flat sheets - Product specification and test methods'. For product classification refer to the relevant Physical Properties Data Sheet.

Durability

Resistance to Moisture/Rotting

Axon™ Cladding has demonstrated resistance to permanent moisture induced deterioration (rotting) by passing the following tests in accordance with AS/NZS 2908.2:

- Water permeability (Clause 8.2.2)
- Heat rain (Clause 6.5)
- Warm water (Clause 8.2.4)
- Soak dry (Clause 8.2.5)

Resistance to fire

Axon™ Cladding is suitable where non-combustible materials are required in accordance with C2D10 and H3D2 of the National Construction Code (NCC) Vol 1 and 2 respectively.

Hardie™ fibre cement building products have been tested by CSIRO in accordance with AS/NZS 3837 and are classified as conforming to Group 1 material (highest and best result possible), with an average specific extinction area far lower than the permissible 250m²/kg, as referenced in Specification C2D11(1) of the National Construction Code (NCC).

Resistance to Termite Attack

Based on testing completed by CSIRO Division of Forest Products and Ensis Australia, Hardie™ fibre cement building products have demonstrated resistance to termite attack.

Alpine Regions

In regions subject to freeze/thaw conditions, all fibre cement external cladding must be installed and painted in the warmer months of the year where the temperature does not create freeze and thaw conditions or paint issues. The cladding must be painted immediately after installation. In addition, fibre cement cladding must not be in direct contact with snow and/or ice build up for extended periods, e.g. external walls in alpine regions subject to snow drifts over winter.

Furthermore, a reputable paint manufacturer must be consulted in regards to a suitable product, specifications and warranty. The paint application must not be carried out if the air temperature or the substrate temperature is outside the paint manufacturer's recommendation including the specified drying temperature range

Hardie™ external cladding products are tested for resistance to frost in accordance with AS/NZS 2908.2 Clause 8.2.3.



**For information and advice
call 13 11 03 | [jameshardie.com.au](https://www.jameshardie.com.au)**

Australia October 2023

© 2023 James Hardie Australia Pty Ltd ABN 12 084 635 558
™ and © denote a trademark or registered trademark owned by James Hardie Technology Limited.
Codemark®, Colorbond®, Megapoxy®, Hitachi, Cabot's, Watty!® and Makita® are trademarks or registered trademarks of their respective owners and are not owned by James Hardie Technology Limited.

