



**HEMPBLOCK**  
AUSTRALIA

# Australian LB 300 HempBLOCK Installation Manual

Australian — V1 August 2023 HempBLOCK

International



# Table of Contents

<b>1. Index V1 2023.....</b>	<b>3</b>
<b>2. LB 300 general information.....</b>	<b>4</b>
2.1. The work space.....	5
2.1.1. Safety.....	6
2.1.2. Tools.....	10
2.1.3. Storing and moving blocks.....	23
2.1.4. Perlite.....	24
2.1.5. FRP.....	28
<b>3. What is a HempBLOCK? .....</b>	<b>30</b>
<b>4. Building a LB 300 HempBLOCK wall.....</b>	<b>35</b>
<b>5. 1 Floor preparation and the first blocks.....</b>	<b>36</b>
5.1. Concrete floor.....	37
5.2. Wooden floor.....	52
<b>6. 2 A Erecting walls with the Steel Reinforced Concrete load bearing system .....</b>	<b>58</b>
<b>7. 2 B Erecting walls with the Steel Post and Beam load bearing system .....</b>	<b>87</b>
<b>8. 2 C Erecting walls with the Fibre Reinforced Polymer load bearing system .....</b>	<b>126</b>
<b>9. Wall heights, interior walls and second level floors.....</b>	<b>161</b>
<b>10. Embedding services in the wall.....</b>	<b>167</b>
<b>11. Render, wall finishes, windows and doors .....</b>	<b>171</b>
<b>12. Battening out walls.....</b>	<b>187</b>

# 1. Index V1 2023

---

## 2. LB 300 general information

---

Welcome to our HempBLOCK installation manual.

Here you will find all you need and beyond to construct walls with the LB 300 HempBLOCK.

Grateful thanks to everyone that made this manual happen.

## 2.1. The work space

---

1. Safety, PPE
2. Storing and moving blocks
3. Tools
4. Perlite, vermiculite, cement, plasticiser,
5. FRP, fibre reinforced polymer or CFT Composite Fibre Technology

## 2.1.1. Safety

---

### Note:

This is a general introduction to suggested safety protocols. This is related only to construction with HempBLOCKs, not a full construction safety protocol by any means.

At any time work under the rules of the local safety regulations. Work needs to be supervised by licensed professionals at all times.

Workers must have a construction induction (White Card) card before they can start working on a construction site.

Find your local Safety standards here;

[Local Safety Standards Australia](#)

Disclaimer .....

### 1 Working on heights

### 2 Lifting and cutting the blocks

### 3 Lime render, mortar products

#### 1 Working on heights

Ladders, planks and scaffolding need to be stable and comply to the safety local regulations as per AS 1657–2013.

We would recommend to work on double planks so you can lay the blocks on it without them risking to fall.

Do not lean ladders against a wall that is not finished with load bearing system.

Obey local safety standards. You want to build the wall and move on without injury to you or your fellow workers!

Prefabricated scaffolds should be of the same type and not mixed components, unless the mixing of components has been approved by the manufacturer. AS/NZS 4576:1995: Guidelines for scaffolding.

Further information on temporary edge protection is contained in AS/NZS 4994;

[AS standards fall prevention](#)

#### 2 Lifting and cutting the blocks

##### **Lifting blocks;**

The blocks come in 18 (3 rows) or 24 (4 rows) stacked on wooden pallets. These pallets are treated so they comply to the importation biosecurity regulations.

Wear gloves. The blocks are quite abrasive, after working a full day you will notice this!

In general to work on a block you place it up side down on a table or platform, or on the short, groove side.

Be aware that wet blocks from rain will be heavier and more sensitive to braking.

See further information on manual task and Work Health and Safety Standards here:

[Manual Task Safety](#)

 Note:

Here a demonstration how to handle your block-layer the next block;



<https://www.youtube.com/embed/QaVVpy5Lb6k?rel=0>

- Standard blocks
  - weight 21 kg / 46 lb. Use a little step ladder to get the top blocks of the pallet.  
Grab them firm as possible, preferable position your hands under the blocks. Do not grab them by the tongue or just on one halve of the groove.

\*Column blocks

- weight 18.8 kg / 41 lb  
Grab these with more care not to crush the part with the hollow section.
- U block
  - 17.2 kg / 38 lb  
Try to lift these only by the middle, tongue part. If you grab them by the wings they will most

likely brake.

- Concrete starter block
  - weight 6.5 kg / 14.3 lbThe block layer will deal with these. They should not have to travel far. Cut them with a water cooled brick saw. Stay clear of the concrete dust. Wear protective clothing eye and ear wear. (AS/NZS 1337)
- Broken blocks
  - You can glue blocks and use the good side of a broken block. You can create half column blocks out of broken blocks. Keep them neatly stacked and sorted on empty pallets out of the way.If you detect a crack in a block, be cautious, it is likely to brake. Move it with care, it does not mean that you can not use the block, just be aware.

### **Cutting blocks;**

The blocks can be cut by hand saw and electrical saws.

Safety protocols of any cutting devices is as per local guidelines. Only authorised and trained staff that have followed a safety induction should use these devices.

Find safety information on Band saw use [here](#).

Safety on chainsaws need to be followed as per AS 2727-1984 which documents the guidelines for operators.

Find a guide [here](#).

Do not inhale dust, wear appropriate PPE.

When respirator use is required in the workplace, respirators shall conform to the requirements of AS/NZS 1716.

A Class P1 rated dust mask should suffice. Check the local air quality (is there a breeze or not etc.) when cutting and eventually up grade to a Class P3 dust mask.

Wear long sleeves and pants, (AS 2161) and eye protection (AS/NZS 1337) while cutting the blocks.

### **Storage**

Keep the bagged products stored dry, off the ground and out of sunlight.

There is a recommended use by date of lime mortars and lime renders. See manufactures recommendations.

### **Working with Lime Render Safety**

#### **Lime render / stucco**

Finished HempBLOCK walls are covered with lime render. See chapter [rendering](#).

Freshly mixed lime renders are caustic.

Safety information can be found [here](#)



- Avoid contact with skin and eyes.
- While mixing use respirator and sufficient PPA
- Wear long sleeves for the lime mortar not to irritate your arm skin.  
(see safety protocols above)

Anyone handling the product must have received clear instructions about the safety aspects involved with working with hazardous powder products.

Contact with skin and eyes must be avoided and skin from both wet and dry product.

Lime can irritate the skin if in contact with moisture and could evoke burns. Avoid contact with skin and eyes.

Do not breathe lime dust while transporting, mixing or sieving the product.

Lime based products can cause serious damage to health by prolonged exposure through inhalation.

Wear suitable protective clothing, gloves and eye/face protection.

Wear long sleeves and pants, rubber gloves with fabric cufflinks (AS 2161) and eye protection (AS/NZS 1337)

Eye protection is especially important to avoid liquid lime splashing up while mixing and coming in contact with the eyes.

It is recommended to keep a diluted vinegar / water solution on site in a mister to wash skin area's affected by the lime-paste.

Bags of mortar and lime are 25 kg / 55 lb.

Lift with caution.

Dispose of empty bags appropriately.

### **Working with Lime Mortar Safety**

#### **Lime mortar;**

The LB 300 does not require mortar.

May you work with the HB series as well, then you will use a lime mortar provided by us.

Lime mortar is bagged ready to go after mixing with water.

The mortar consists of products based in non-hydraulic lime (in accordance with standard NF EN 459-1 to 3), hydraulic lime (in accordance with standard NF EN 459-1 to 3)

Please find it's MSDOS [here](#).

As above, respect the corrosiveness of the wet render/plaster paste.

## 2.1.2. Tools

---

### Cutting blocks

See chapter [safety](#) for guidance in the use and safety of the following tools.

Mark out cuts with a soft pencil or wax crayon and a square.

The blocks can be cut by:

- Hand saw
  - a wide handsaw will do the job well, especially if needing to cut just the tongues. To cut through a full block will take some time, hence we use an
- Electrical chain saw
  - Minimal blade length recommended to be 400 mm / 15.7 Inch. Electrical saws are lighter, do not fume and less dangerous and less noisy than a petrol chainsaw. Battery operated chainsaws are recommended. We would not recommend a petrol operated chainsaw.







- Electric saw
  - There are saws available that have a moving blade in between two guides.



- Band saw\*



Here [a short video](#) of cutting a Column block in half to wrap around a steel bracing element.

- Electric band saws are handy as their cut is minimal, fast and more precise. You need one with a clearance of at least 350 mm / 13.77 inch. They standard draw a bit of power so you will need to have a higher amperage electrical safety switch and cabling. A dust extractor is recommended. They are big and heavy. You will need to store them safely and out of the weather.

Find safety information [here](#).

Safety of the above cutting devices is as per local guidelines. Only authorised and trained staff that have followed a safety induction should use these tools.

Do not inhale dust, wear appropriate PPE.

Wide spade drill bits are used to drill bigger holes to insert bolts and fasteners in the system that is

embedded in the blocks.

You can create a cutting table with grooves so the saw blade can go all the way trough without cutting the table surface.



To make a plunge cut or cutting the 150 × 150 mm column hole;

1. Mark out the square on the tongue side
2. Lay the block on the ground and make the initial cuts
3. Move the block onto table height and finish the remaining cuts

For example:

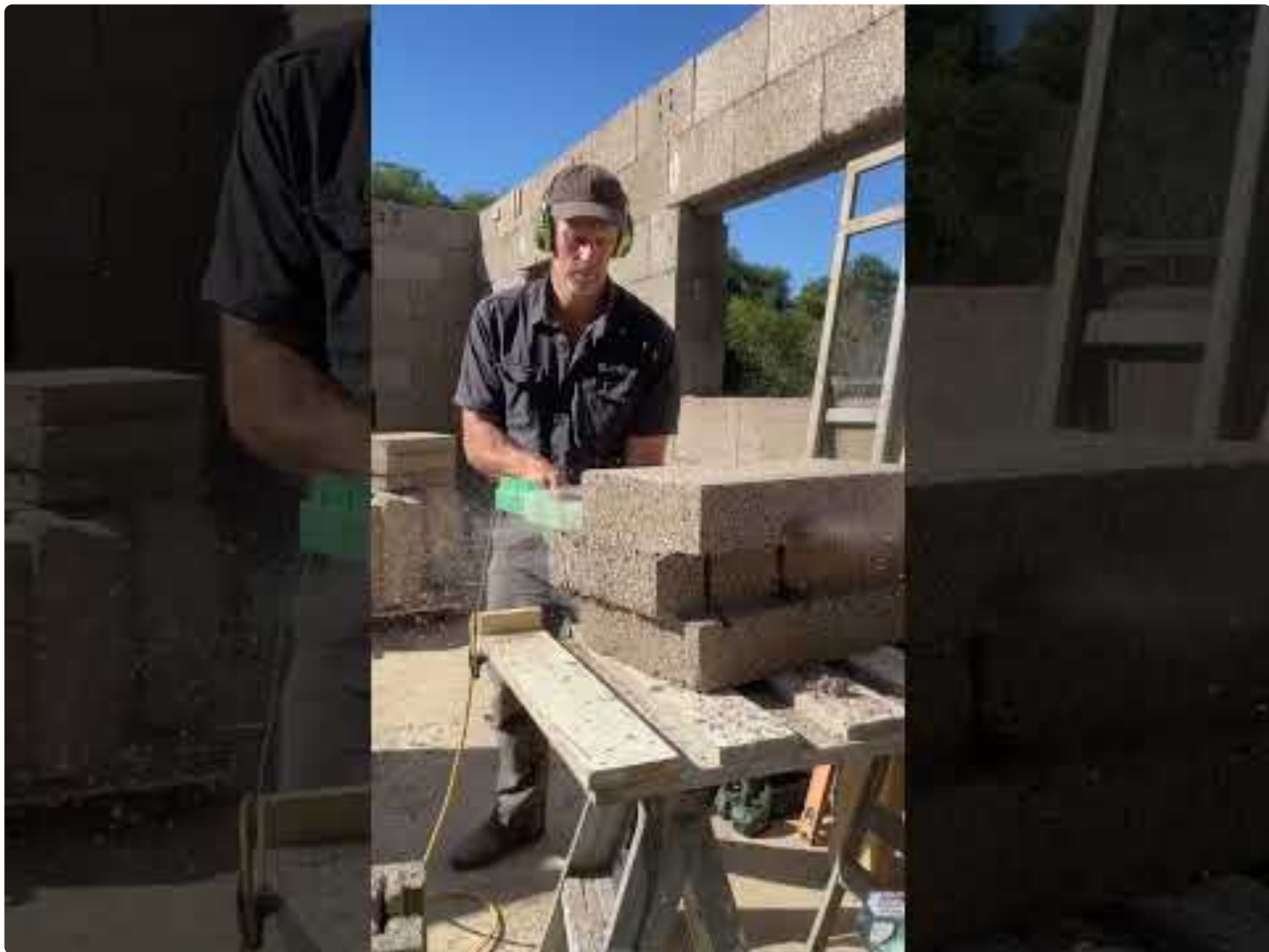

<https://www.youtube.com/embed/XLIDflqJlec?rel=0>

### **Interlocking the blocks**

It is handy to create these 'banger plates' so the surface you hammer on connects with the full surface of the block.

Use a 1.5 Kg (3 pound) dead blow over a rubber hammer. They bounce too much.





<https://www.drop>

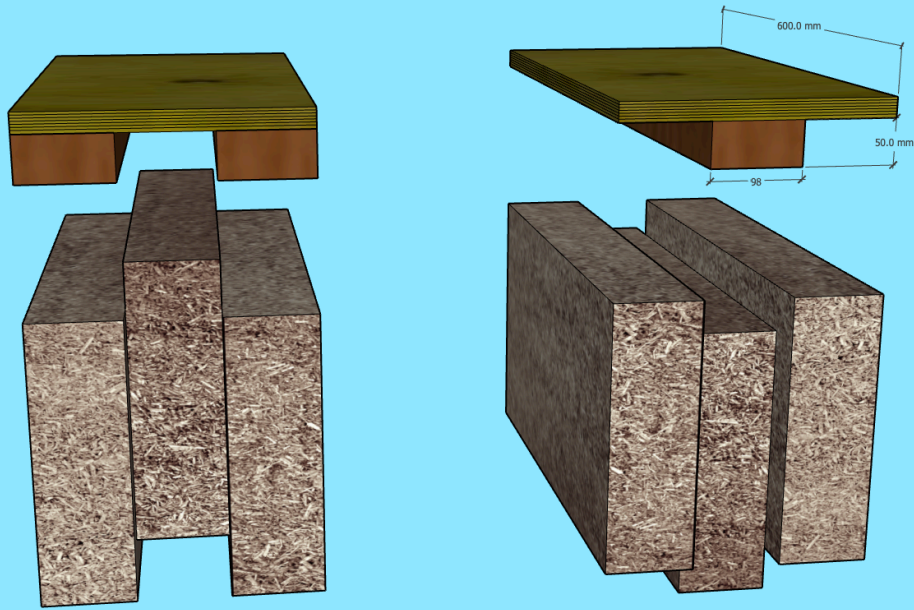





### **Cleaning blocks of debris**

Use a hand broom or air blower either battery operated or with an air compressor to clean the surface of debris (hempcrete particles) so the blocks interlock nice and tight.

It is handy to have several of these in place, one where the wall is constructed, one where the blocks are



cut.

## shaving the corners

Or a rounded one for corners.



You can create rounded corner for a nice spacious effect. This will also make life easier for the renderer (stucco person) because they dont need to reinforce the corners.

Use the straight grate or scrape.

These can also be used to shave the surface down when the block is too high.  
You can make these yourself out of toothed end plates and a bit or timber railing.



## 2.1.3. Storing and moving blocks

---

### Storing and moving blocks

The best scenario is to have (most of) the blocks delivered onto or near the floor surface. This depends on available space and design. You prefer to have the blocks lifted on a raised floor. This will save a lot of time and effort.

If not keep the blocks close to the house site so you can move the pallets with a forklift tractor Manutu or the like.

Use a pallet jack to move the pallets around on the floor.



Make sure the jack fits in the pallet as there are a few versions of spoon spacings out there.

Storing HempBLOCKs is best dry and under cover, especially if stored for longer periods of time.

If the blocks are stored off site we recommend to keep the wrapping around it, as moving the pallets with the wrapping will secure them together.

Cut slots in the wrapping to allow ventilation. The plastic wrapping may create mould where it is in contact with the block for longer periods of time.

Dispose of the wrapping appropriately.

## 2.1.4. Perlite

---

### Perlite

The perlite or vermiculate come in various grades of fineness.

The coarser the aggregate, the harder it will be to get it to flow into the gaps between the load bearing members and the HempBLOCK cavity walls.

Use appropriate PPE such as gloves and airway protection.

### What is vermiculite:

Vermiculite is a volcanic rock deposit, extracted from deep underground. Flakes of this mined product contain minerals like magnesium, aluminum, iron, and silicon. Arranged in thin layers, vermiculite's crystalline structure also includes molecules of water which play an important part in its ultimate transformation. Vermiculite has been used in various industries for over 100 years and its occurrence as a natural mineral (hydrated phlogopite mica) dates back as far as 3.0 billion years old and it is one of the world's most unique minerals. Some of the largest commercial mines in the world who are exclusive Vermiculite suppliers, are located in Southern Africa, Australia, China, Brazil and USA. Once the ore is mined and graded it is then subjected to a furnacing process which is also known as exfoliation. Exfoliation is a process where the ore is heated to approximately 800° C, at this point, water particles in the ore are boiled off and evaporated which then causes rapid expansion to form concertina Vermiculite particles.

Up close, this expanded material looks like glittering, folded bellows or, perhaps, tiny accordions, but someone along the way must've thought the heat-treated particles looked more wormlike. (The word "vermiculite" comes from the Latin word "vermiculari," which means to "be full of worms.")

### What is perlite:

Like vermiculite, perlite also comes from underground. Perlite is derived from volcanic glass which forms when a glassy-looking rock called obsidian comes into contact with water. As with vermiculite, this mined raw material is then heated—this time to temperatures between 1400° and 1800° F.

As the temperatures climb, the crude perlite product expands and pops—not unlike popcorn—resulting in the airy, sphere-like particles we know as perlite. Perlite is typically bright white, with the look and feel of Styrofoam. However, closer inspection reveals a texture closer to pumice. If you were to magnify an individual piece of perlite, you'd see that the surface is pocked and fissured.

Applicable ASTM Standards;

Perlite aggregate conforming to ASTM Designation C 332, Group I.

C 150: Specifications for Portland Cement

C 332: Specifications for Lightweight Aggregates for / Insulating Concrete

Why we use a perlite / vermiculite cement mix:

Both aggregates are lightweight, cost effective and easy to mix and can be purchased off the shelf.



The perlite mix is 5 x lighter than concrete and uses  $\frac{1}{3}$  of the cement (on the strongest mix ratio) of concrete.

Use cement in accordance with standard NF P18-308.

The perlite or vermiculate come in various grades of fineness.

The more coarse the aggregate, the harder it will be to get it to flow into the gaps between the load bearing members and the HempBLOCK cavity walls. Aim to use the fine (1-2mm ) grade of the perlite. Vermiculite is more cost effective but may not be available in the right grades.

See documentation about Vermiculite [Vermiculite](#)

See documentation about Perlite [Perlite brochure](#).

%(marker-cyan)The recommended volume ratio 1:5 in litre: %

1. perlite; 83 litre
2. cement; 17 litre
3. water; 24 litre
4. plasticiser; a squeeze – 20 ml

The vermiculite mix is the same but may require a bit more water.

Mixing method;

1. enter the water portion into the mixer
2. add a little squeeze of plasticiser then
3. add the amount of cement introduce the perlite mix until the right consistency is achieved.
4. mix for about 3 minutes



Too runny is not desired. Aim for a flowing cream like velocity.

Use the flexible buckets to transport the mix to the wall.

Using these buckets will allow you to have handles and create a great spout to pour into the narrow cavities.



## 2.1.5. FRP

### FRP, Fibre Reinforced Polymer or CFT Composite Fibre Technology

This load bearing system is lightweight, strong and cost efficient compared to steel sections.

Your engineer will supply details of the connections and how the system will have to be assembled.

Find general information on the FRP [here](#).

- Storage\*
  - Because this product is designed to be embedded into the walls away from daylight, the product is not destined to be in contact with direct UV light.  
Keep the products covered by the supplied plastic coverings.
- Cutting \*
  - Cutting the sections can be done by a hand angle grinder, drop saw, both with fibre cutting blades, or metal hand saw.  
Wear protective clothing, gloves and PPE, do not inhale saw dust. We found that wearing long sleeves stop the slight irritation of the skin by the dust.
- Drilling\*
  - Best to use the segmented diamond hole saws for drilling the holes for bolts of any where from  $\varnothing 12 - \varnothing 16\text{mm}$ . Use the jig to drill the holes in a parallel fashion from front to back of the SHS or RHS.



Use inserts where directed. Like with steel hollow sections, bolt connections are either secured by a tube insert or any squash element.

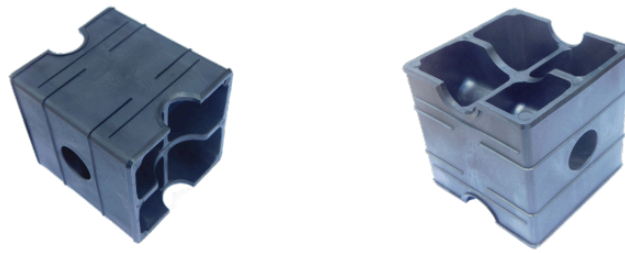

Do not over tighten bolts. Use washers as per engineering specifications.

Only use specified fasteners. Some elements are pop riveted together. Use only specified pop rivets.

# 3. What is a HempBLOCK?

---

**HempBLOCK** is a building block for walls produced in East France.

It is made of Hemp wood and a prompt Lime binder.

HempBLOCK international is an international distributor distributing throughout Australia, New Zealand and the US.

## THE HempBLOCK PROCESS

The HempBLOCK building system consists of dry stack friction fit, interlocking hempcrete blocks incorporating a load bearing construction system. The blocks alone are not considered load bearing but function as a cladding and insulation at the same time.

HempBLOCK Australia is the exclusive distributor of BIOSYS and MULTICHANVRE blocks, re-branded as HempBLOCK in America, Australia, South Africa and New Zealand.

You will find it's certification certificate for Australia here. (coming soon)

You will find it's certification certificate for France [French Certification](#).

## HEMP BLOCKS ARE MADE OF ONLY NATURAL INGREDIENTS:

### HEMP WOOD

The wooden inner particles of the industrial hemp stem. Its innate structure gives it a high thermal hygroscopic and acoustic performance.

### NATURAL PROMPT CEMENT (a unique clay rich lime binder)

Formula that will last the duration of time. Excellent durability. Permeable to water vapour (Hygroscopic). Captures CO2.

### WATER

The blocks are dry stacked interlocking through the tongue and grooves and function as a formwork for a load bearing system, and inner and outer wall skin and insulation at the same time.

The three load bearing system are;

1. Steel reinforced concrete
2. Steel posts and sleeves timber lintels and bond beam
3. FRP posts and sleeves FRP or timber lintels and bond beam

Exterior the walls are finished with a lime render and or sided.

Interior the walls can be finished with a clay or lime render, plastered or sided.

**We have the interlocking (Load Bearing) LB 300;**

### The average weight of a block is: 18Kgs

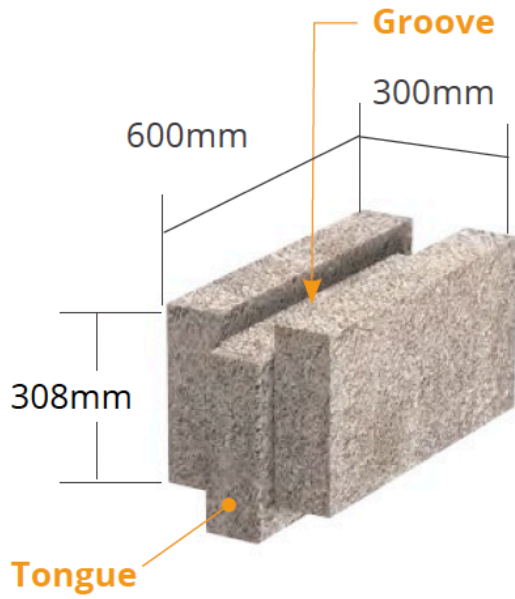

**HempBlock LB 300 S  
(standard)**

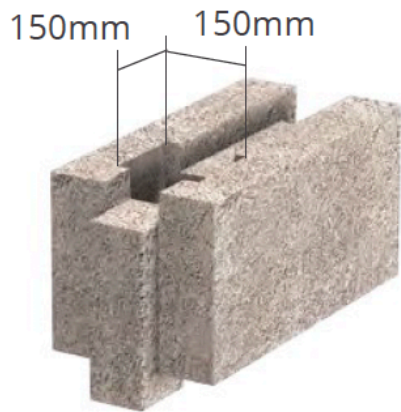

**HempBlock LB 300 C  
(column)**



**HempBlock LB 300 C2  
(double column)**

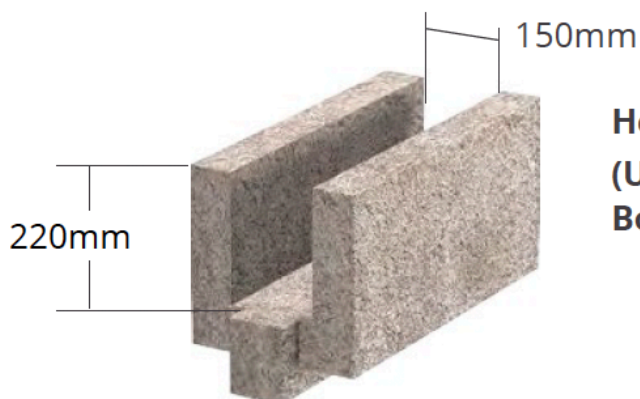

**HempBlock LB 300 U  
(U shape, Lintel &  
Bondbeam)**

## And the mortared (Hemp BLOCK) HB series





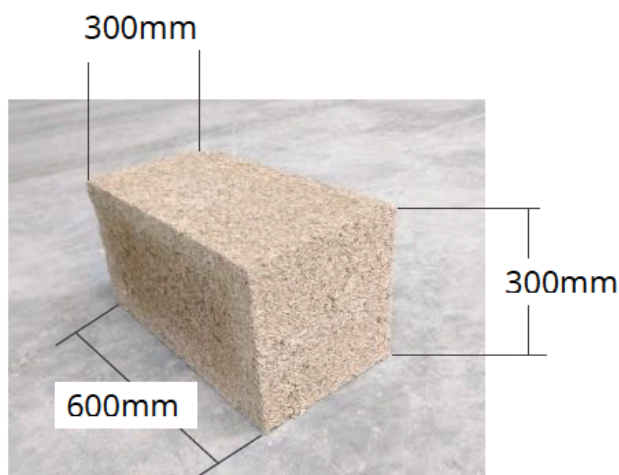
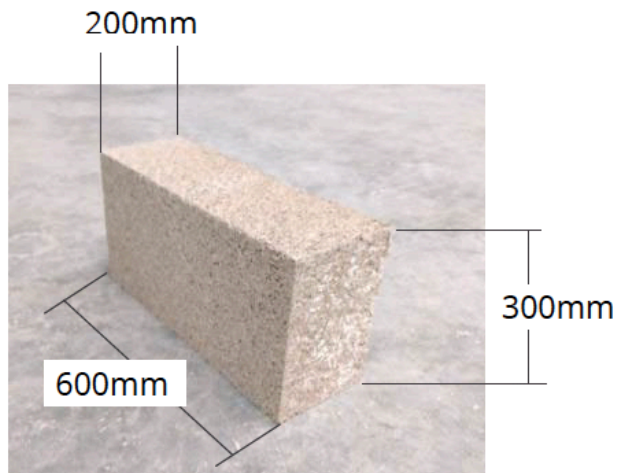
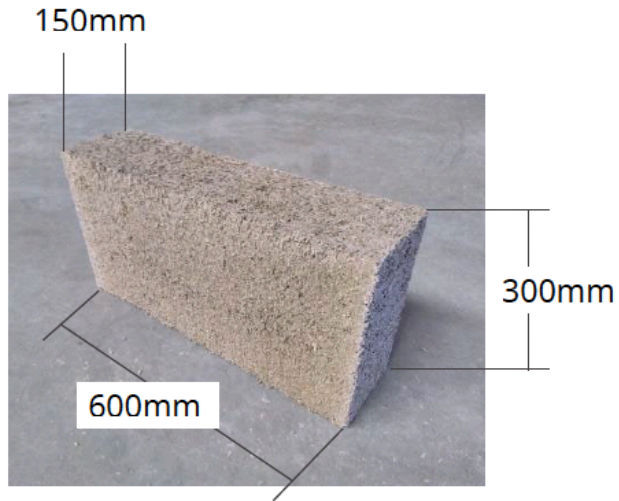
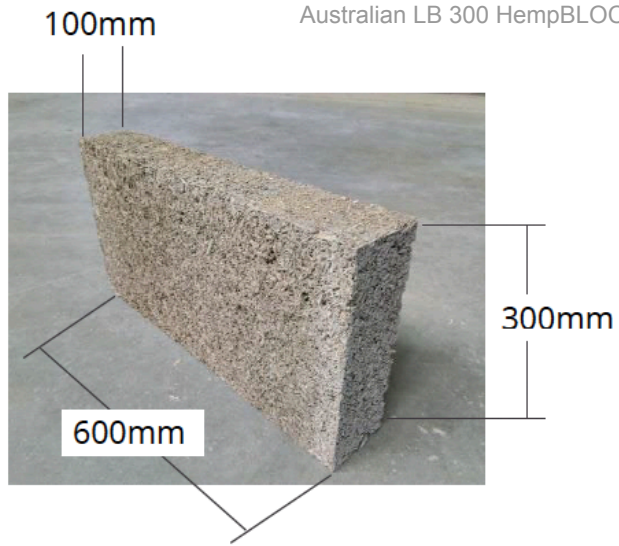

The mortared HempBLOCKs are not part of the certification at the moment.

## 4. Building a LB 300 HempBLOCK wall

---

Let's have a look at the general order of home construction;

1. [Concrete slab](#) / floor or [timber floor installation](#)
2. Erecting the walls and (the different) load bearing systems
3. Roof installation
4. [Other walls](#)
5. [Services rough in](#) (electrical, cabling and hydraulics)
6. [Doors and windows](#)
7. Floor finish
8. Ceiling finish
9. Painting of walls, ceilings, window and door frames, soffits
10. [Rendering and wall finishes](#)
11. Fit out

In the next chapters we will go through the above steps in detail.

# **5. 1 Floor preparation and the first blocks**

# 5.1. Concrete floor

## Design

Generally the architect and engineer will design a suitable sub floor structure.

HempBLOCK walls can be erected on concrete floors, suspended slabs, strip footings and timber floors.

## Retaining walls

The block can **not** be used as a retaining wall block. Hempcrete can not be waterproofed and is not suitable for underground conditions or in constant contact with soil / snow or water.

To allow a bit more internal space, and to let rainwater runoff drop past the wall surface, the wall is best to be set about **50mm** outwards of the substrate (floor) surface.

## Building a wall with LB 300 HempBLOCKs;

### **STAGE 1**

The floor preparation.

**STEP 1** (with concrete starter blocks)

**Set out the wall position on the floor.**

1. Ensure the wall starts 250 mm of the general straight edge off the floor edge so the block overhangs the floor edge by 50mm. A chalk line is a clear and straight way of marking that line.

*In case of using a mortared concrete starter block on a concrete floor;*

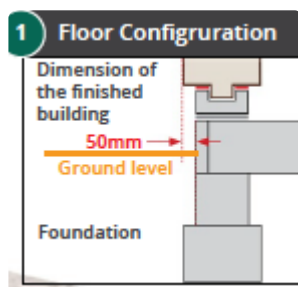

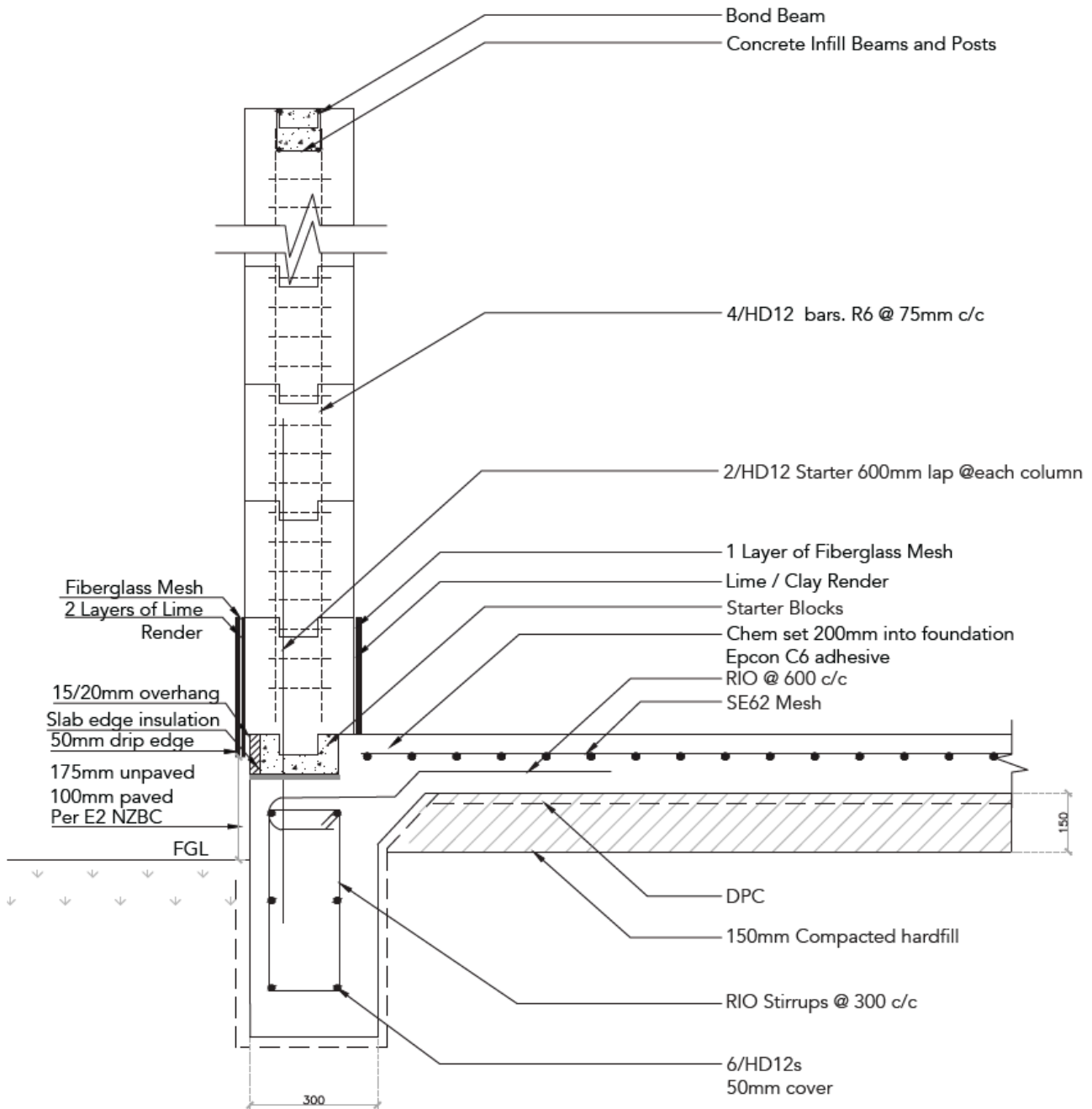

25MPa Concrete 150 x 150 columns  
20MPa Slab

## PERIMETER FOOTING DETAIL

Option 1

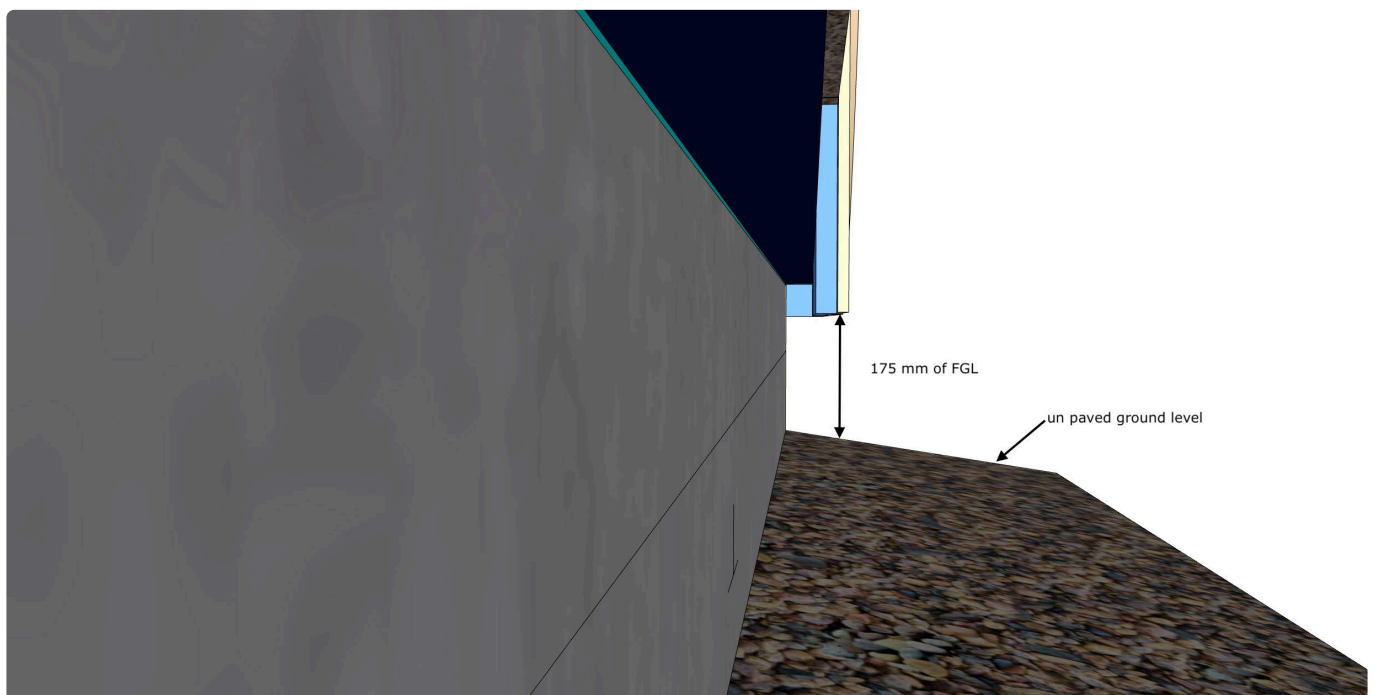
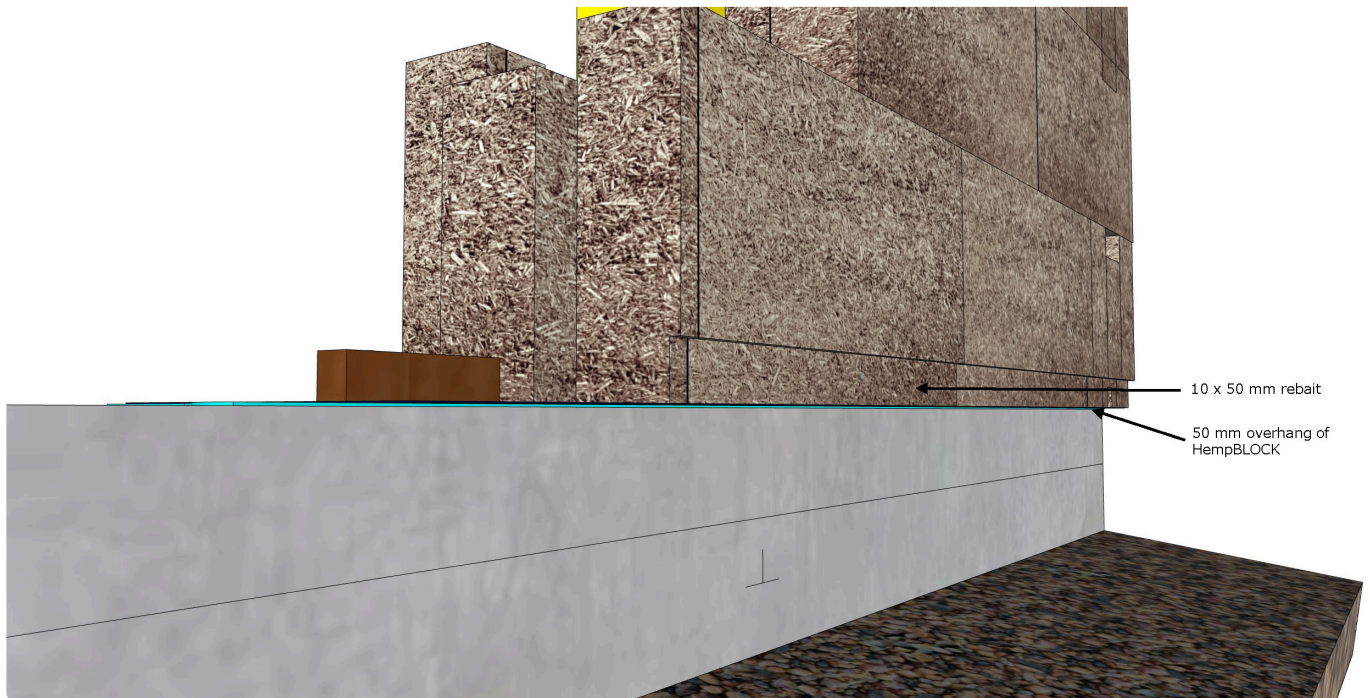

## STEP 2

1. Mark out on a corner where to start your row of starter blocks

Here shown without a slab rebait.

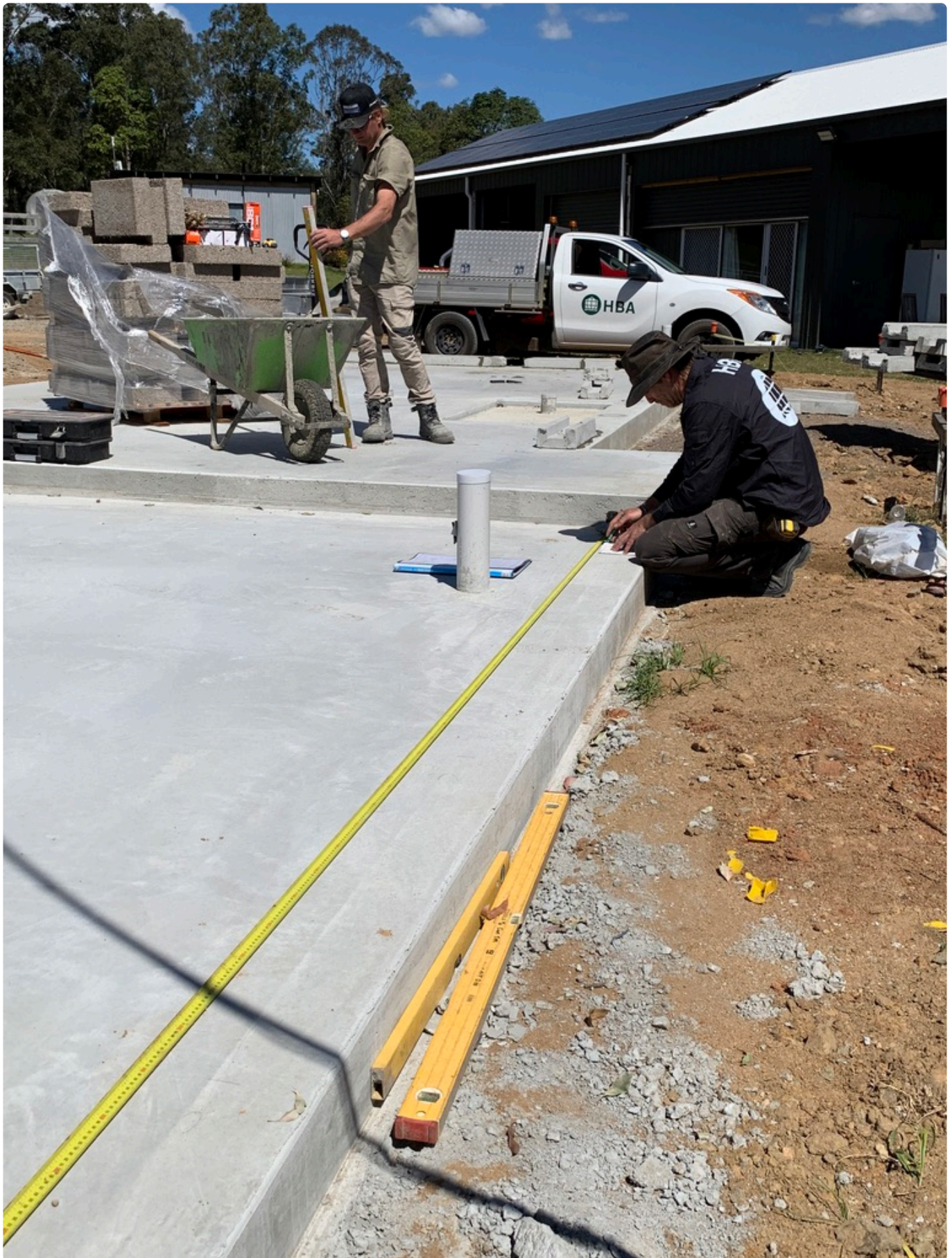

1. Draw a line or flick a chalk line where to position the starter blocks
2. Mark out as per 3D plan\* how the blocks start on the corners.



or for example

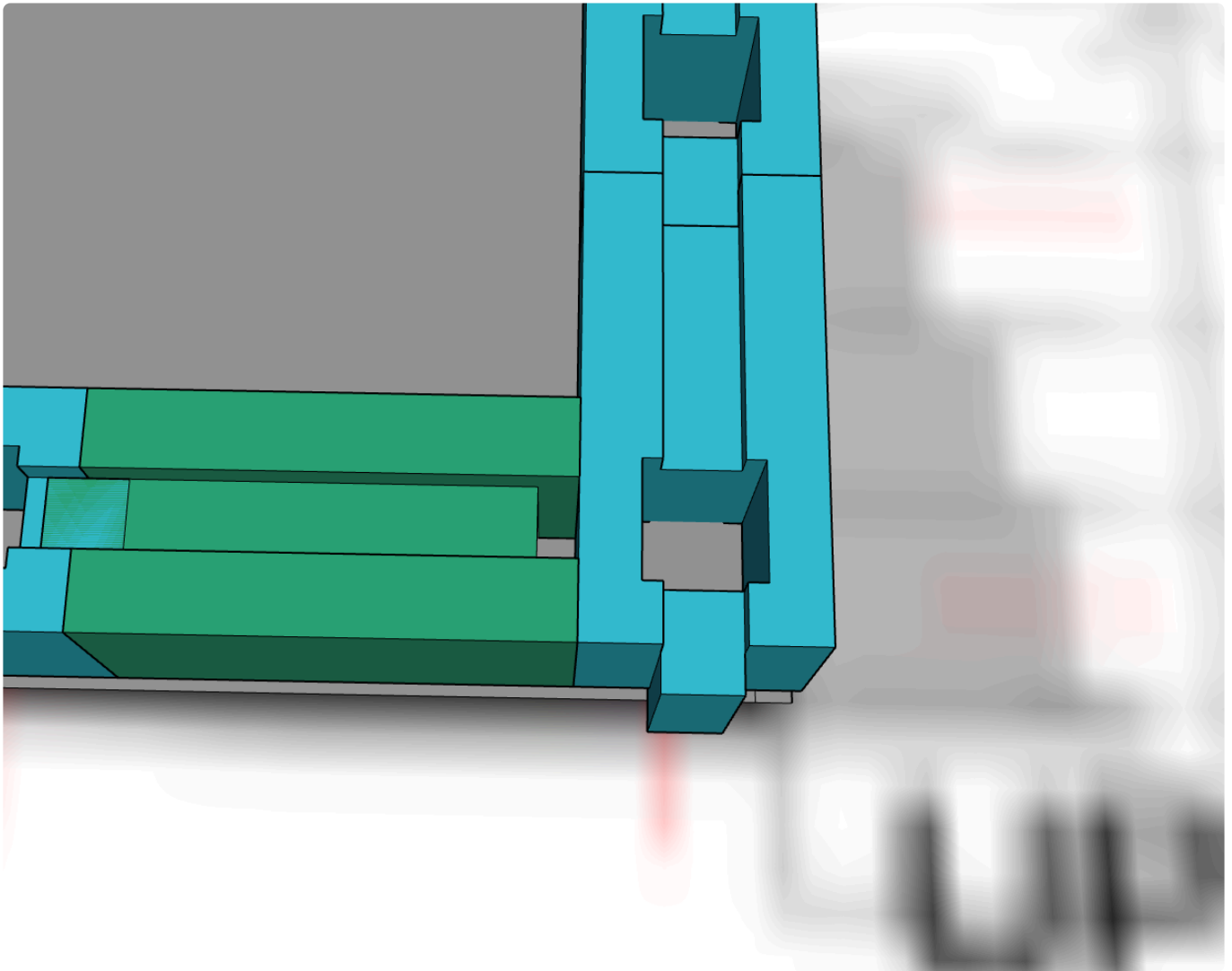

1. From here mark out where the column blocks are positioned related to the window and door openings

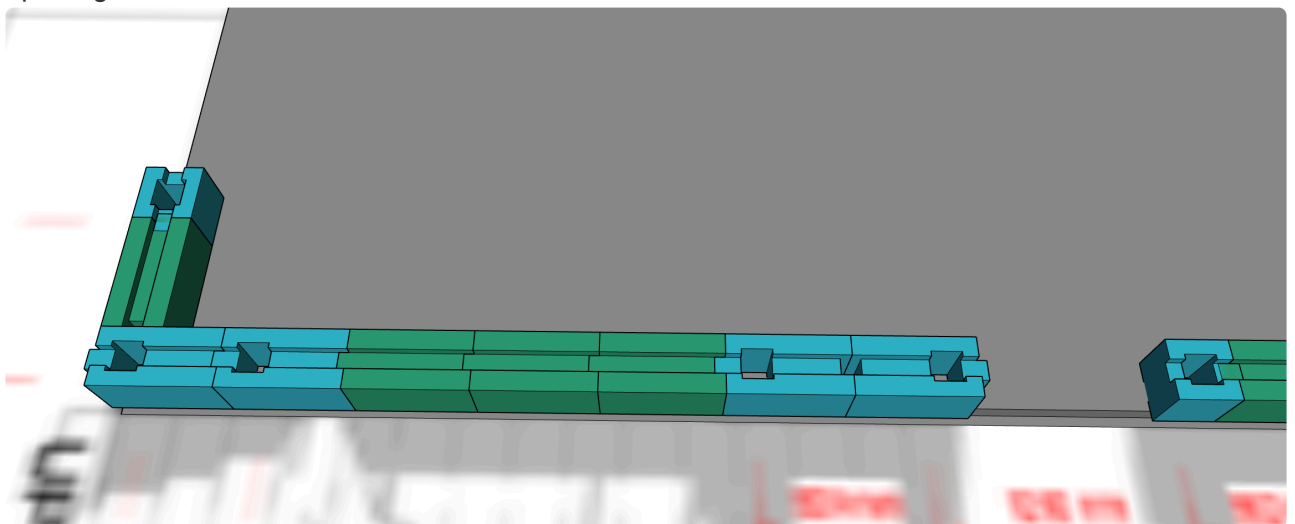

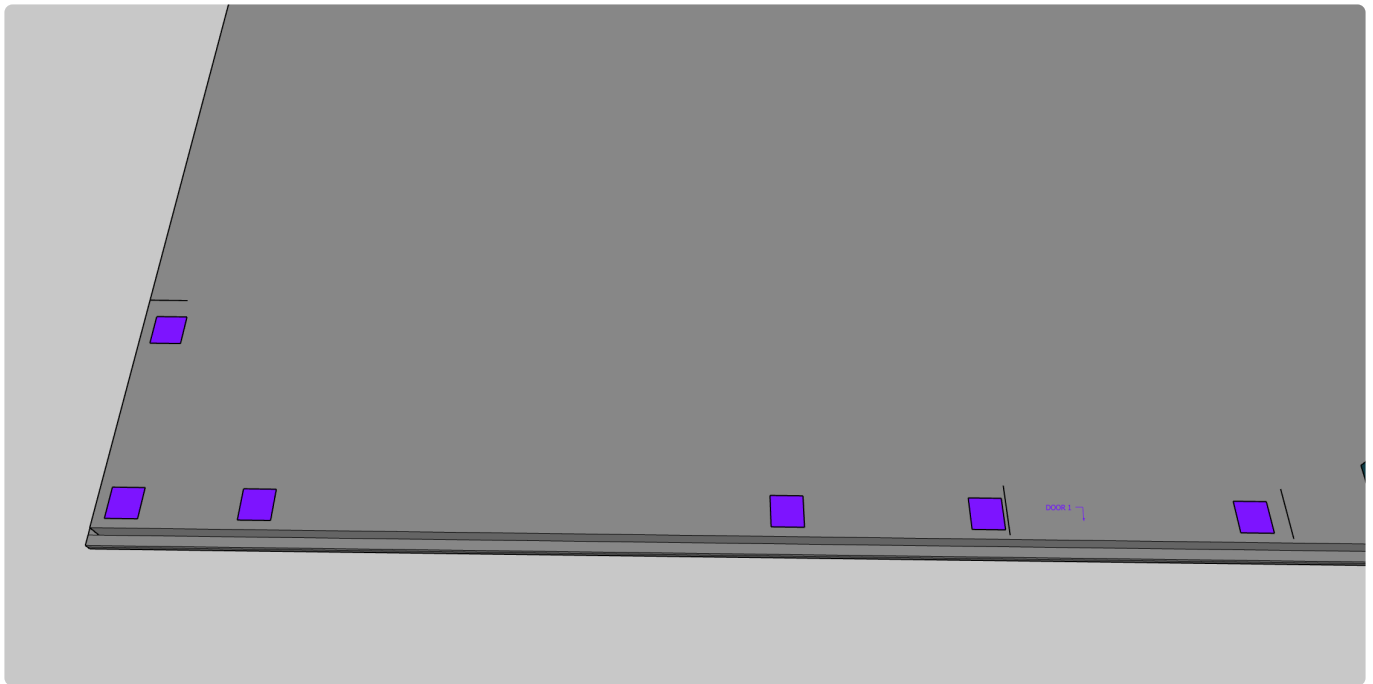

*in case of steel reinforced concrete*

### **STEP 3**

Mark out and drill your starter bar positions and secure them with a chemical anchor or similar as per engineering specifications.

(The starter bars might all have been set out, positioned and fixed in the slab reinforcing beforehand. In that case the concreter will have gone through the steps above to assure the right position of the starter bars. We recommend to set out on a clear slab edge.)





Cap the starter bars for safety.

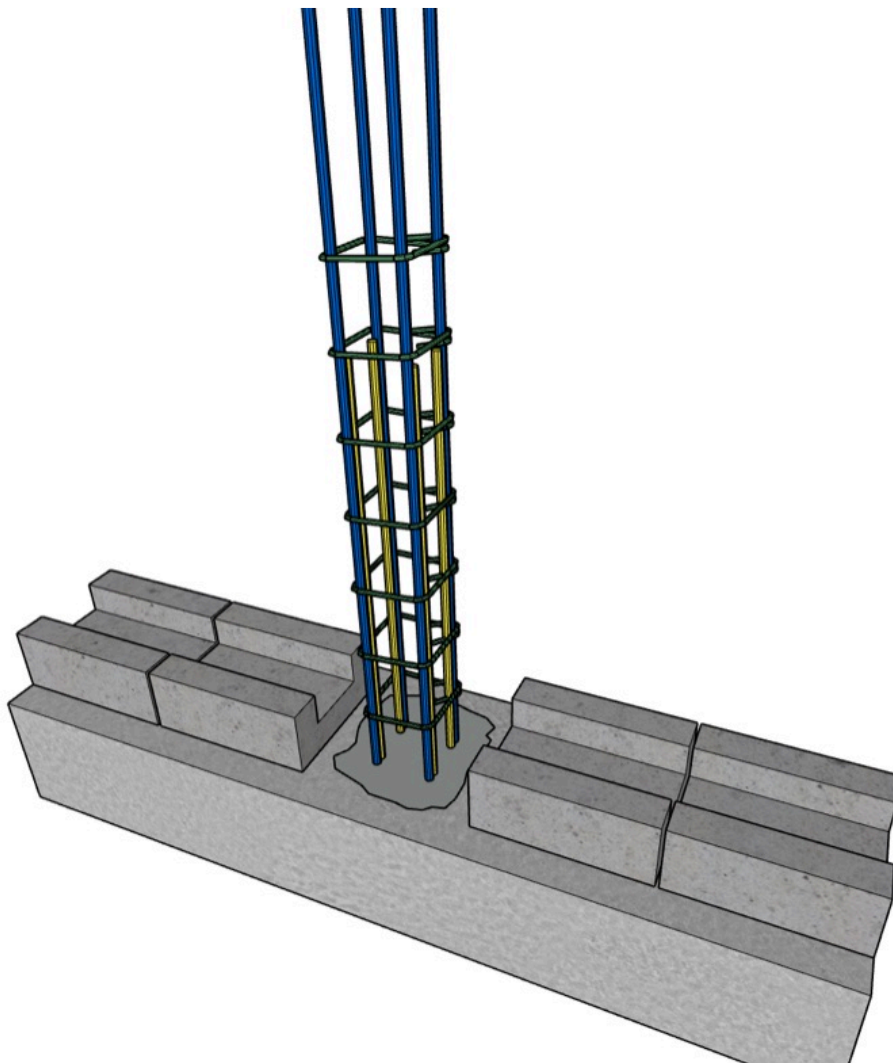

#### **STEP 4**

Ensure the surface around the starter bars is roughed and dusted off to adhere to the concrete when the posts are poured.

#### **STEP 5**

If building regulations require so, get a termite specialist to install a termite barrier to local codes. Termites do not eat the HempBLOCKs but may travel over or under it.

**STEP 6**

Let a block layer lay the concrete blocks on the concrete floor with a cement mortar with a water repellent additive in a straight and level line.





When we are not using the layer of concrete starter blocks, we can place the blocks straight on the floor after waterproofing the contact surface between the floor and the HempBLOCKs.

This will eliminate the following steps;

- purchase and shipping the concrete starter blocks
- needing a block-layer to lay them straight and level
- no need for mortar or cutting concrete blocks
- no need to insulate the inside and outside of the concrete block under the HempBLOCK

*In case of attaching a timber or mod wood tongue to the floor;*

After STEP 1 ;

## **STEP 2**

The floor surface needs to be as level as possible. If the concreters were not able to achieve this you may need to use a levelling compound to establish a neat level floor.

Best is to avoid this and tell your concreters that you need a straight and level floor to start with.

## **STEP 3**

Waterproof the surface where the blocks will sit on the floor surface. Use a membrane waterproofing

paint and if needed a primer on the clean and dry surface.

The damp course would have a minimum of D80 shore DPC. to AS 3.2.2.6.

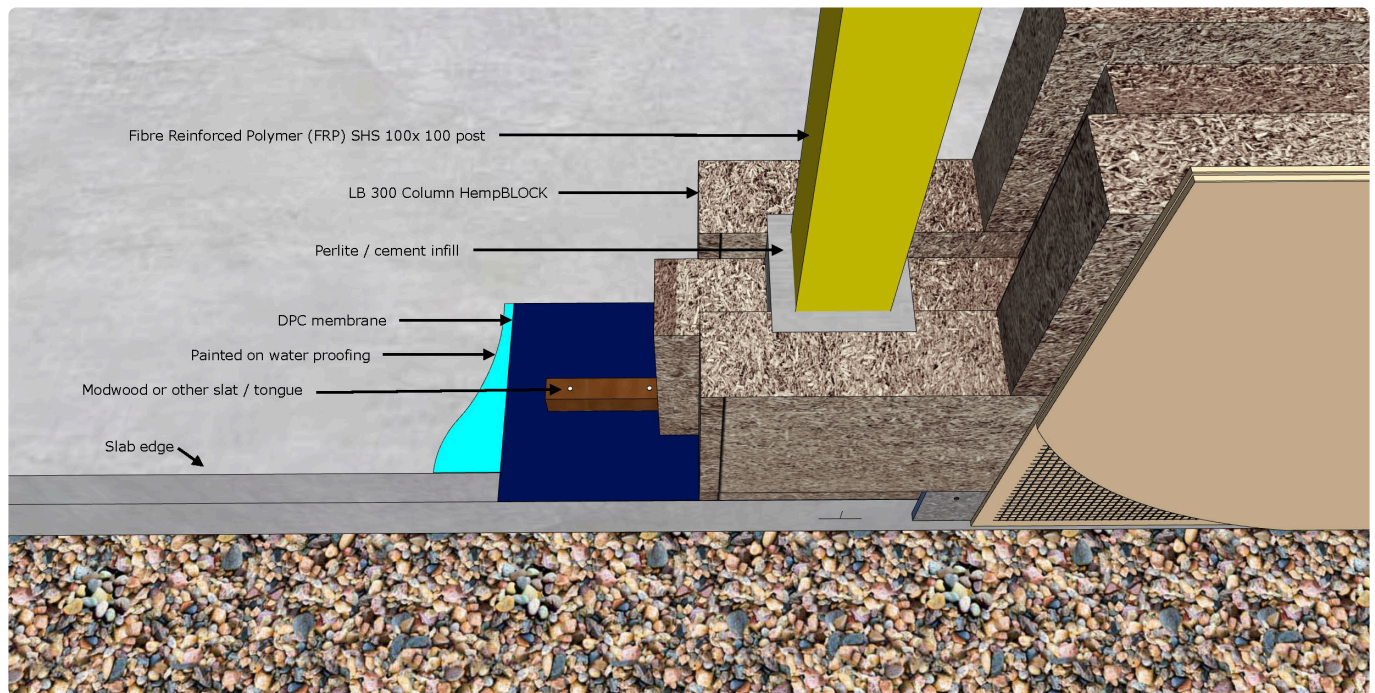

#### STEP 4

Apply a layer of damp-course waterproofing membrane covering the surface where the blocks are positioned on the floor.

Use a sealant / adhesive on the outer sides of the floor to stick and seal the two membranes.

#### STEP 5

If building regulations require so get a termite specialist to install a termite barrier to local codes.

This can be done in a variety of configurations depending on the material / system used. The termite barrier could also act as a damp course membrane at the same time.

#### STEP 6

Mark out the thickness of tongue in the centre of the block. Minimal 35mm wide and 35 mm high. (Remember the block will sit 250mm in from the floor edge.)

#### STEP 7

Fasten the modwood / hardwood tongue with regular intervals to secure to the floor surface. Exclude the spaces allocated for the load-bearing system.

#### STEP 8

When the load bearing system is FRP posts:

Affix the brackets that will connect with the steel or FRP posts or steel feet on the surface.



(use concrete screws or chemical anchor bolts as per engineering specifications)

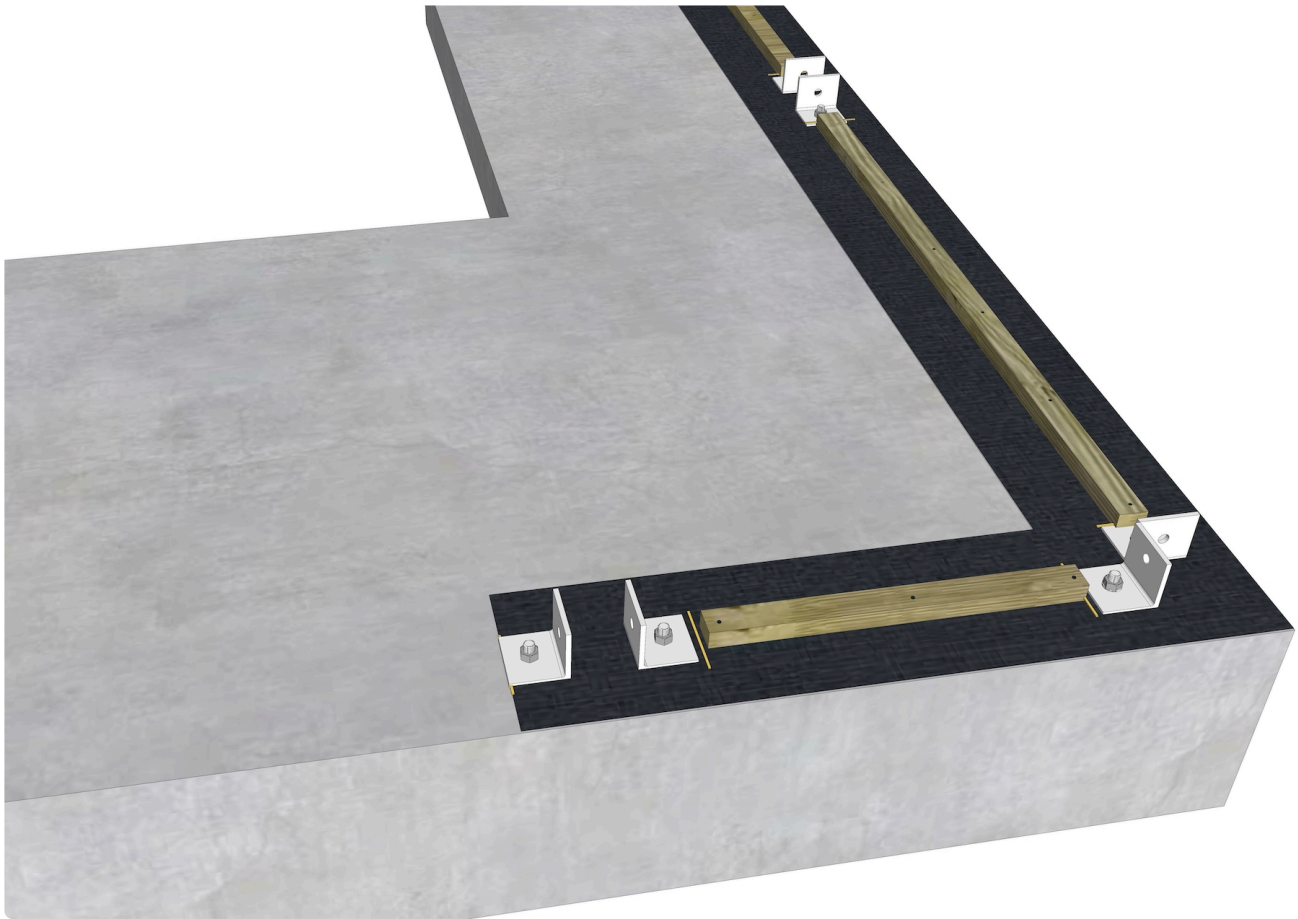

When the load bearing system is steel posts:



Fix the steel feet to the slab in line and plumb with packers.  
(use concrete screws or chemical anchor bolts as per engineering specifications)



## STEP 9

Tape the top of the steel feet up with a clear thin wide tape so no debris can fall into it, yet the post will pierce the tape when introduced from the top of the wall.

(use concrete screws or chem-set bolts as per engineering specifications)  
When using steel feet they need to be set in line and plumb with packers.

## 5.2. Wooden floor

---

### Preparing the floor surface.

To allow a bit more internal space, and to let rainwater runoff drop past the wall surface, the wall can be set max. **50mm** outwards of the substrate (floor) surface.

### Building a wall with LB 300 HempBLOCKs;

#### STAGE 1

The floor preparation.

*Attaching a tongue to the floor;*

Materials you can use: timber, FRP or mod wood

We can place the blocks straight on the floor after waterproofing the surface.

#### STEP 1

**Set out the wall position on the floor.**

1. Ensure the wall starts 250 mm of the general straight edge off the floor edge so the block overhangs the floor surface by 50mm. A chalk line is a clear and straight way of marking that line.

#### STEP 2

Waterproof the surface where the blocks will sit on the floor surface. Use standard waterproofing paint and if needed a primer on a clean and dry surface.

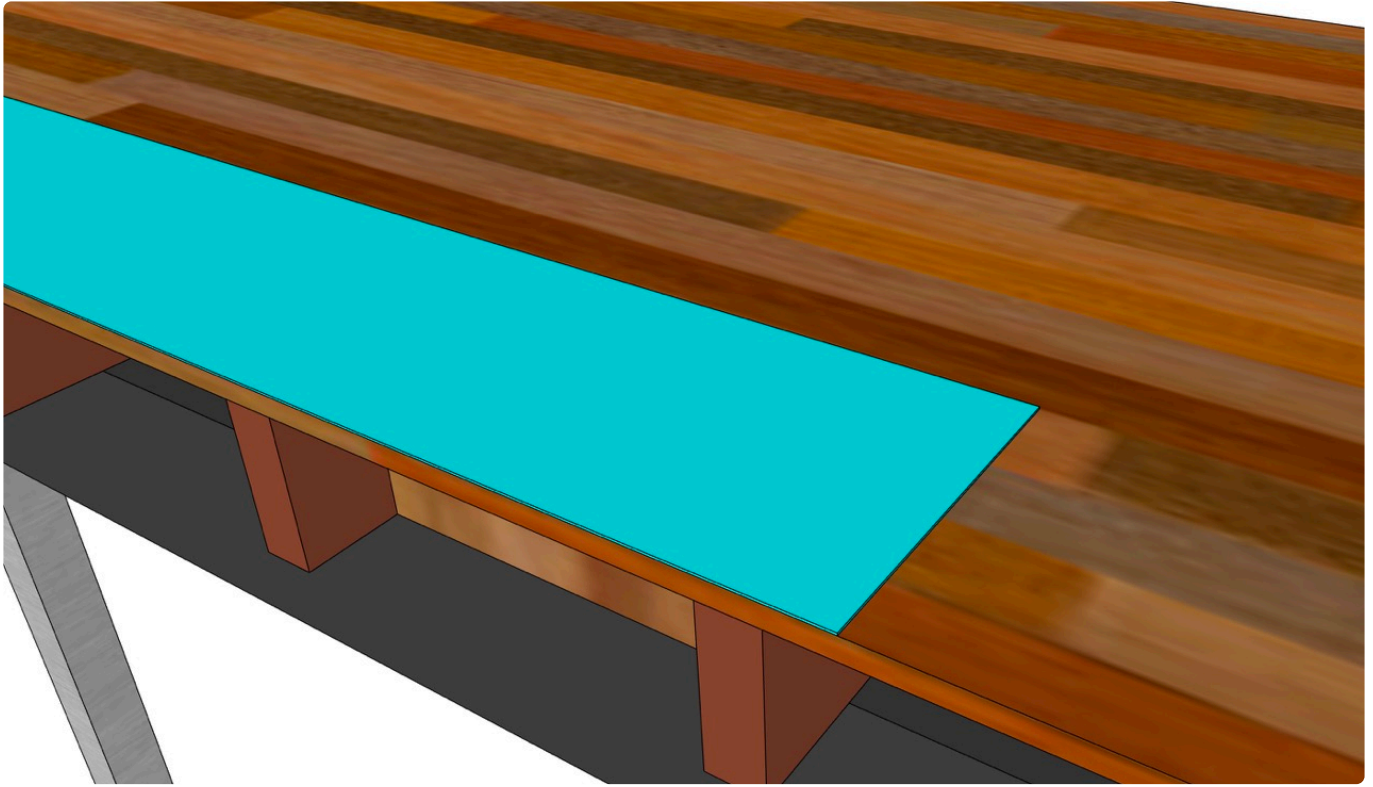
**STEP 3**

Apply a layer of damp course waterproofing membrane covering the surface where the blocks are positioned on the floor.

Use a sealant / adhesive on the outer sides of the floor to stick and seal the two membranes together.

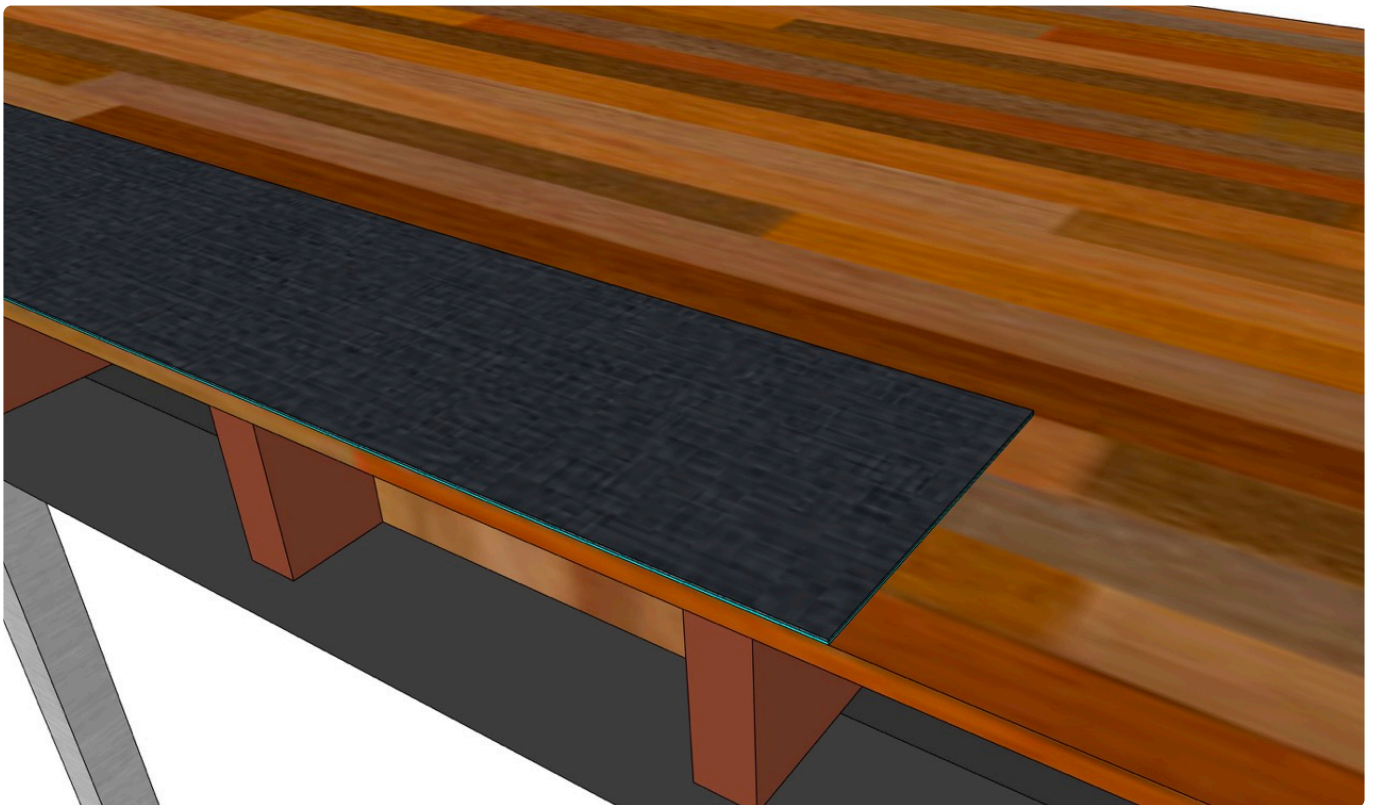
**STEP 4**

If building regulations require so get a termite specialist to install a termite barrier to local codes. This can be done in a variety of configurations depending on the material / system used. The termite barrier could also act as a damp course membrane at the same time.

### STEP 5

Mark out the thickness of tongue in the centre of the block. Minimal 35mm wide and 35 mm high. (Remember the block will sit 250mm in from the floor edge.)

### STEP 6

Fasten the tongue with regular intervals to secure to the floor surface. Use galvanised, treated or stainless steel screws or nails.

Exclude the spaces allocated for the load-bearing system.

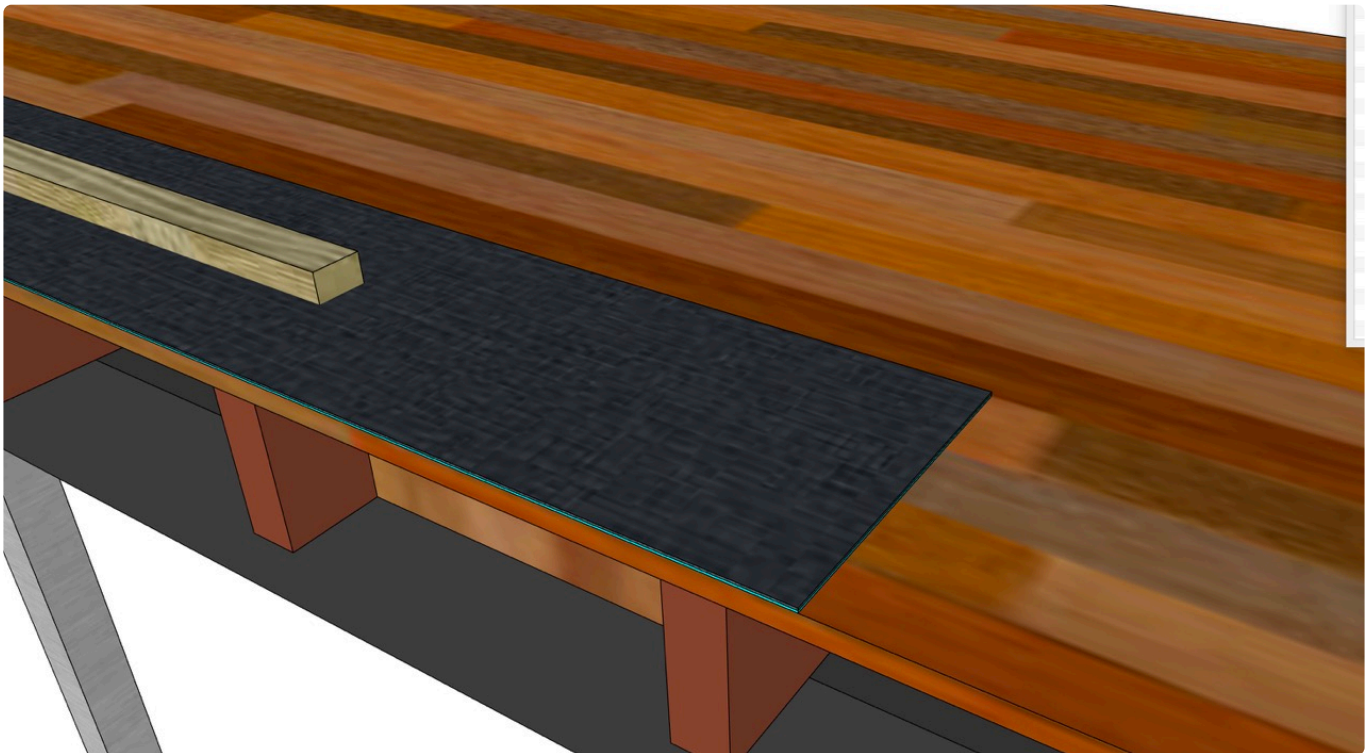

### STEP 7

When the load bearing system is FRP posts:

Affix the brackets that will connect with the steel or FRP posts or steel feet on the surface. (use concrete screws or chemical anchor bolts as per engineering specifications)

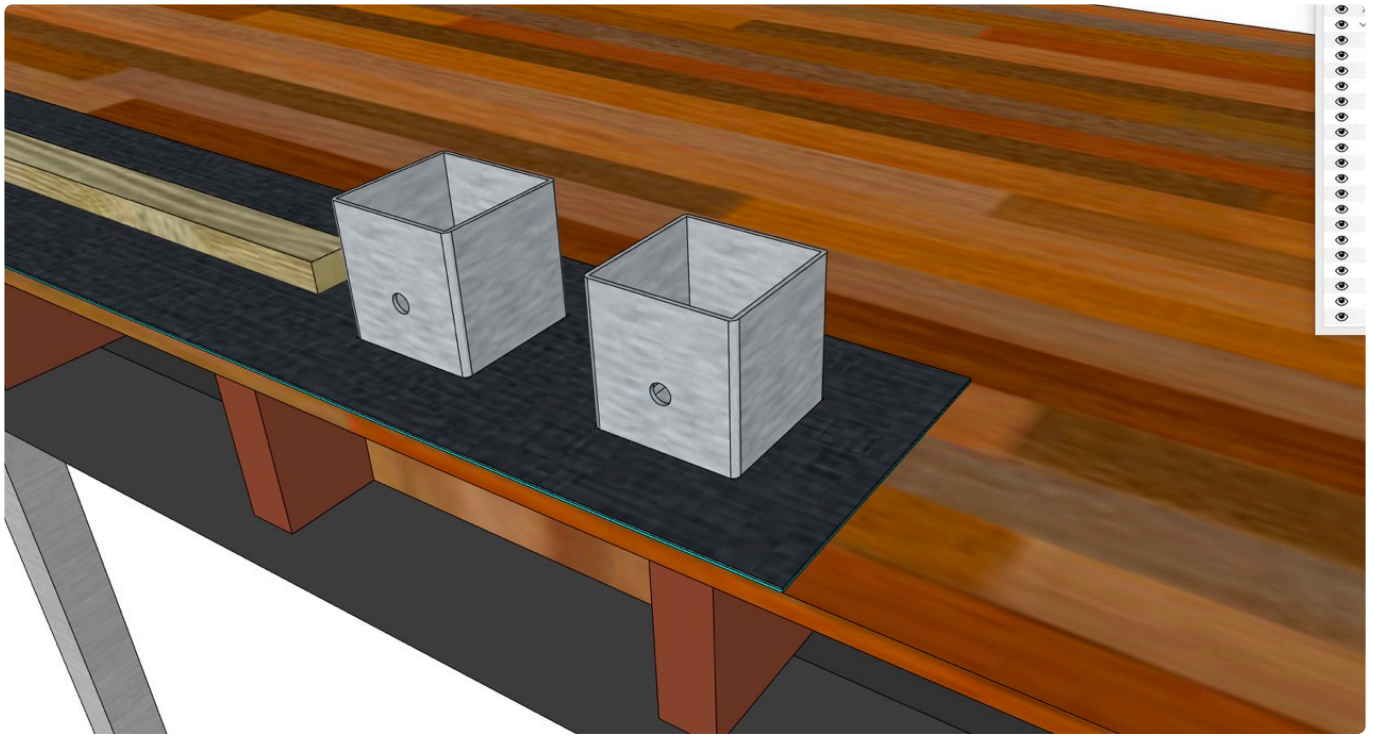

(No waterproofing installed in this example)

When the load bearing system is made of steel posts:

Fix the steel feet to the floor in line and plumb with packers.  
(use screws or bolts as per engineering specifications)

### **STEP 8**

Tape the top of the steel feet up with a clear thin wide tape so no debris can fall into it, yet the post will pears the tape when introduced from the top of the wall.

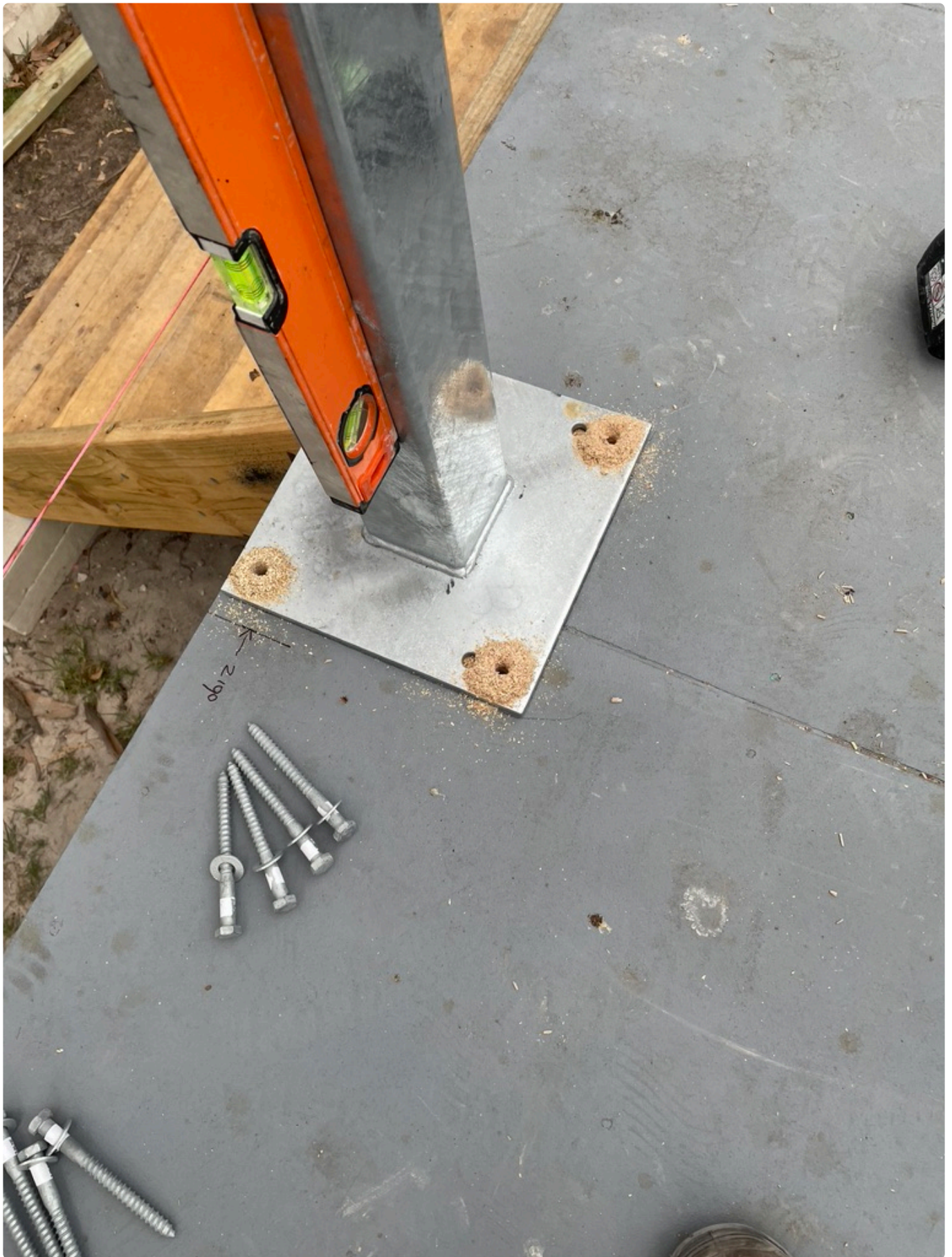





(the screws are connected to joists that are positioned under the floor)

## 6. 2 A Erecting walls with the Steel Reinforced Concrete load bearing system

### STAGE 2 A

#### Erecting the walls and the Steel Reinforced Concrete load bearing system

Now the start is made, all the load bearing brackets are attached and in the right place, waterproofing is done and termite barrier (if needed) is installed, we can commence laying blocks. Use the 3D model to assure you have the right positioning of the walls.

Refer to the chapter [safety](#) and [tools](#) where we run through block placing, [handling and cutting](#) before starting to lay the blocks.

### STEP 1

When using a tongue and creating a groove in the first layer of HempBLOCKs;

Cut the tongues of the first blocks and create a groove that accommodates the tongue size. Keep the width as accurate as possible, but allowing a bit more for the dept of the groove.

You can use a wall chaser, angle grinder or chain saw.

See topic [tools](#).

### STEP 2



#### Note:

Start laying blocks with two corners and its wall in between. The aim to work to the stage so you have completed one wall and two corners. This way you can secure the load bearing system, and fill the void between the system and the block with the perlite / cement mix.

This will make this wall resistant to wind-loads that may occur during construction.

#### When placing the first layer of blocks on concrete starter blocks;

Place the first layer of blocks in the right position with the tongue in the groove when using starter blocks.

#### When placing the first layer of blocks on a tongue;

Place the first layer of blocks in the right position with the groove on top of the tongue.

### STEP 3

Now you know where the wall should be situated, you could install what we call brickies stays with string lines, or after three rows high attache a true post into the corner.

**STEP 4**

Cut a groove in the part that connects with the next block to receive the tongue of the block placed on top.

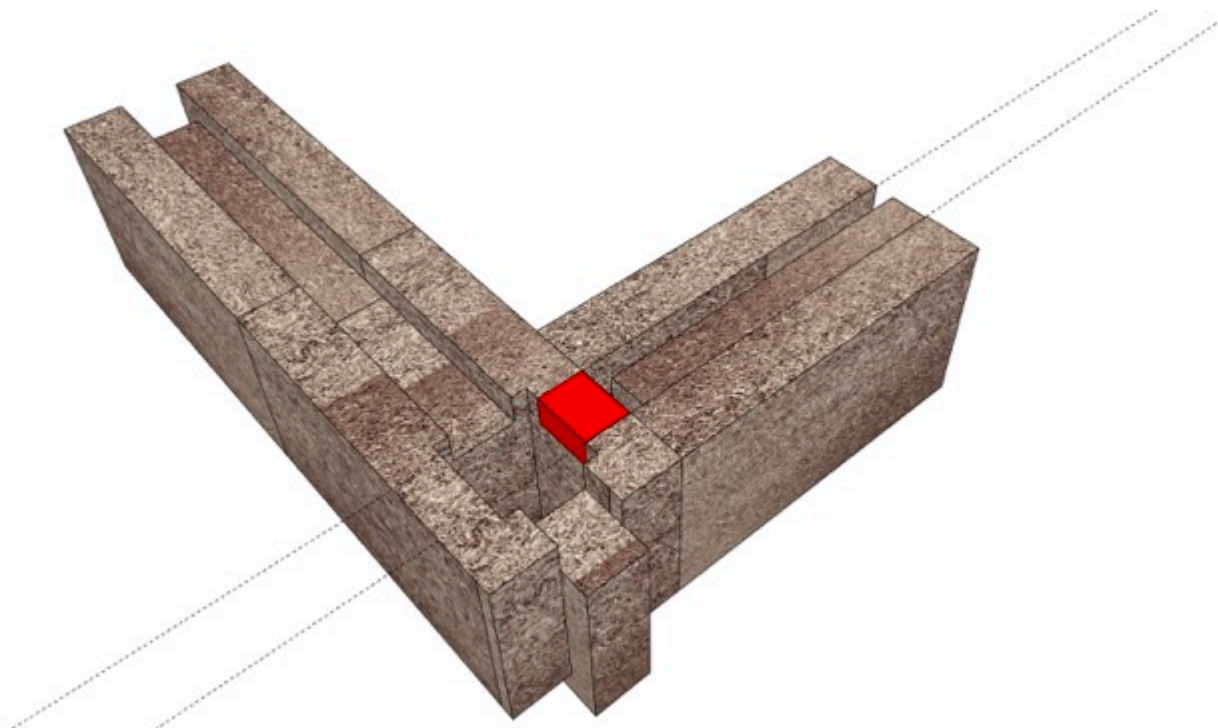
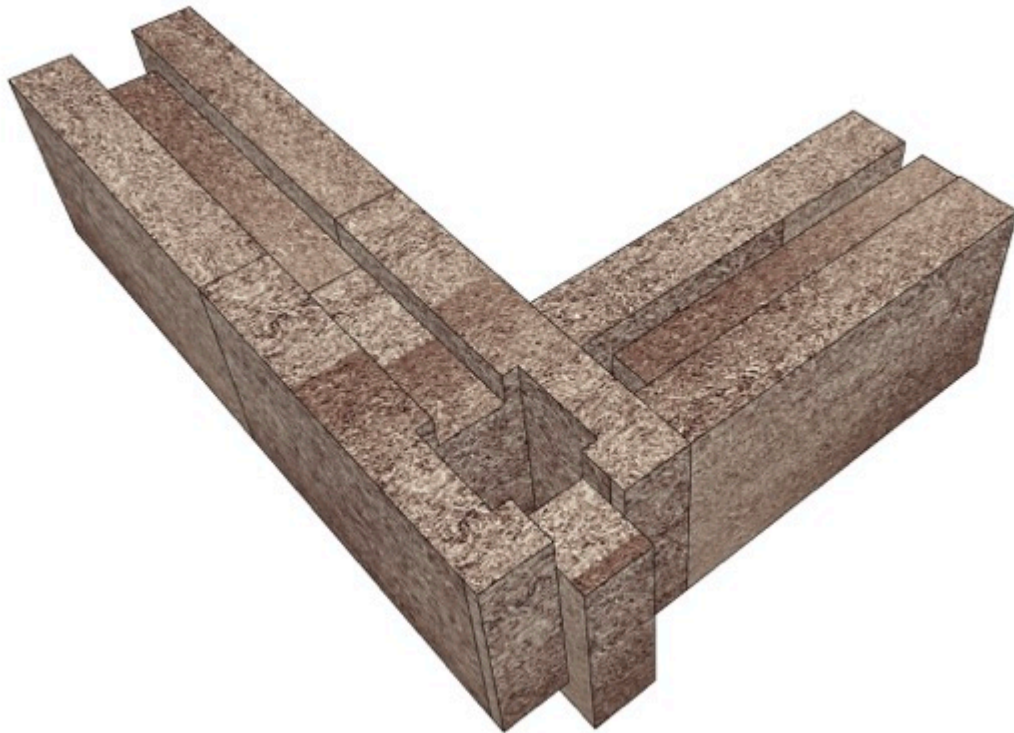

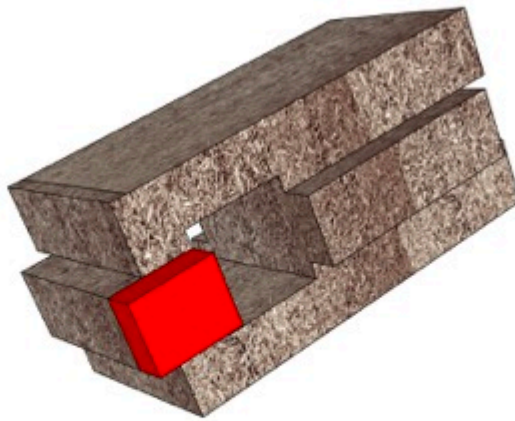
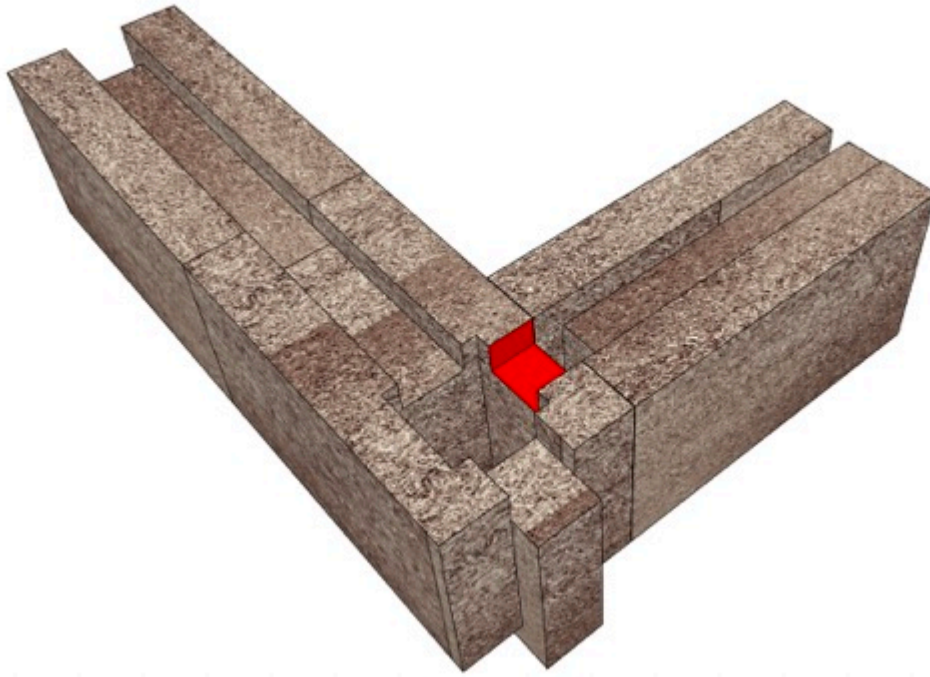

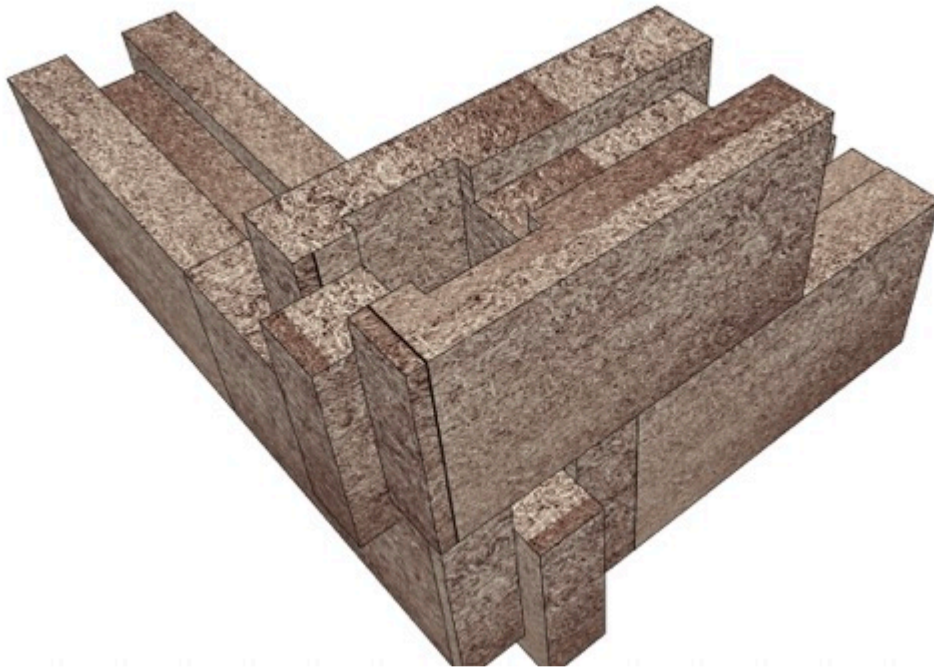

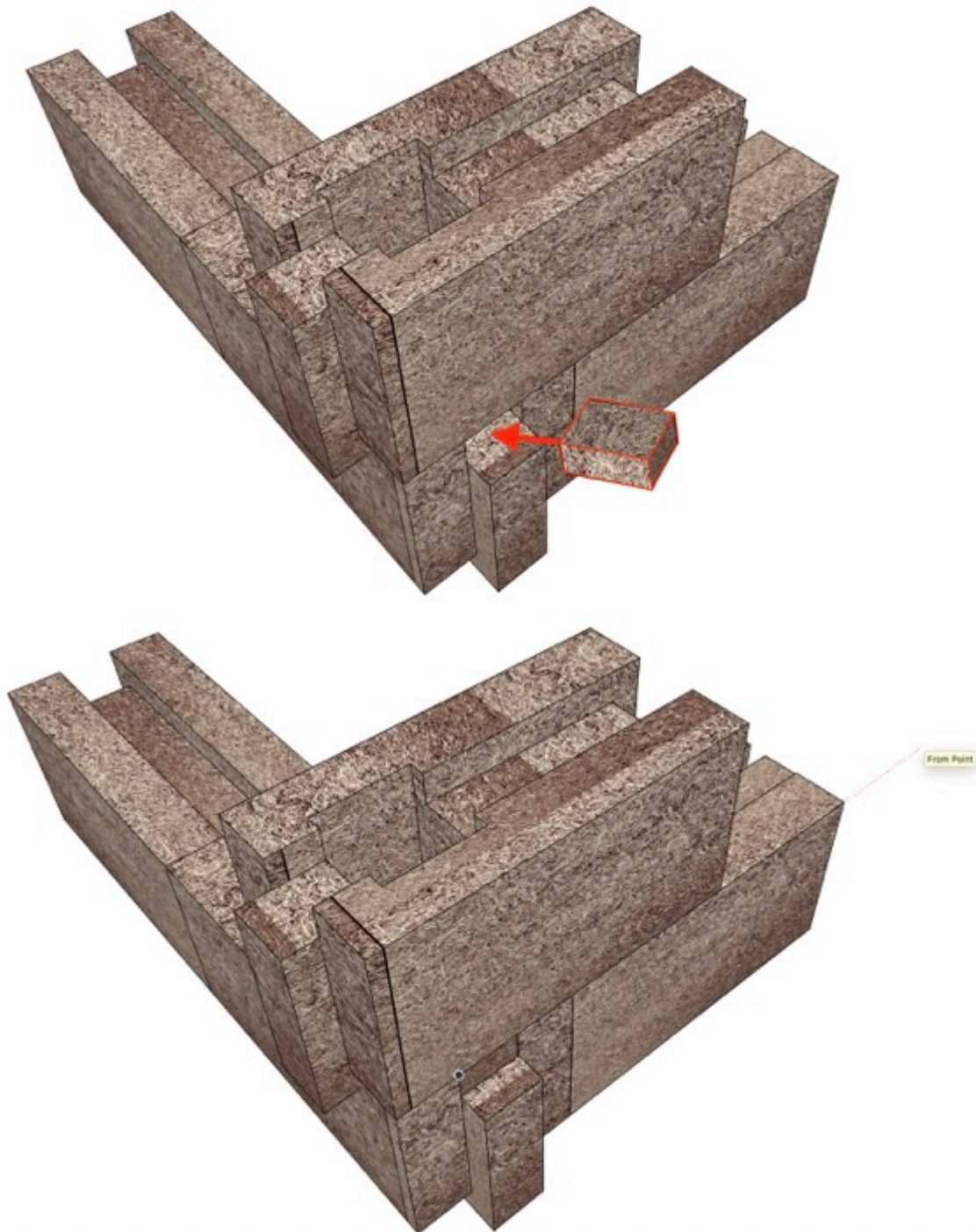

The general gist is to adapt the blocks so the interlocking system is used as much as possible. Lay the second layer in a staggered fashion at all times. This is called a *stretching bond* where the block on top of the bottom one is centred over the end of the lower block.

For the column blocks:

The voids in the column blocks need to align as perfect as possible so the vertical void lines up and is plum and straight.

In general the blocks interlock at the top and bottom as much as possible blocks on each side.

[Air blow](#) the connecting surfaces (top and bottom of the next block) before interlocking them together.

It is handy to create '[banger plates](#)' so the surface you hammer on connects with the full surface of the

block.

See [Tools](#)

Go around the perimeter of the building. And continue with the corners of the wall you aim to finalise first.

See a short video [here](#)

When a block is butted (not a tongue and groove connection) fill the vertical groove void between the blocks with the off-cut of the tongue.

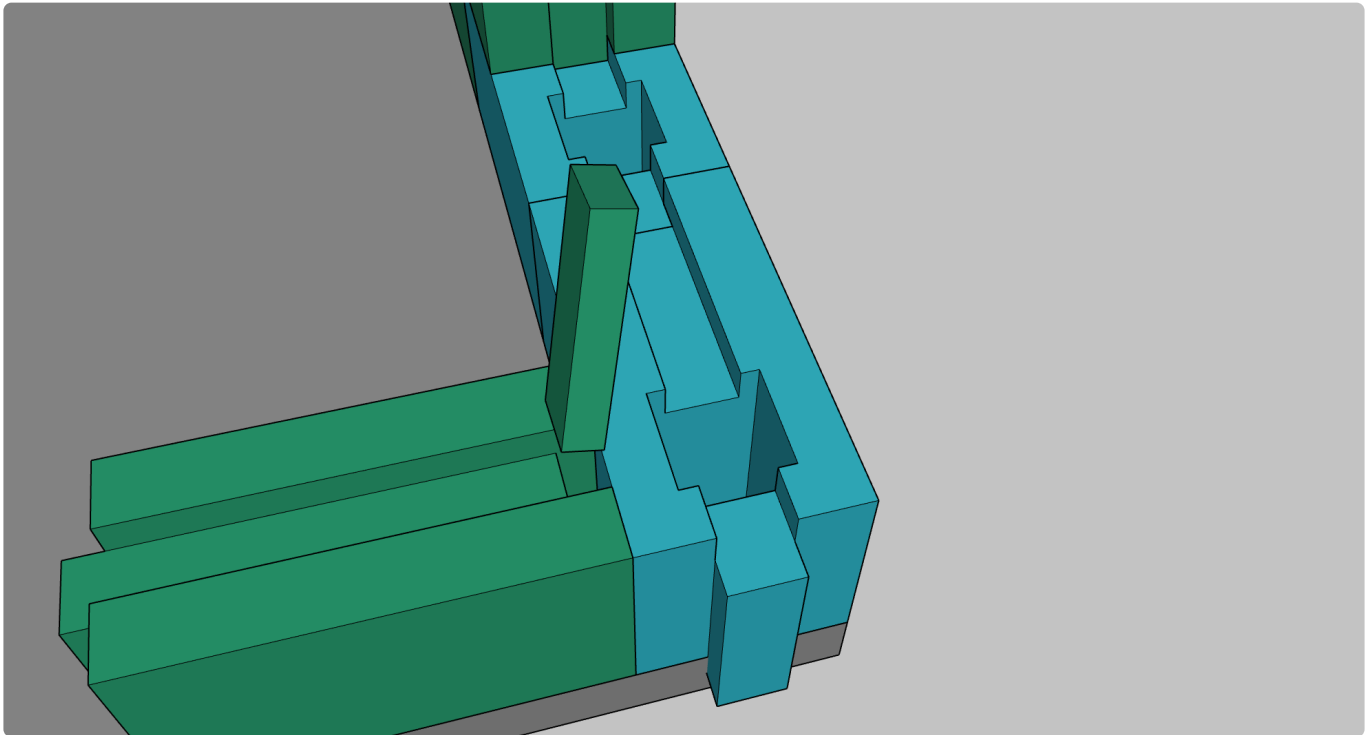

## STEP 5



### Note:

As the wall is build, the walls will slightly shift out of plumb because interlocking the blocks moves them. Check the 3 axes of the walls regularly. **Level** line, **plumb** and **vertical** so your blocks don't tilt in our out.

It is recommended to start with a corner, and keep that corner plumb.

!!! On the corners, plumb is measured from the side of the blocks, past the heads of the underlaying block. Never the male side! The male sides of the blocks are slightly irregular.

Use of a plumb blob is recommended.!!!

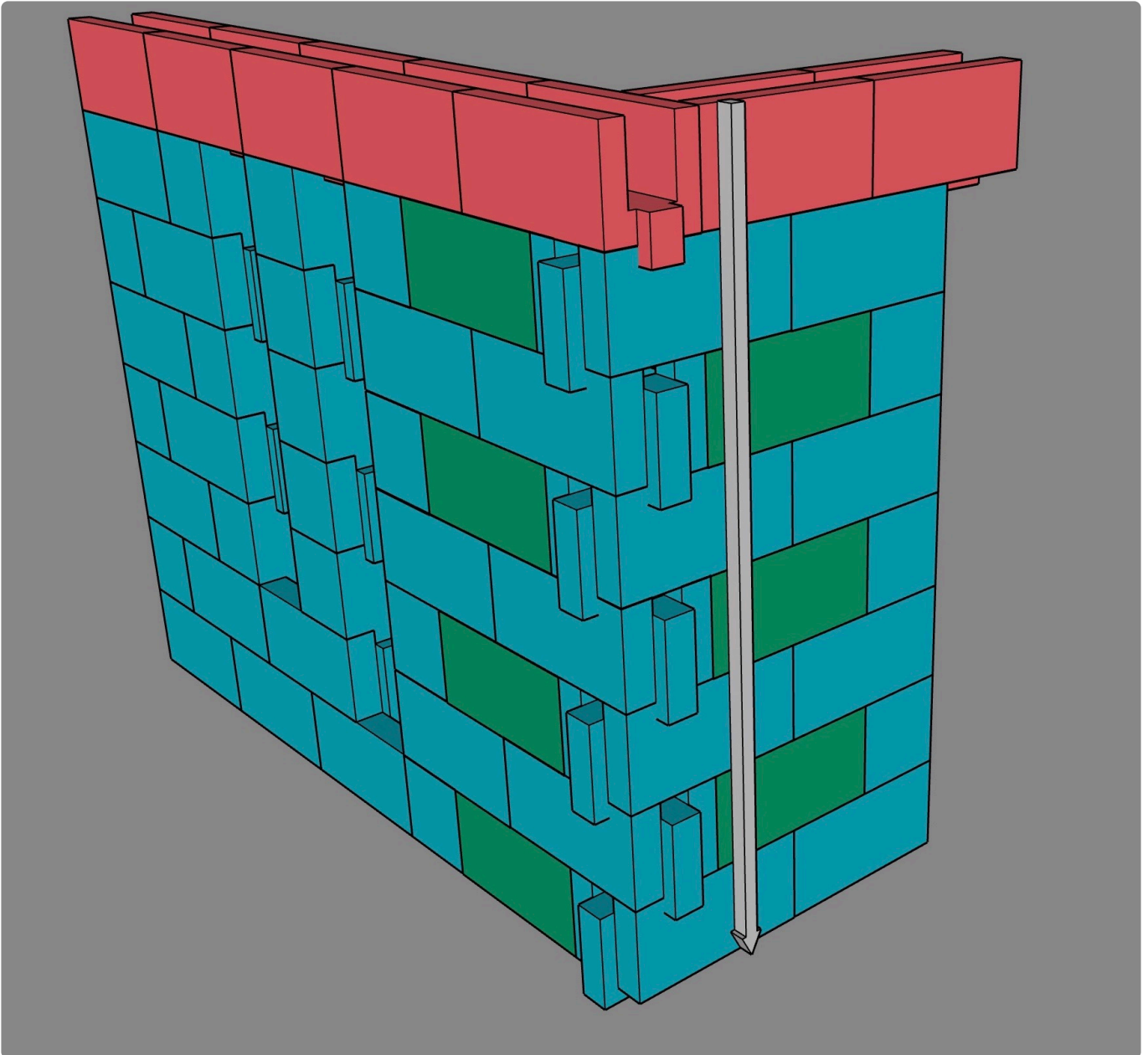

Use packers or shave high spots where needed.



Note:

Keep safe! Best to have some struts in place on long walls and lintels to ensure blast winds don't push them over before they are reinforced.





[Building HempBLOCK walls 1](#)

[Building HempBLOCK walls 2](#)

**STEP 6**

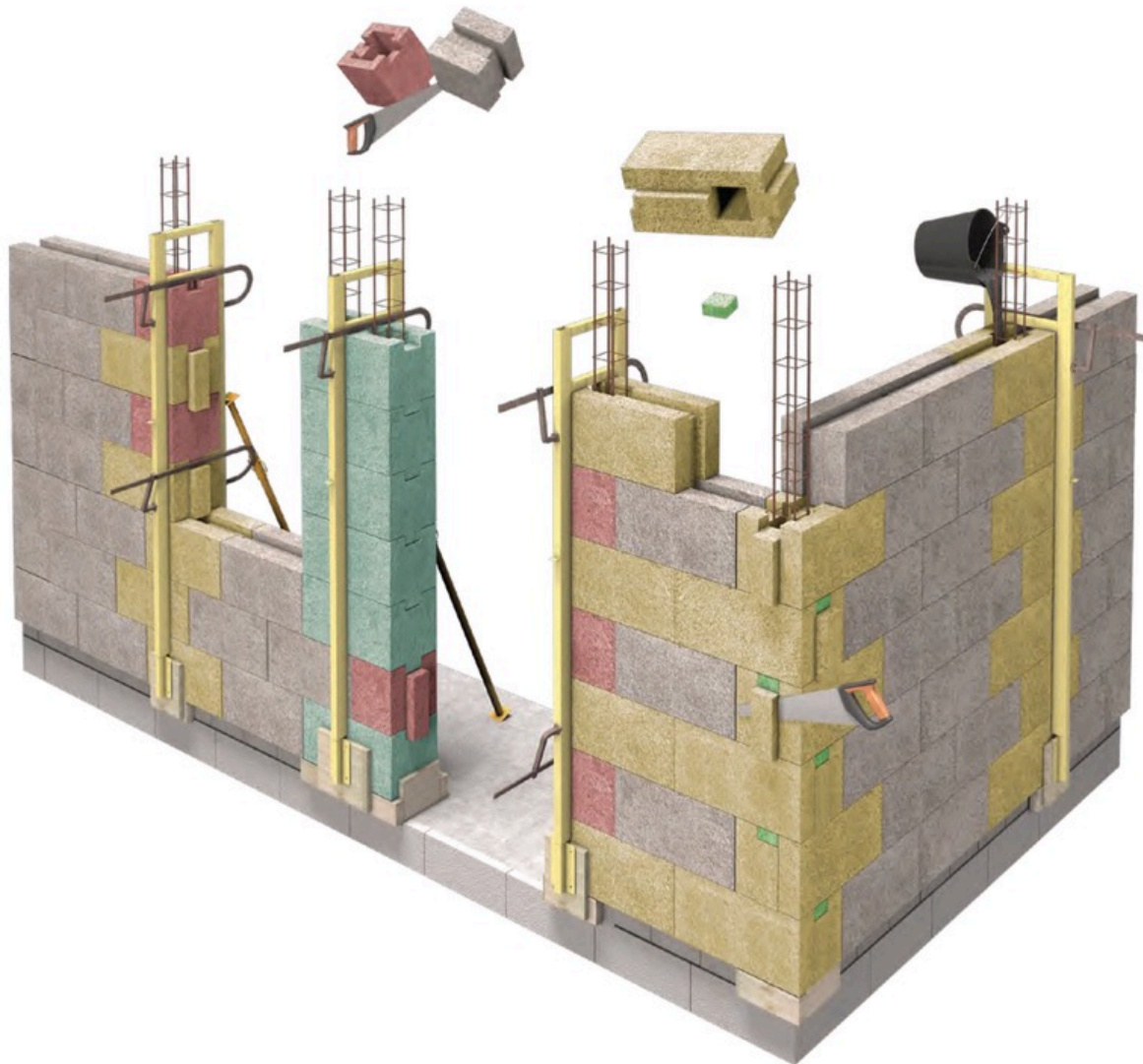

When you reach lintel or header height, you need to get the infrastructure for the load bearing system ready before continuing with laying blocks.

**WITH A STEEL REINFORCED CONCRETE SYSTEM;**

The cages for the columns on either side of the window or door opening are cut to (ring beam) height and introduced into the void of the column blocks.



You can use punctual rebar spacers (image) to keep an equal distance between the HempBLOCK cavity wall and the rebar cage.

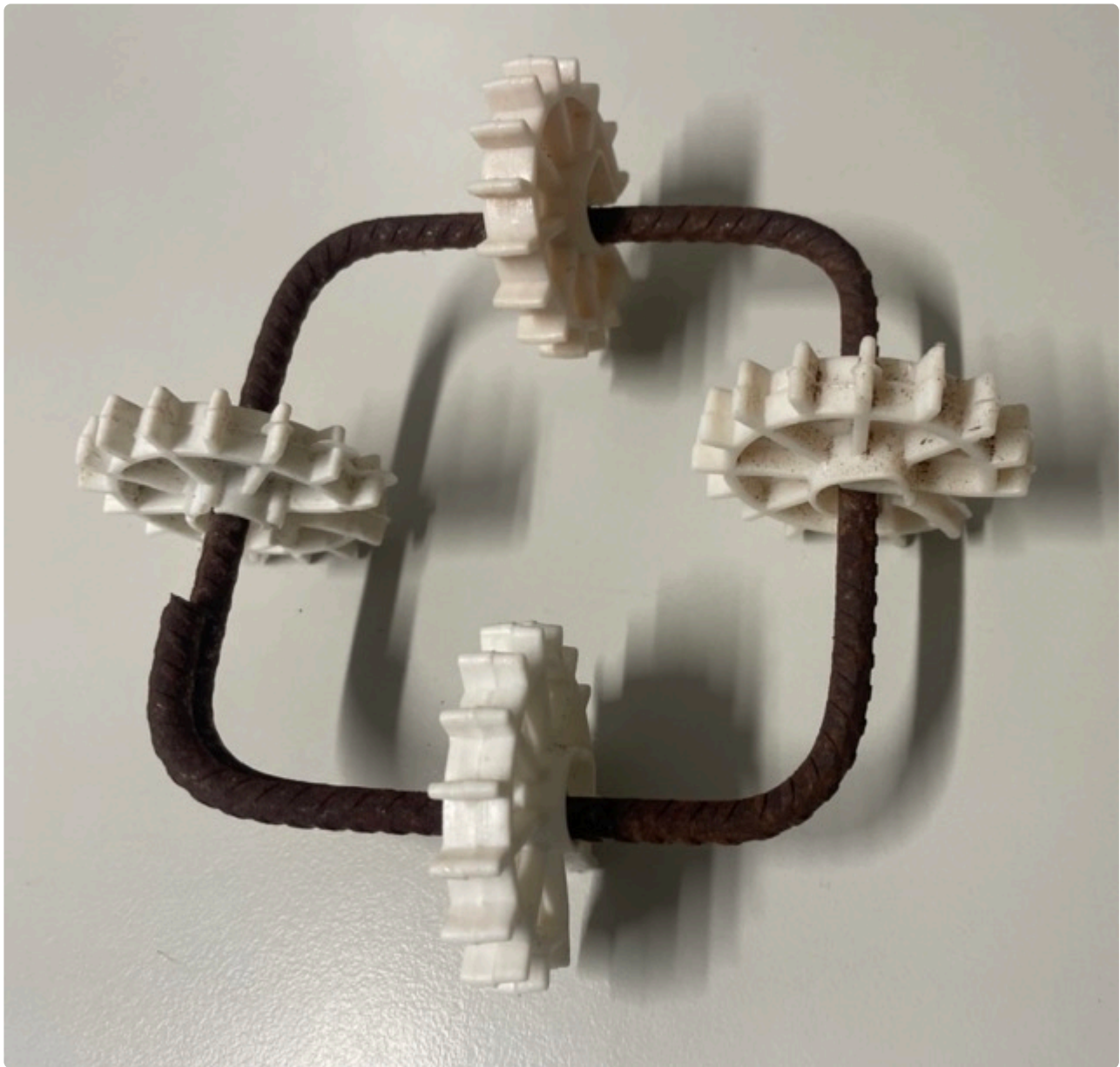

## STEP 7

The lintel supports are put in place and held while the lintel blocks are positioned on it. Aluminium, or steel brackets, timber or steel supports can be used in combination with props that are properly secured to the brackets or supports.



Here with a rented expandable header support.

### **STEP 8**

Wax or oil the steel supports so the infill material does not bond to the steel surfaces.

You can also use packing tape and wax or oil it as it does not bind to the perlite or concrete infill.





**Timber lintel block supports.**



### **Aluminium lintel block supports.**

Secure the stays so they are solid and can not fall to avoid injury and damage.

### **STEP 9**

Position the U blocks preferable with at least 70mm support onto the corner column block. The first and last U block might need to have a 150 × 150 mm hole cut in it if they overlap the column hole.



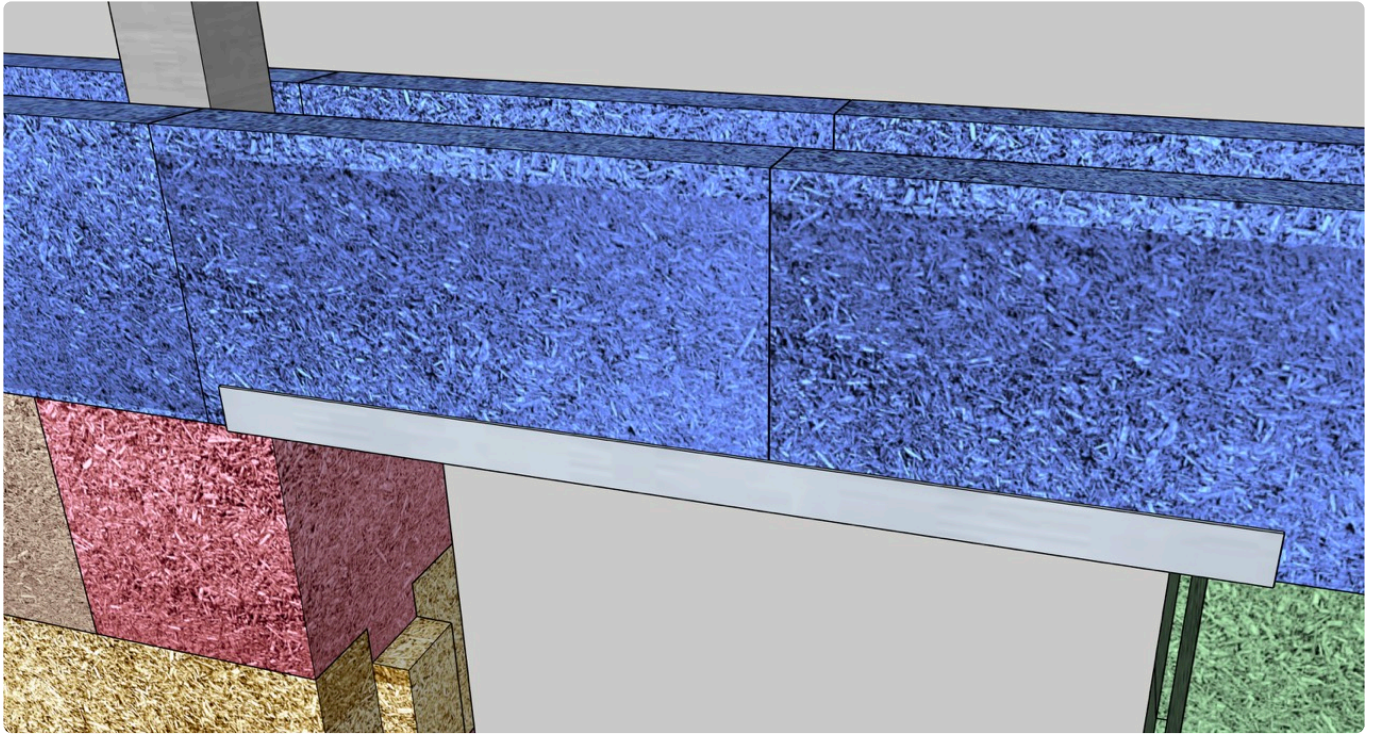

The first and last U block might need to [cut a hole](#) if they overlap the column hole.

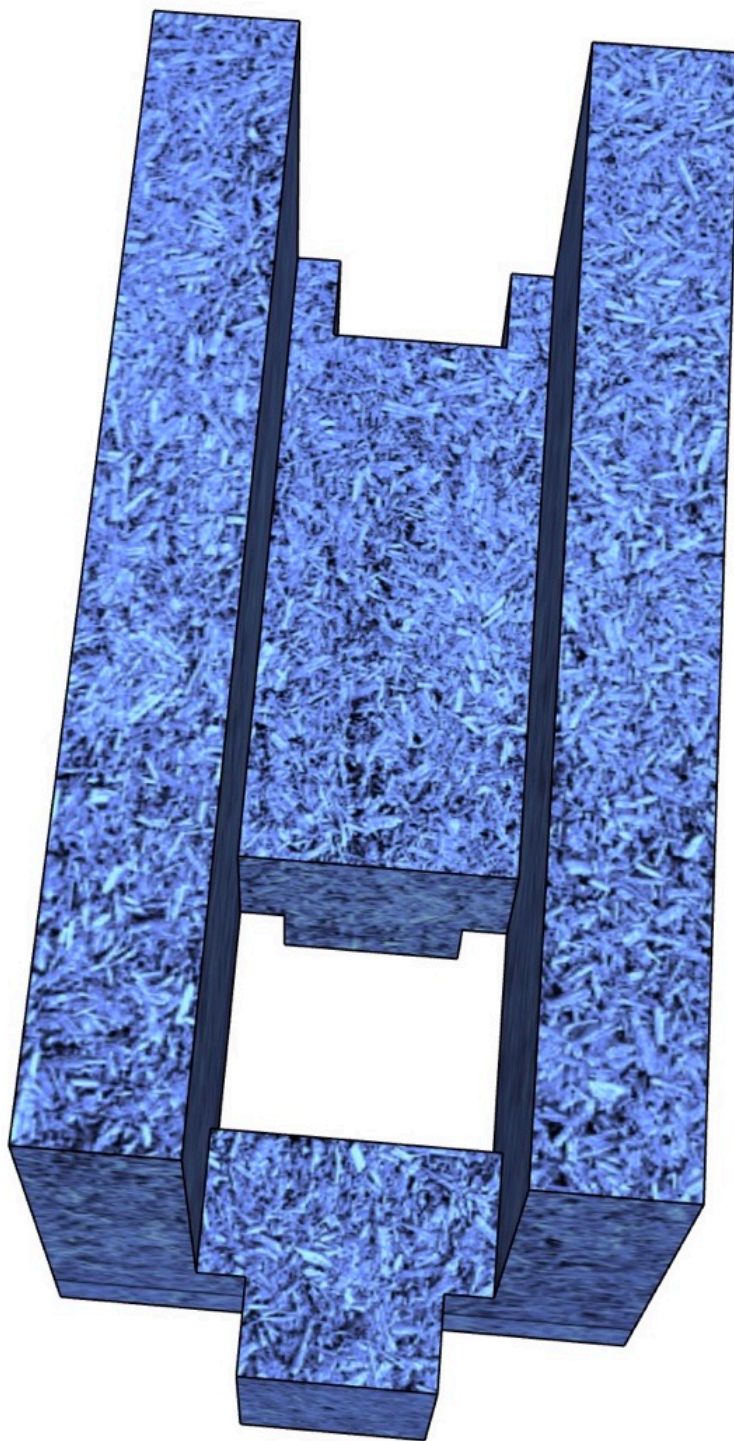
**STEP 10**

Here some details of the steel rebar connections. The steel sizing will vary depending on engineering specifications.

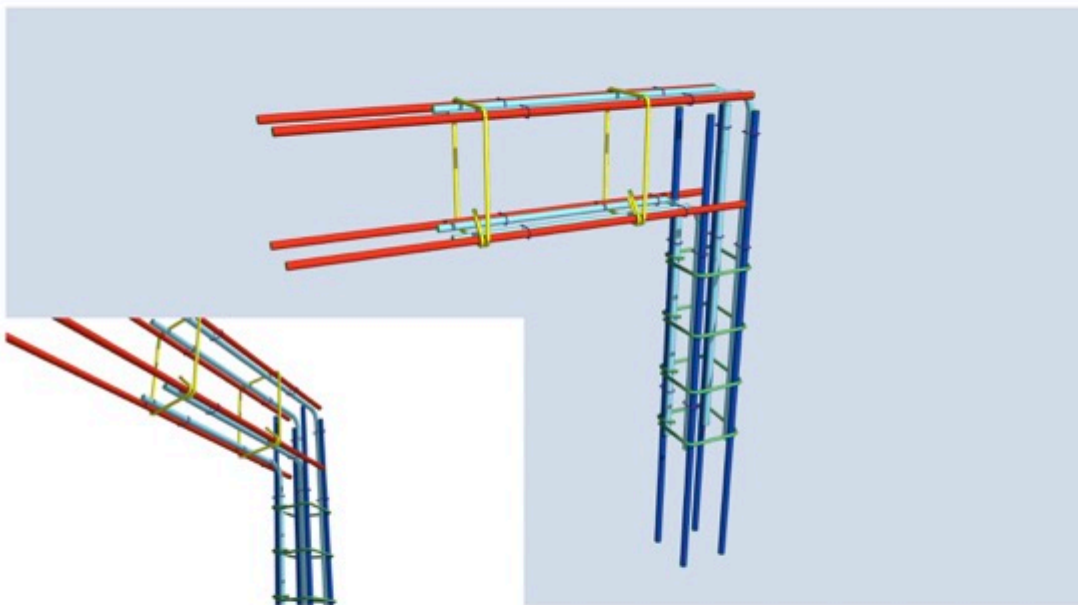
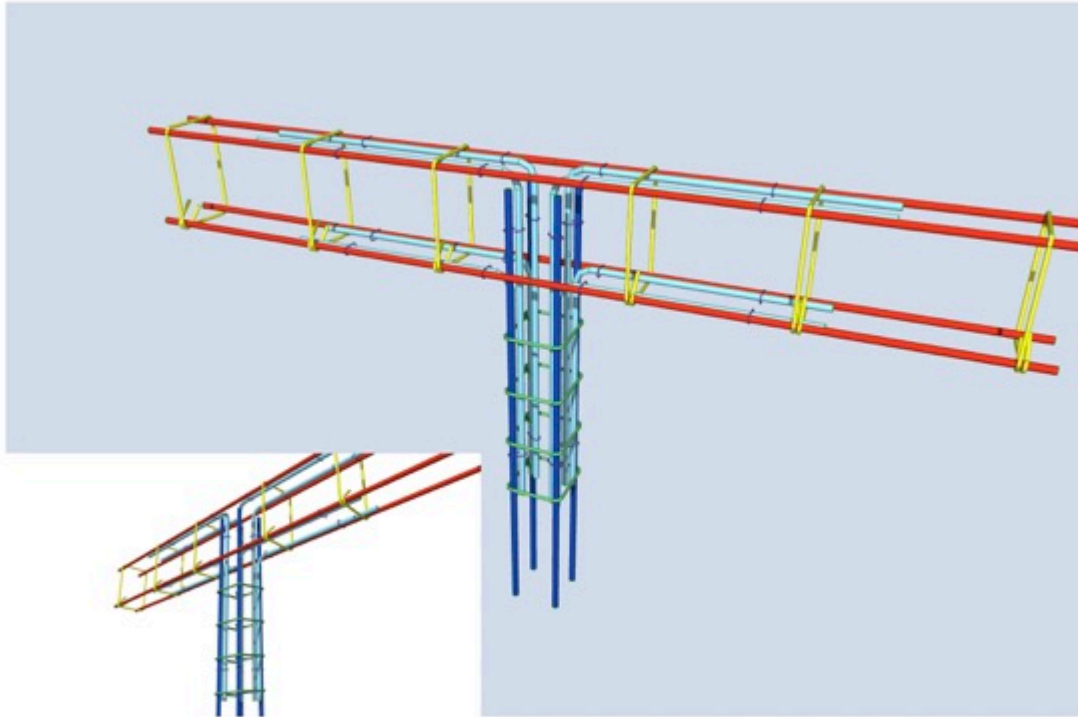

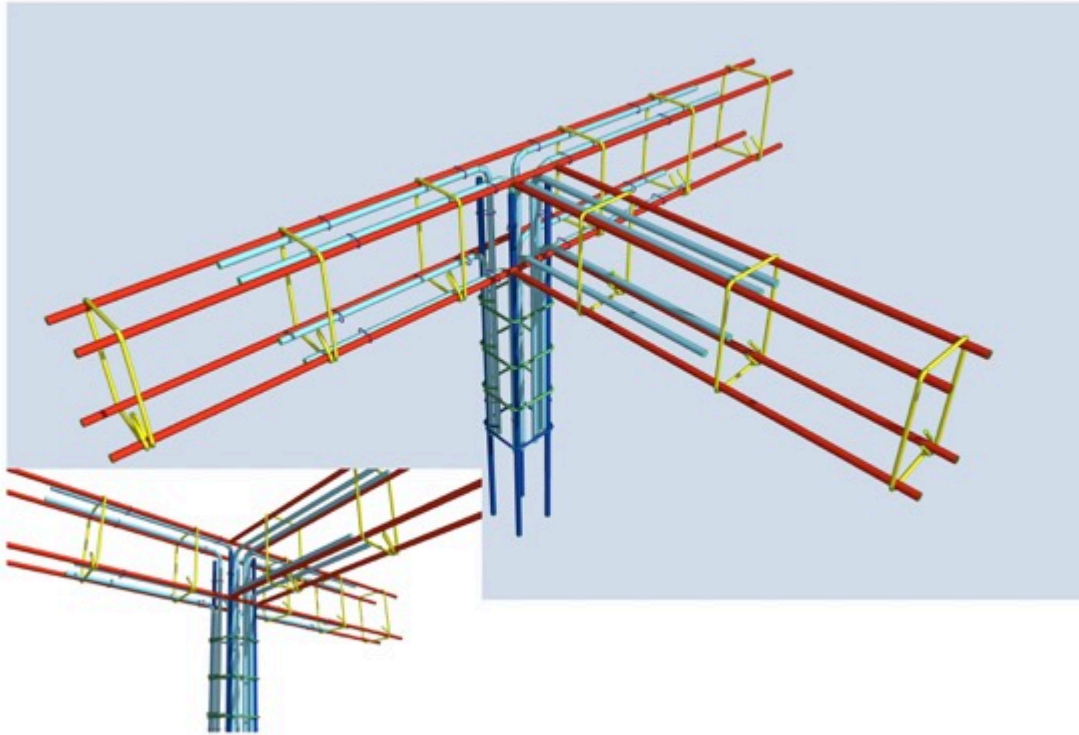

With the lintel blocks in place, connect the steel cages to the columns with steel ties as per engineers specifications.

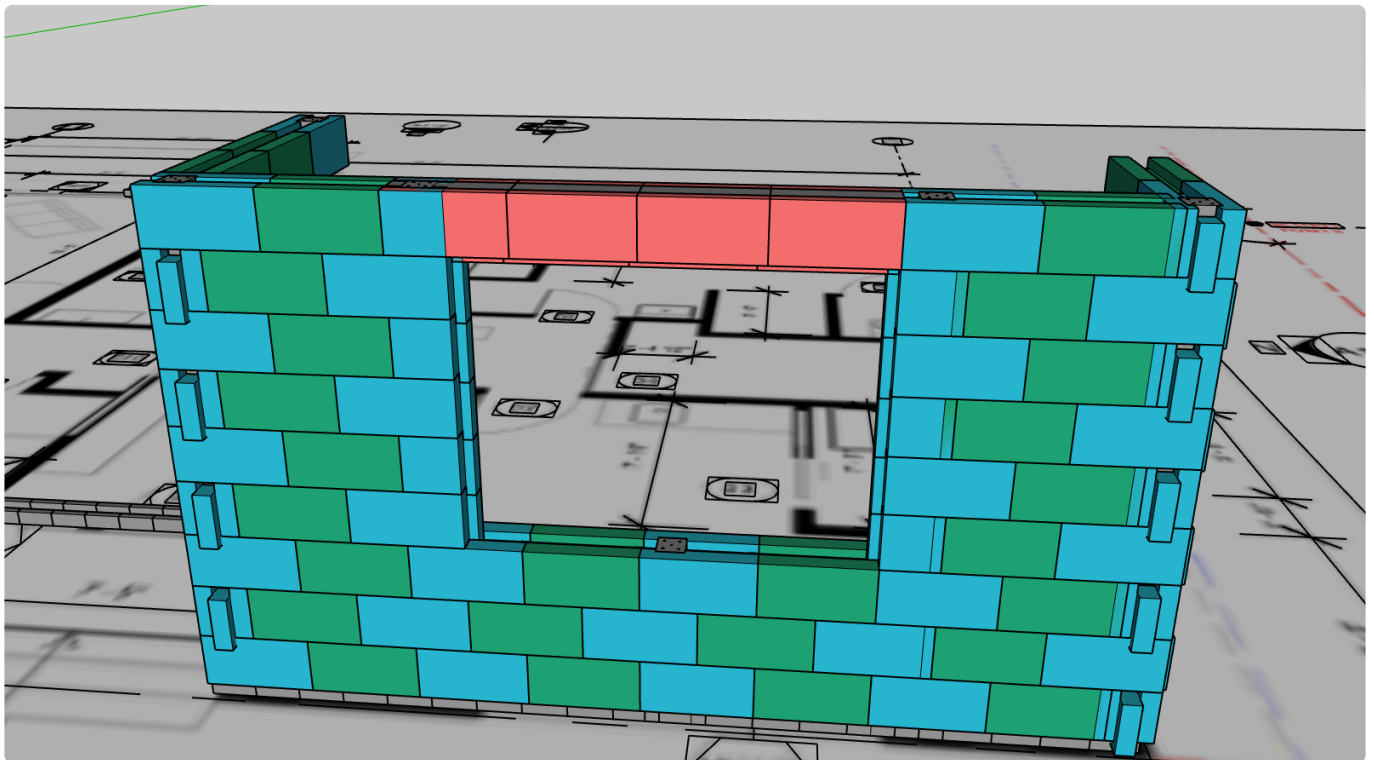

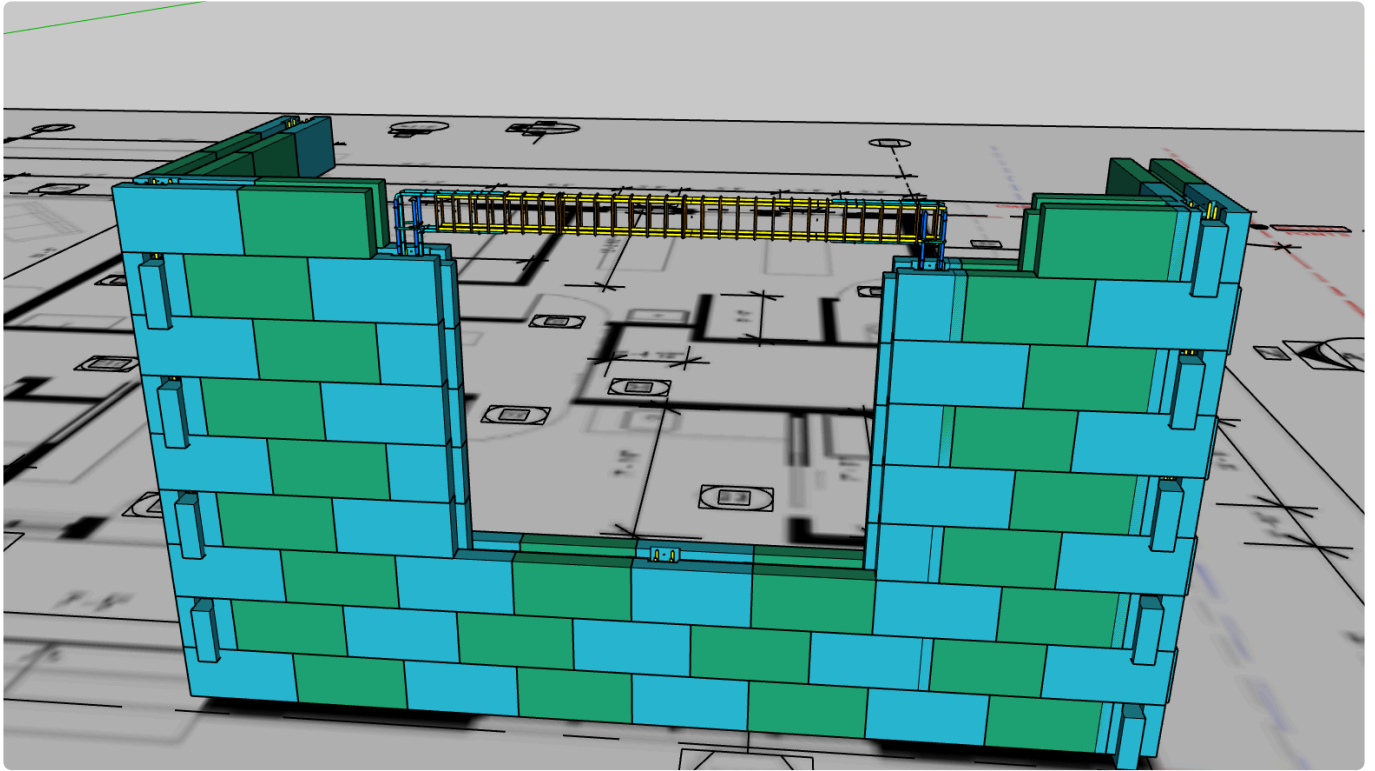

Here demonstrated without blocks

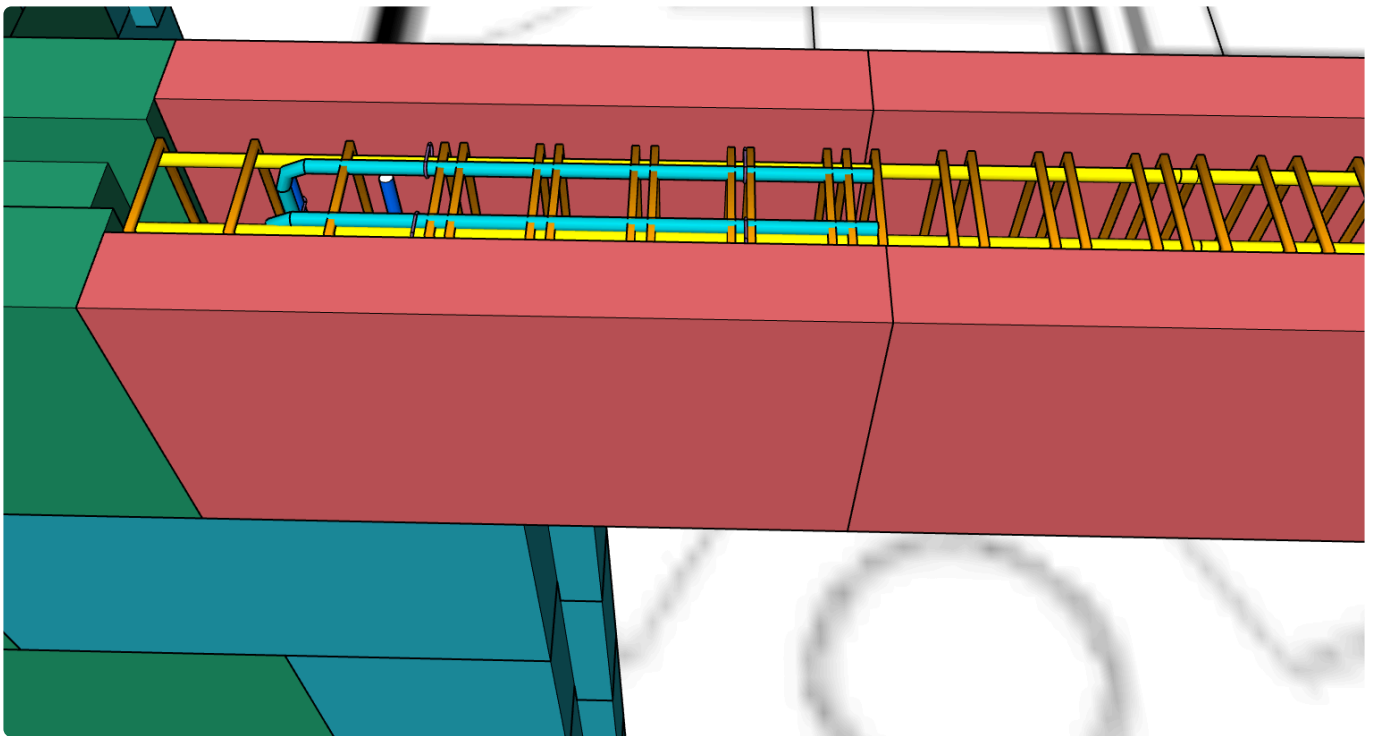

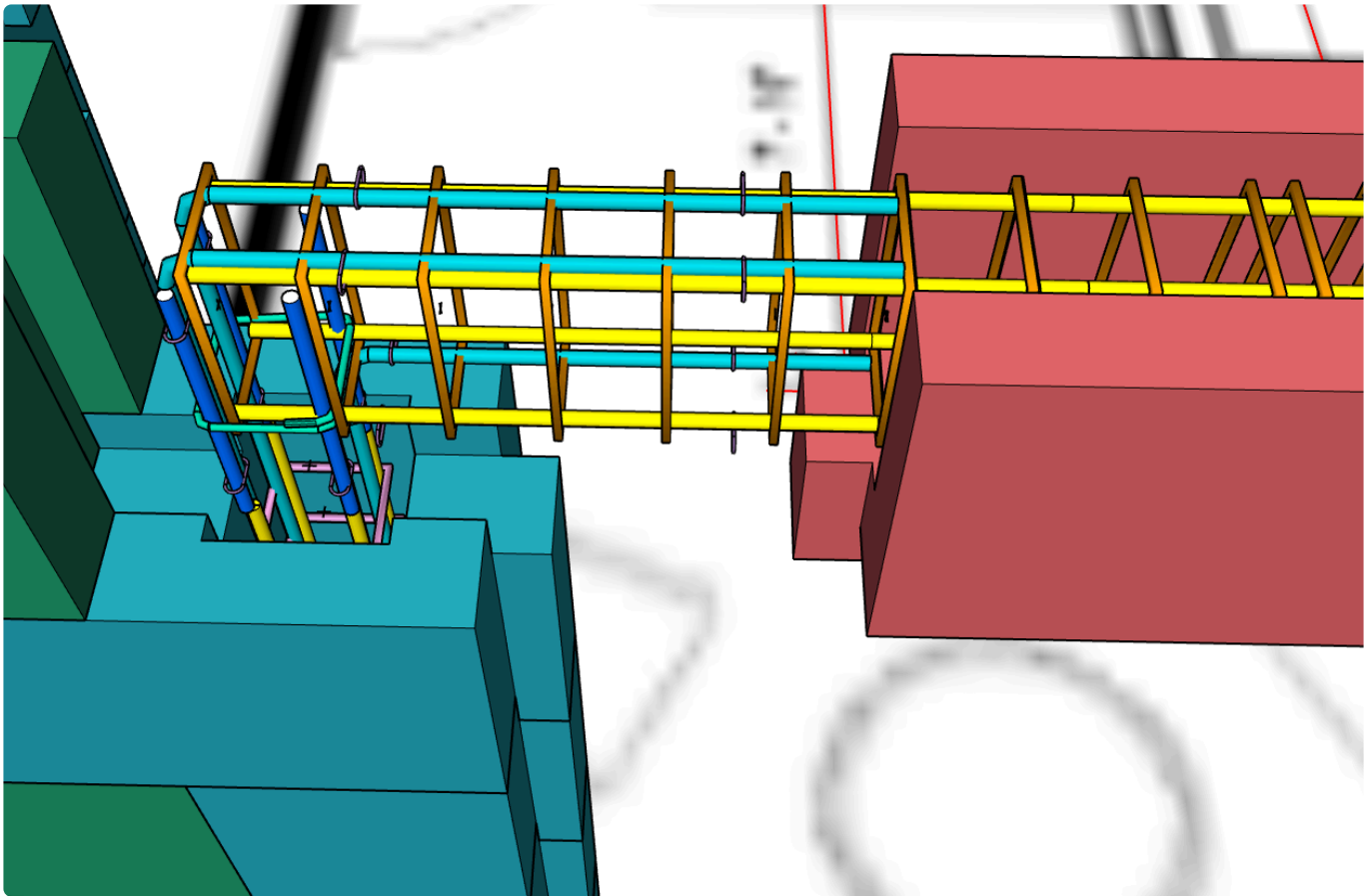

Here we show the steel connection between the column and lintel cage. For clarity we left out the first U block.

\*Here a video of the steel inside a ring beam before casting the concrete. \*



<https://www.youtube.com/embed/q0jCh22louo?rel=0>

#### **STEP 11**

To have access to the starter bars, cut a hole in the bottom column blocks.

This is not needed when starter blocks are used as the first layer is raised from the floor.

#### **STEP 12**

Use wire to attach the column cage to the starter bars. Assure the rebar cage is not touching the sides of the column blocks.

Follow engineering specifications.

[Here](#) a video of the preparation before pouring concrete}



[https://www.youtube.com/embed/xMS7ADgHW\\_o?rel=0](https://www.youtube.com/embed/xMS7ADgHW_o?rel=0)

Before filling the columns and lintels / headers with concrete, all columns, corners, U blocks need to be appropriately boxed and formed up.

Use clamps, braces, wire, screws or custom made blocks to secure the sides of the U blocks.

#### **STEP 12**

Remove all rubble and debris with an [air blower](#).

#### **STEP 13**





Block the holes in the bottom column blocks and where holes have been made to connect the lintels / headers with the columns on both sides so the concrete does not flow out.  
We use timber planks or ply and roofing screws to keep them temporarily in place.



#### **STEP 14**

Go around the walls and fill in other voids with either;

- hempcrete or a
- hempcrete/perlite mix
- lime mortar
- expandable foam

Pay attention to the gaps between the U blocks used to create the lintel / header. Concrete or the perlite mix will pour through it if not blocked off.

#### **STEP 15**

Brace and plumb the walls.



<https://www.youtube.com/embed/EZWAbn6phSs?rel=0>

## STEP 16

Before casting the concrete infill of columns, lintels / headers and bond beams go through this check list;

1. check if all reinforcing is correctly attached. Make pictures for your engineer if needed.
2. have the engineer or certifier check your work if required
3. check if your walls are straight
4. check all walls are plumb
5. check if all columns and lintel blocks / headers are reinforced are connected properly and centre to the blocks
6. check if all holes are filled or blocked up. Boxing of the lower end of the walls needs to be strongest as the wet concrete will create a lot of pressure on these parts
7. assure you can go around the walls to be filled with planks and safe platforms
8. check the composition, strength (see engineering specifications), retarder and slump of your concrete. This is the most critical part of the pouring, too wet, not setting fast enough and too small or too big aggregate are essential to get right.



### NOTE:

Standard concrete specifications – check with your engineer -

- \*Aggregate:

- Slump:
- Strength:\*

A concrete pump is preferred for bigger projects so there are no cold joints created in the concrete fill.

## STEP 17

Depending on weather / humidity and wetness / slump of the concrete, you can gently spray the gages with a water mist for the concrete to flow down easily.

Do not soak the blocks.

Don't pour when the blocks are still wet from excessive rain.

Pour the concrete in the column voids at 3 feet / 900 mm increments.

Pour the sills.

Go around the perimeter of the walls until to the height of the first stage.

### DO NOT FIBRATE

You can poke gently with a rod for the concrete to flow down past the cages, *but pay attention !!!!!, this may cause blow outs.*

It is preferable that the concrete has the right slump.

Check for blow outs.

When reaching the bond beam and lintel / header, fill it and screed the top off.

### Method Sloping wall:

## STEP 18

After the concrete has set and hardened over two days, continue with laying the wall and work up to the final stage.

Here we place the lintel blocks or create the gables.

Over a lintel / header you have to cut the tongue of the next blocks. You can use a lime based mortar or thick glue like 'Liquid nails' or a cement based glue that does not have any thickness to it, to adhere the blocks to each other.

Standard, there is non or only one more layer to go on top of the lintel / header.

This will then be your ring beam.

[Cut the 150 × 150 mm hole](#) or groove to lift the blocks over the post where needed.

See chapter cutting HempBLOCKs.

## STEP 19

Prepare the ring beams / cages.

In timber or FRP case you may need to attach the Burmon brackets in advance and loop a steel strip

around them to the beam.

## STEP 20

Place the U or lintel blocks.

In case of a sloping wall see **STEP 23**

## STEP 21

Connect the steel of the top plate to the column steel as per engineering specifications.

## STEP 22

Repeat **STEP 16**

## STEP 23

Cast the concrete.  
Screed the top of flat.  
Take the boxing off.

## STEP 24

### Method Sloping wall:

There are a few ways to create a sloping wall.

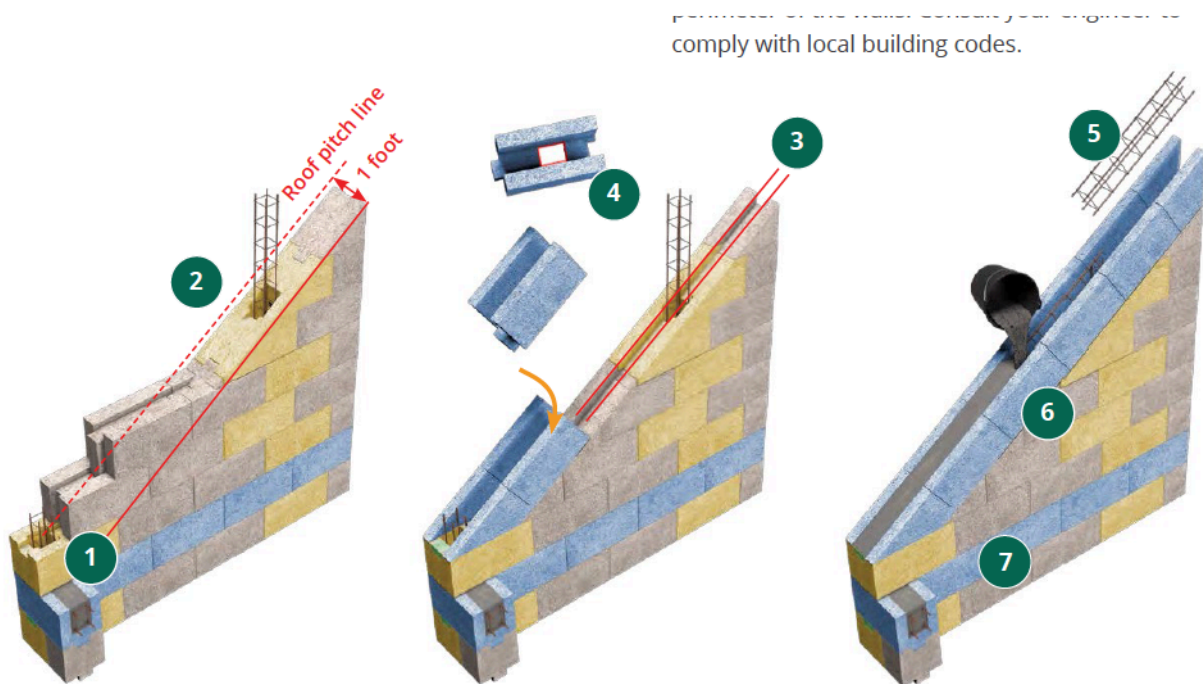

Method 1:

1. Build the wall with extended blocks one block short of the finished roofline
2. Mark the sloping roofline

3. Cut the wall on an angle but nice and level – as in hold the chainsaw level, perpendicular to the wall
4. Cut a groove to nestle the U Blocks in
5. Place the U blocks in the groove
6. continue as per **STEP 20**

#### Method 2:

1. Build the wall with extended blocks one block short of the finished roofline
2. Mark the sloping roofline
3. Cut the wall on an angle but nice and level – as in hold the chainsaw level, perpendicular to the wall
4. Cut the tongue of U blocks
5. Glue the U blocks to the sloped surface
6. Continue as per **STEP 20**

#### Method 3:

1. Build the wall with extended blocks on the finished roofline
2. Mark the sloping roofline
3. Cut the wall on an angle but nice and level – as in hold the chainsaw level, perpendicular to the wall
4. Cut a U channel groove to place the ring beam steel / timber / FRP members
5. Continue as per **STEP 20**

## 7. 2 B Erecting walls with the Steel Post and Beam load bearing system

---

### STAGE 2 B

Now the start is made, all the load bearing brackets are attached and in the right place, waterproofing is done and termite barrier (if needed) is installed, we can commence laying blocks. Use the 3D model to assure you have the right positioning of the walls.

Refer to the chapter [safety](#) and [tools](#) where we run through block placing, [handling and cutting](#) before starting to lay the blocks.

### STEP 1

#### **When using a timber or other tongue on the floor surface and creating a groove in the first layer of HempBLOCKs;**

Cut the tongues of the first blocks and create a groove that accommodates the tongue size. Keep the width as accurate as possible, but allowing a bit more for the dept of the groove. You can use a wall chaser, angle grinder or chainsaw.

### STEP 2



#### Note:

Start laying blocks with two corners and its wall in between. The aim to work to the stage so you have completed one wall and two corners. This way you can secure the load bearing system, and fill the void between the system and the block with the perlite / cement mix.

This will make this wall resistant to wind-loads that may occur during construction.

#### **When placing the first layer of blocks on concrete starter blocks;**

Clean the floor surface and bottom of the block with an air blower. Place the first layer of blocks in the right position with the tongue in the starter block groove.

#### **When placing the first layer of blocks on a tongue;**

Clean the floor surface and bottom of the block with an air blower. Place the first layer of blocks in the right position with the groove on top of the tongue so they interlock.

### STEP 3

Now you know where the wall should be situated, you could install what we call brickies' stays or a steel square attached to the inner corner of the wall.

### STEP 4

Lay the second layer in a staggered fashion at all times. This is called a *stretching bond* where the block

on top of the bottom one is centred over the end of the lower block.

What ever the configuration, the tongue of the top blocks will lock the blocks in through the connection with the groove of the lower blocks.

When two female blocks need to be connected, fill in the void with loose hempcrete rubble and / or a tongue that was cut off prior.

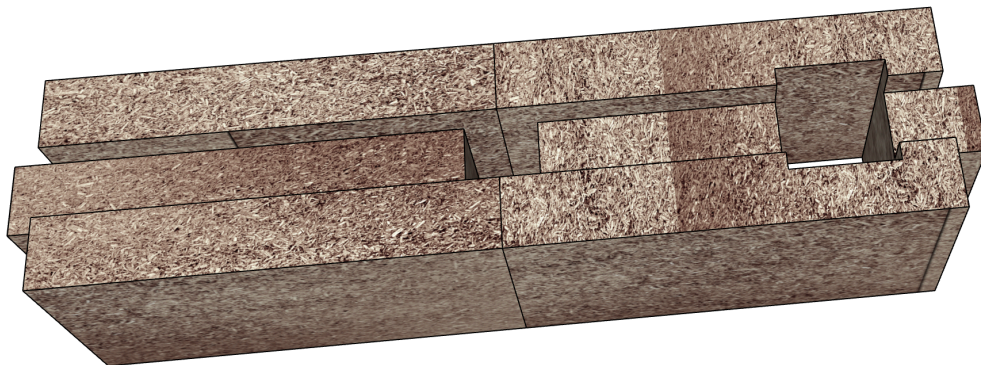

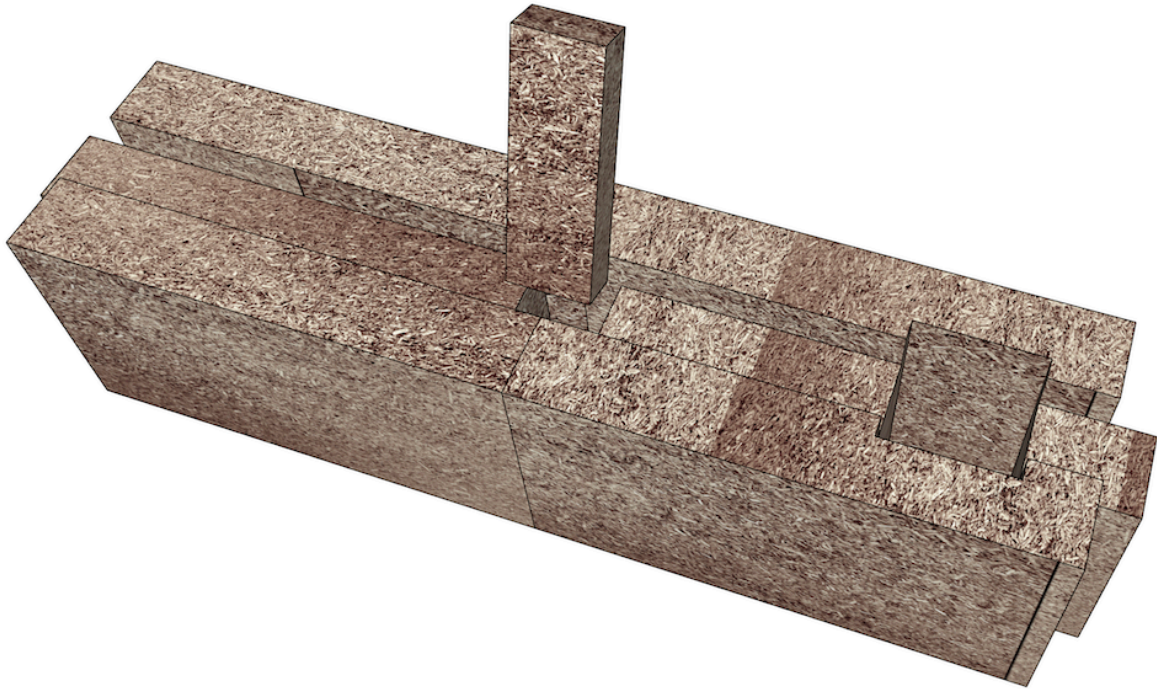

**The column blocks:**

The voids in the column blocks need to align as perfect as possible so the vertical void lines up and is plum and straight.

In general the blocks interlock at the top and bottom as much as possible blocks on each side.

Air blow the connecting surfaces (top and bottom of the next block) before interlocking them together.

It is handy to create these 'plates' so your hammer connects with the full surface of the block.

Use a 1.5 Kg ( 3 pound) dead blow over a rubber hammer. They bounce too much.

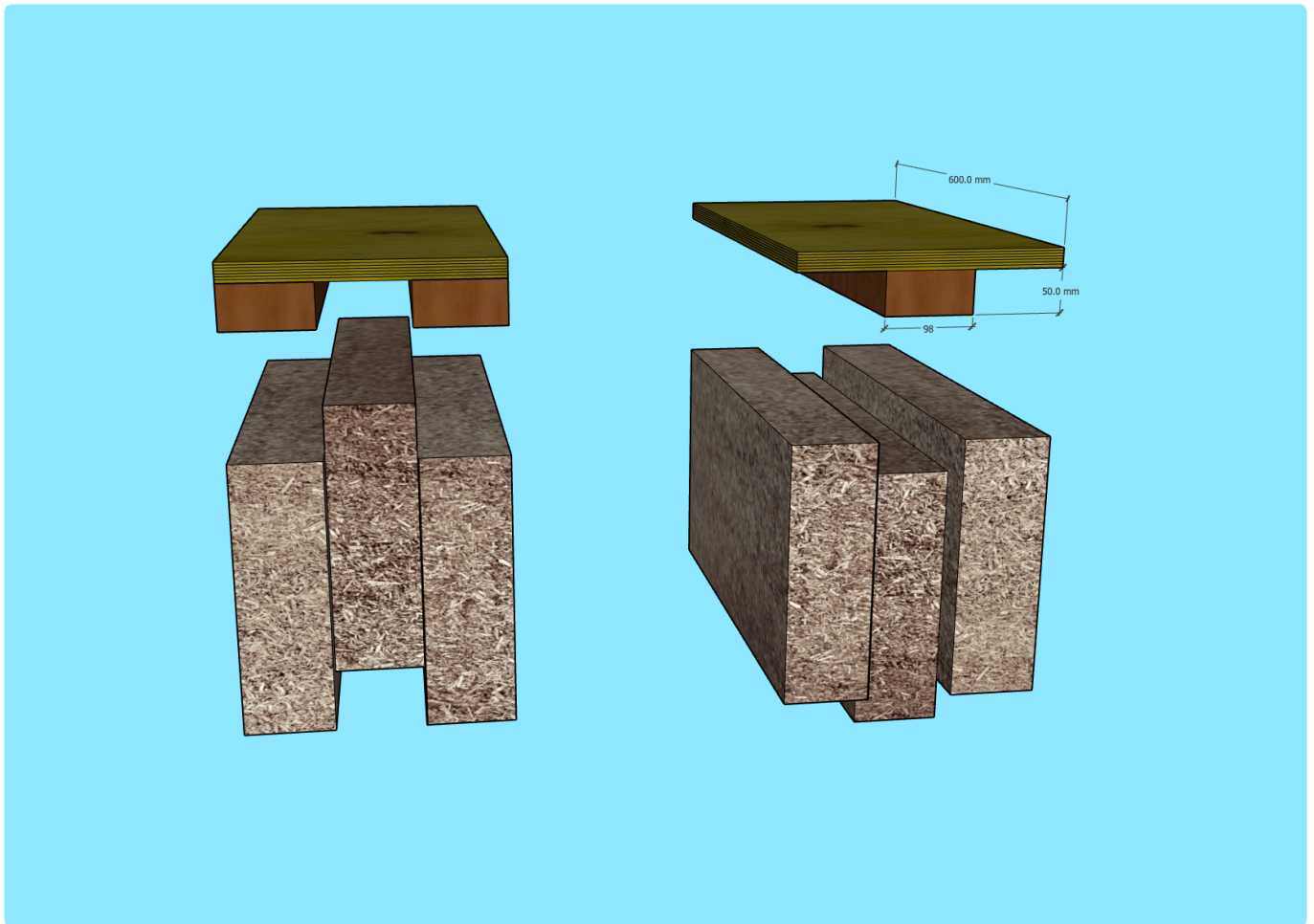

More info about the banger blocks [here](#).



<https://www.drop>

Go around the perimeter of the building. And continue with the corners of the wall you aim to finalise first.



<https://www.youtube.com/embed/MSr4WHBZMzs?rel=0>



<https://www.youtube.com/embed/3eYdvFFZ2NU?rel=0>

When a block is butted (not a tongue and groove connection) fill the vertical groove void between the blocks with the off-cut of the tongue.

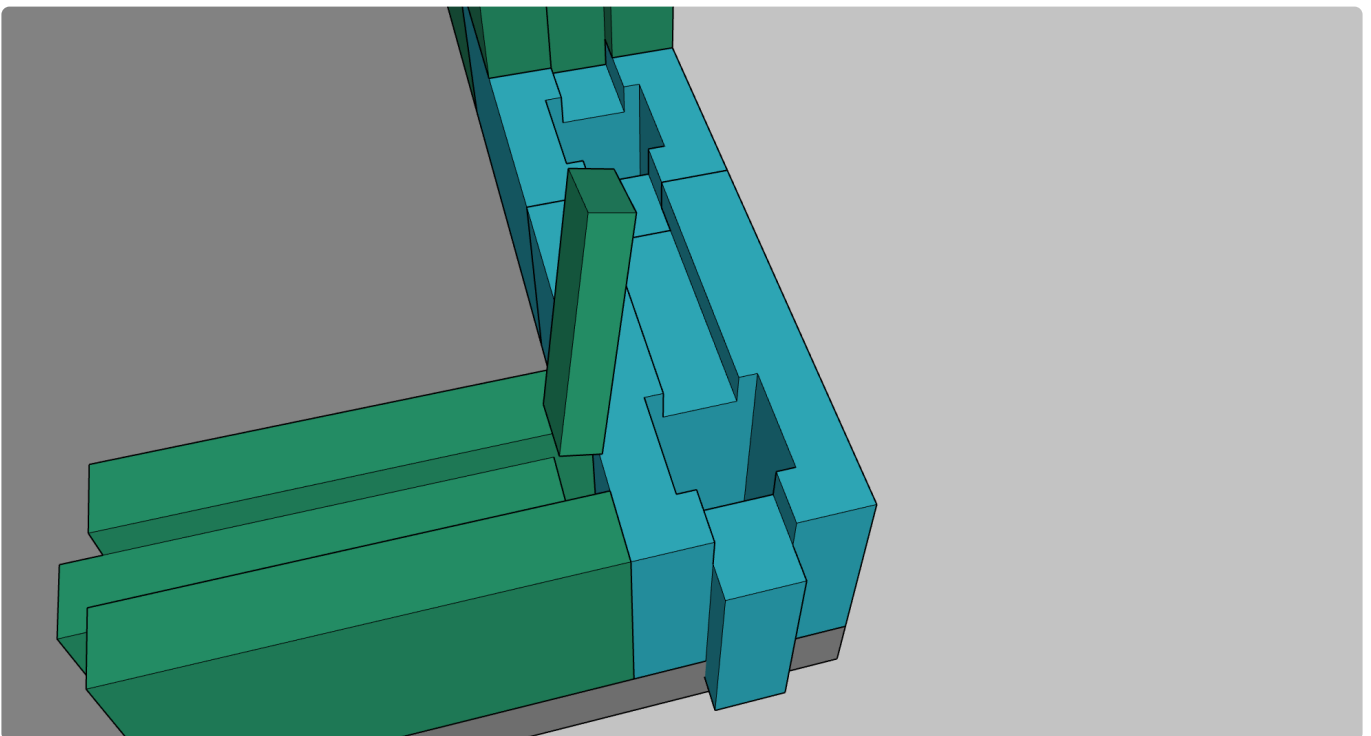

!!! On the corners, plumb is measured from the side of the blocks, past the heads of the underlaying

block. Never the male side! The male sides of the blocks are slightly irregular.  
Use of a plumb blob is recommended.

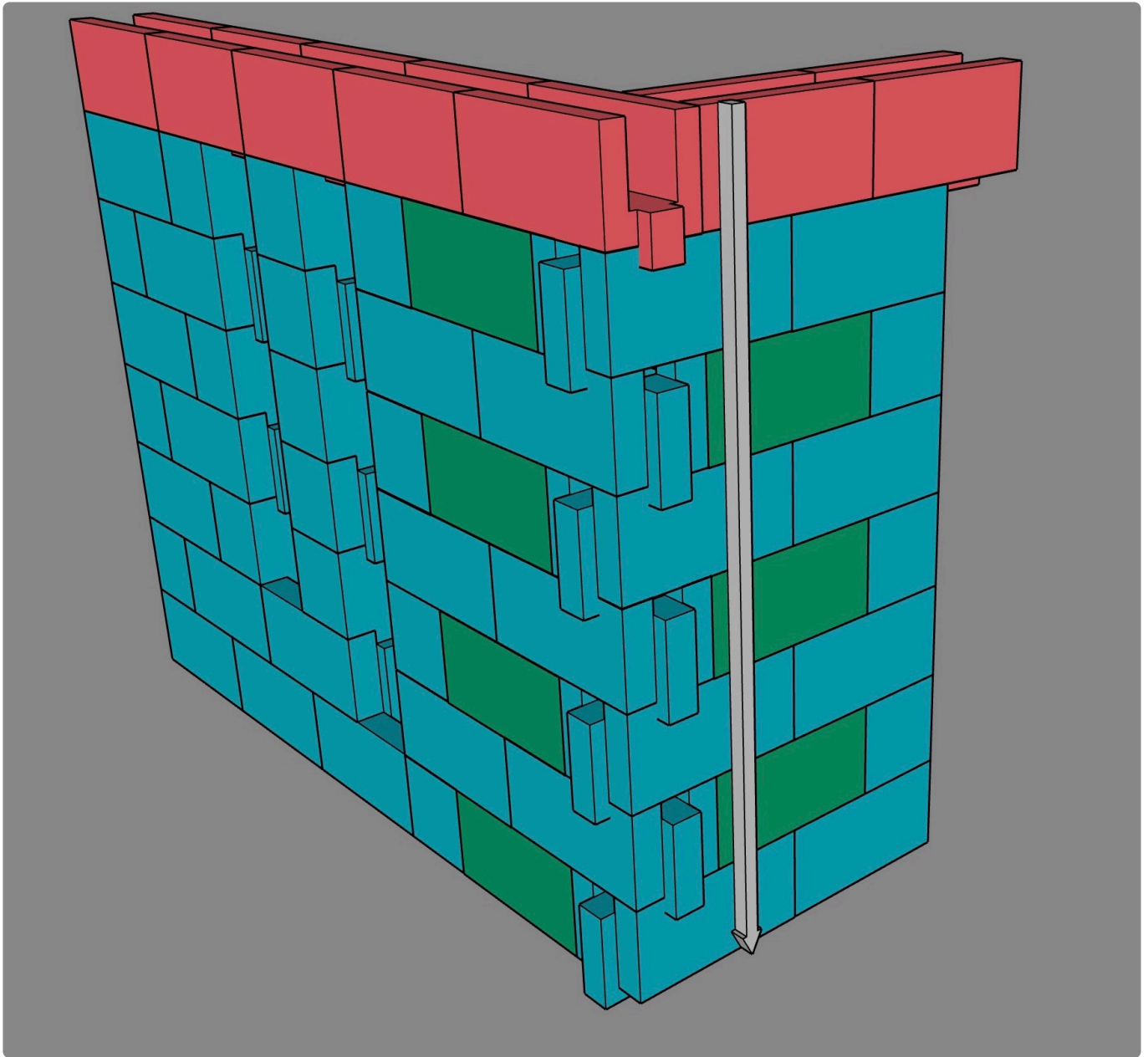

Use packers or shave high spots where needed.

#### **STEP 5**

Cut a groove in the part that connects with the next block to receive the tongue of the block placed on top.

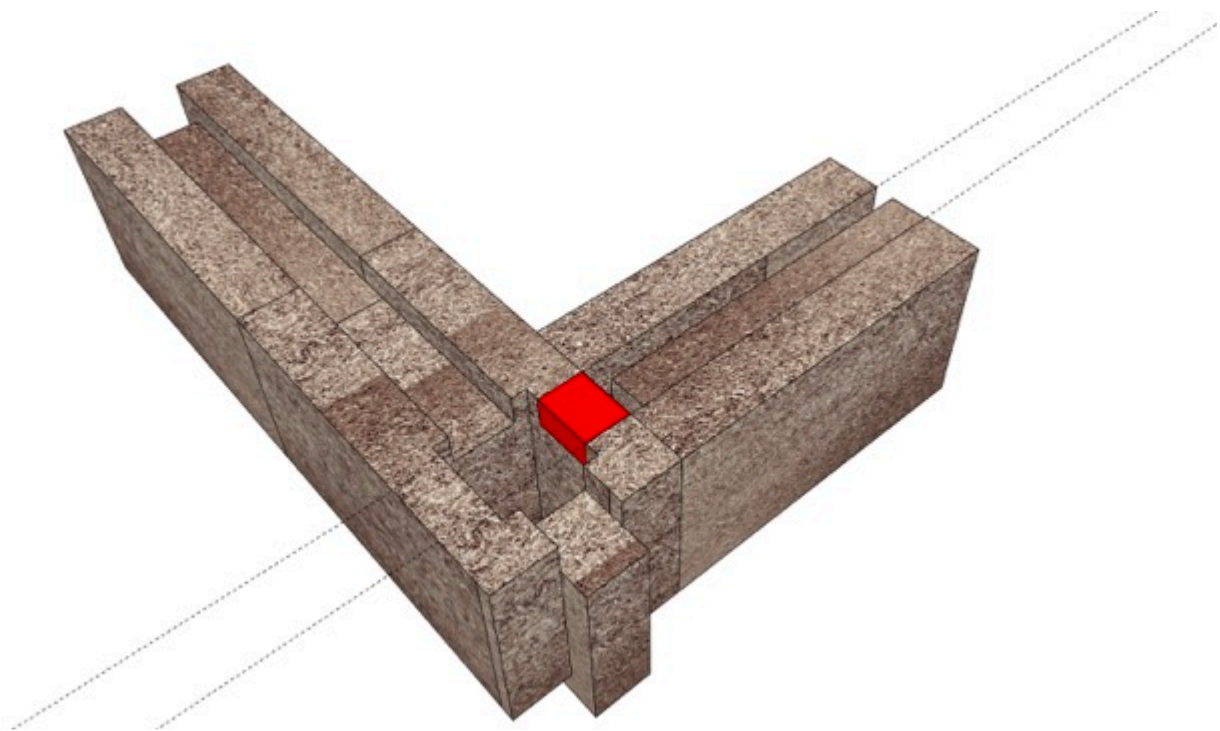
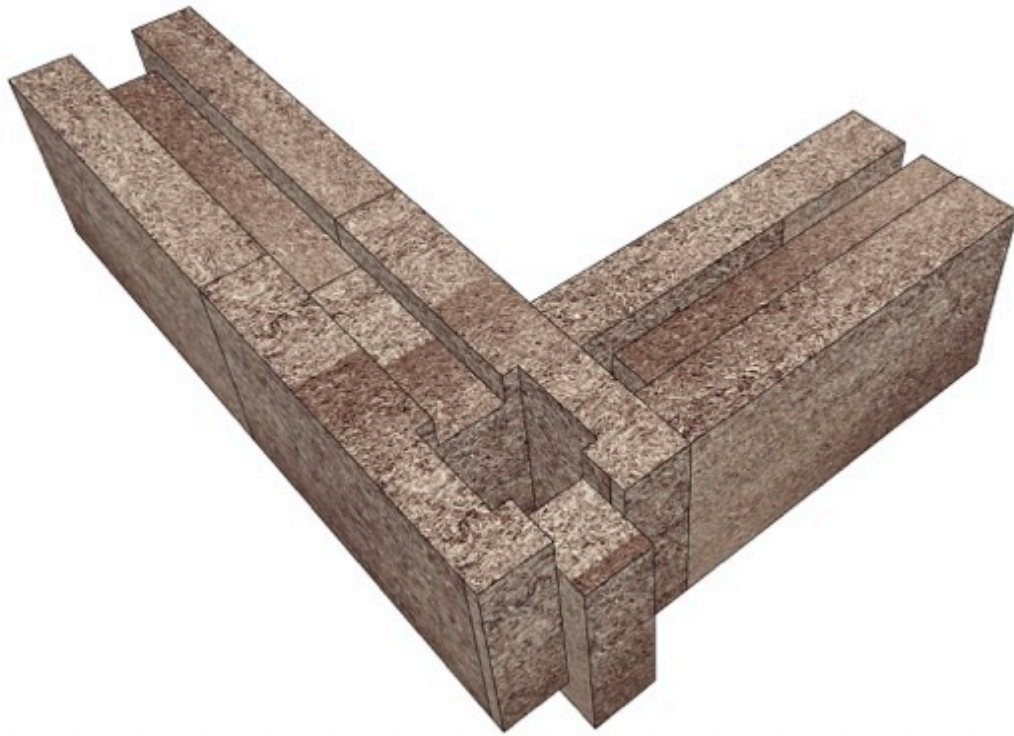

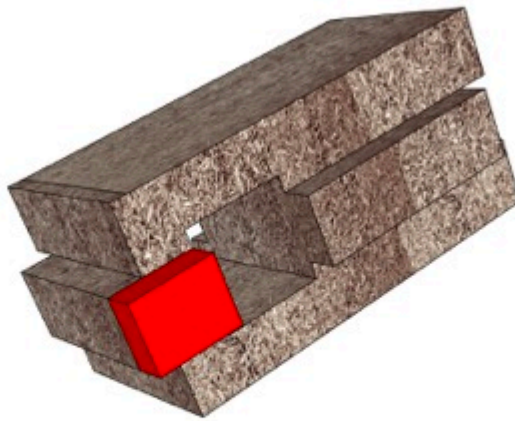
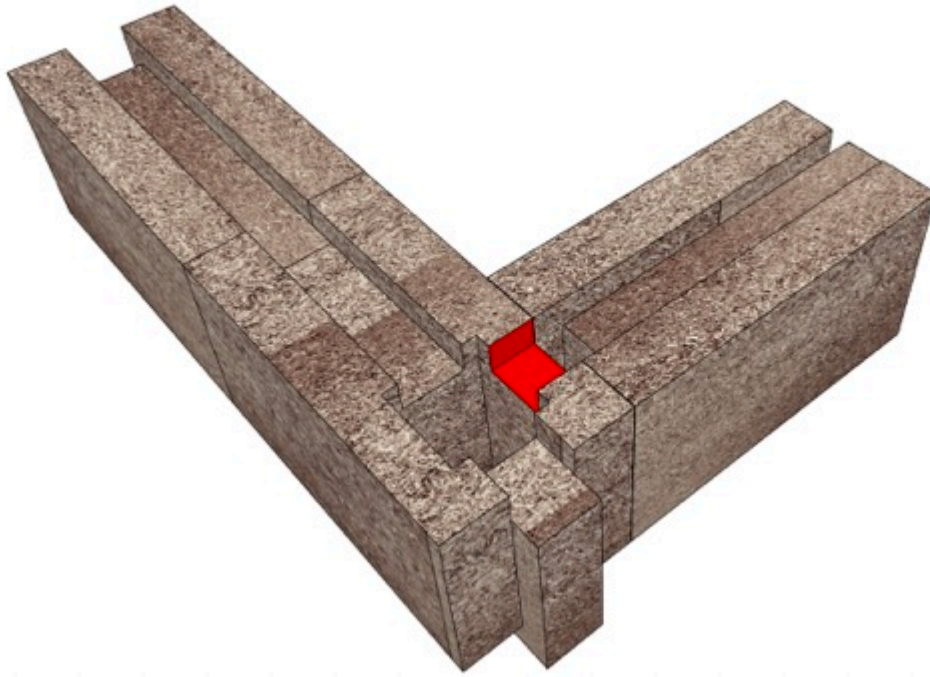



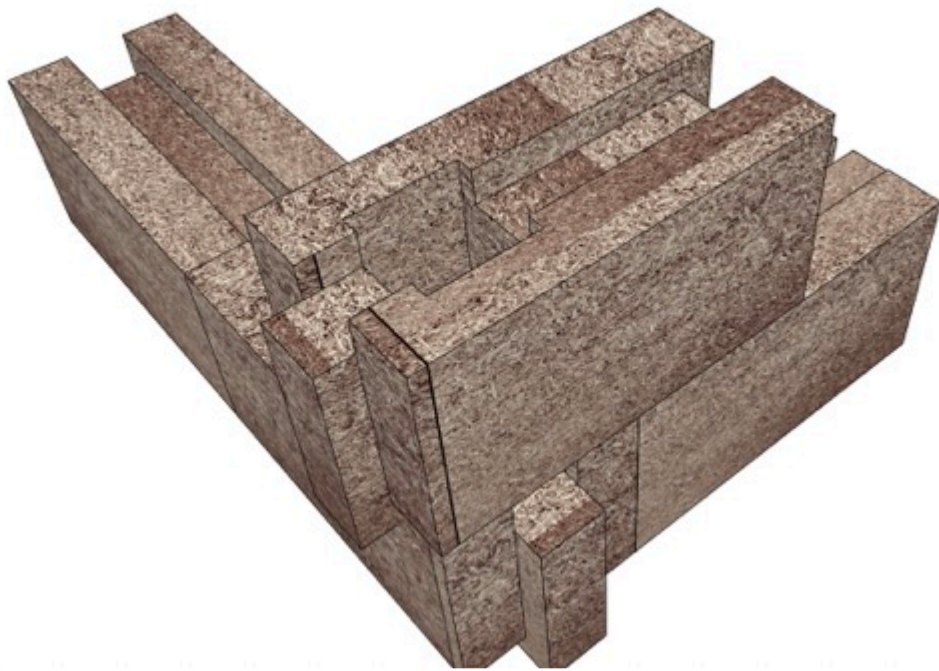

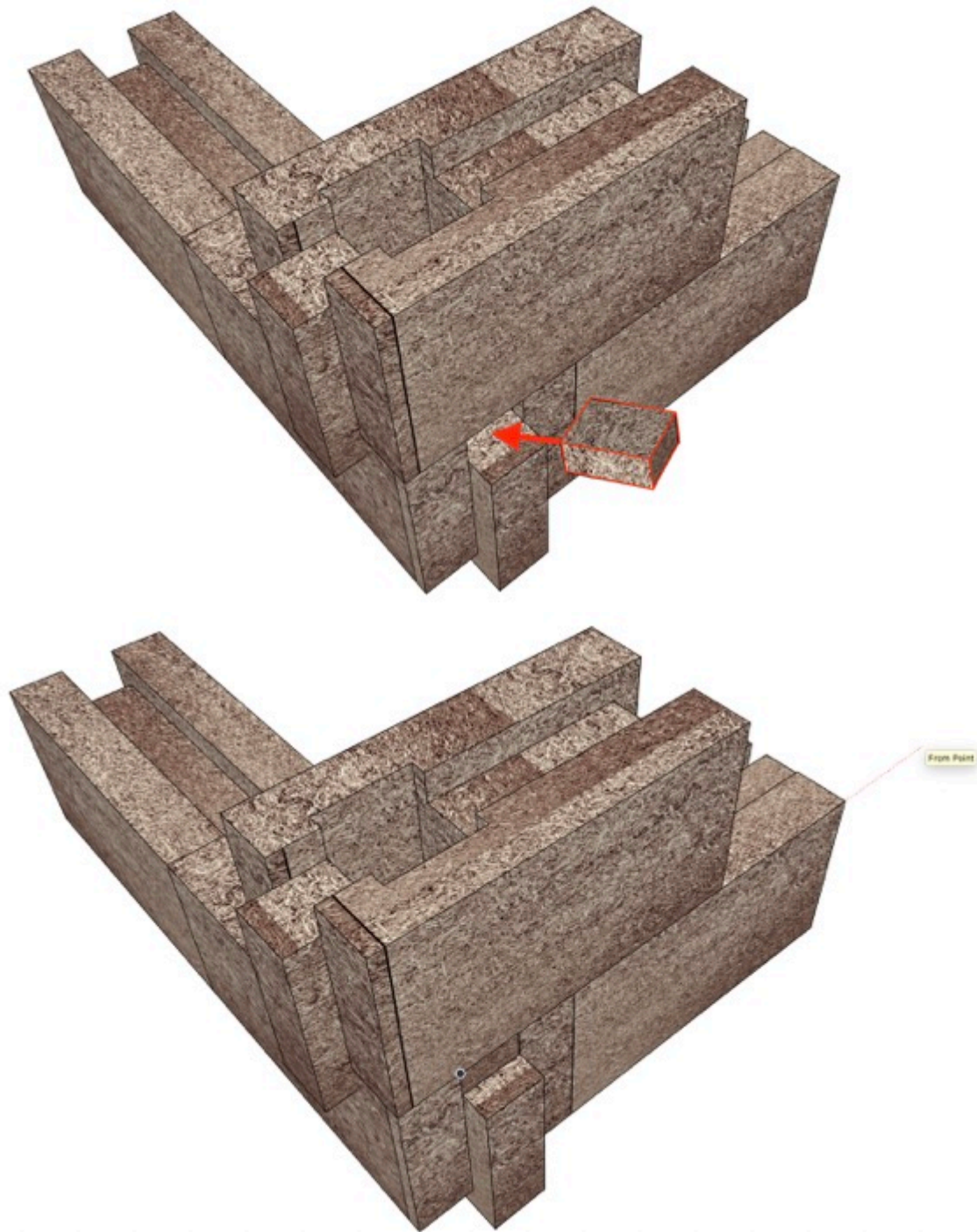

The general gist is to adapt the blocks so the interlocking system is used as much as possible.

Some buildings might have been engineered with a steel bracing element. It will be encased by the HempBLOCKs.

Placed and secure the bracing elements first.









- split the block over long
- mark and cut out the material so the block fits around the frame with some room
- place the halves around the frame element with a thick glue on the connecting parts
- secure the halves with long screws and some glue- the screws can be taken out at a later stage -
- the block on top will be held together by the groove of the bottom block.

**Note:**

As the wall is build, the walls will slightly shift out of plumb because interlocking the blocks moves them. Check the 3 axes of the walls regularly. **Level** line, **plumb** and **vertical** so your blocks don't tilt in our out. Use packers where needed.

**Note:**

Best to have some struts in place on long walls and lintels to ensure blast winds dont push them over before they are reinforced.



[Building HempBLOCK walls 1](#)

[Building HempBLOCK walls 2](#)



Note:

Here a demonstration how to handle your block-layer the next block;



<https://www.youtube.com/embed/QaVVpy5Lb6k?rel=0>

<https://www.youtube.com/embed/QaVVpy5Lb6k?rel=0>

### STEP 6

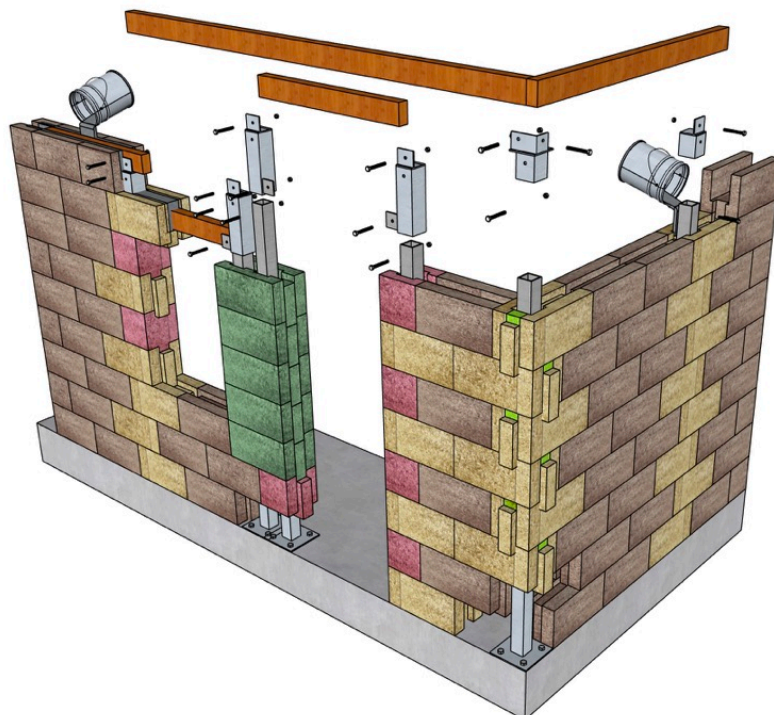



When you reach lintel or header height, you can get the infrastructure for the load bearing system ready before continuing with laying blocks.



## STEP 7

The lintel supports are put in place and held while the lintel blocks are positioned on it. Aluminium, or steel brackets, timber or steel supports can be used in combination with props that are properly secured to the brackets or supports.

Wax or oil the steel supports so the infill material does not bond to the steel surfaces. You can also use packing tape and wax or oil it as it does not bind to the perlite or concrete infill.





Timber lintel block supports.



Aluminium lintel block supports.

Secure the stays so they are solid and can not fall to avoid injury and damage.

### **STEP 8**

Position the U blocks preferable with at least 70mm support onto the corner column block.

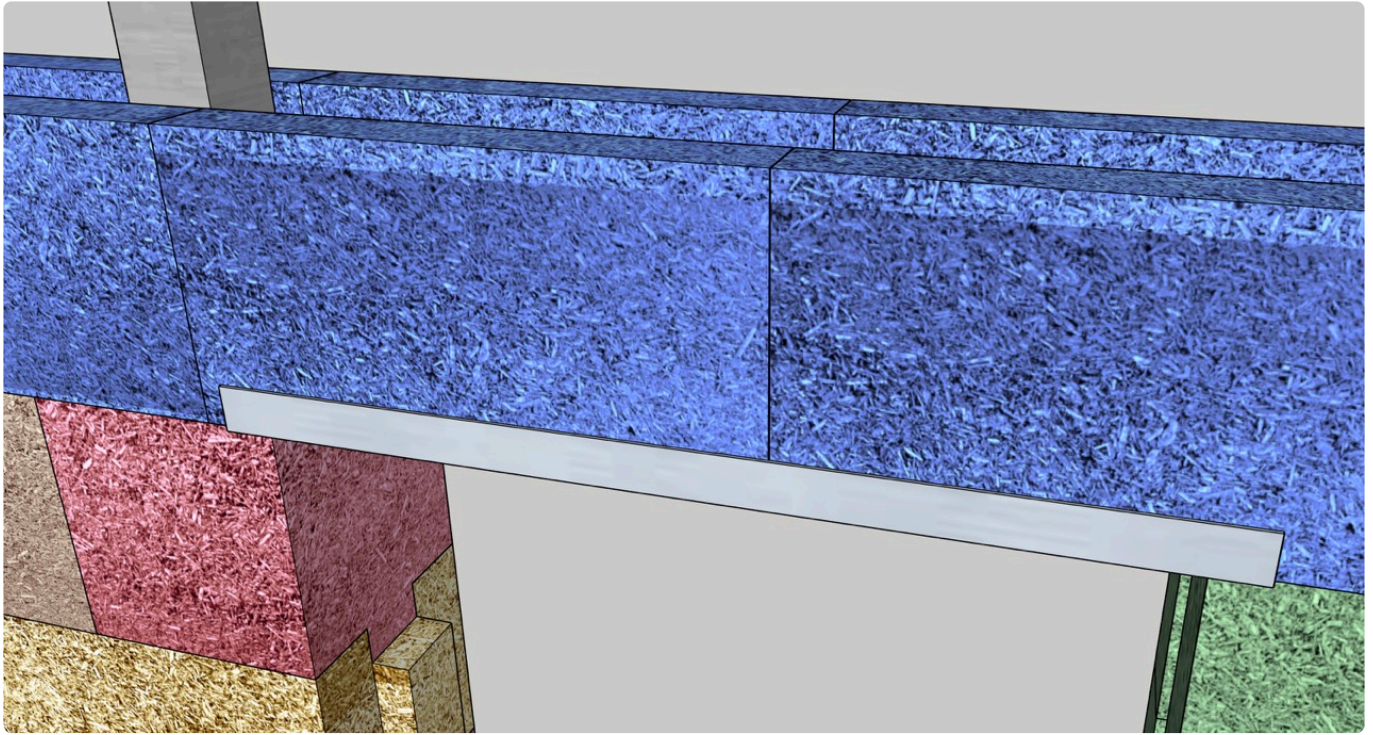

The first and last U block might need to [cut a 150 × 150 mm hole](#) if they overlap the column hole.

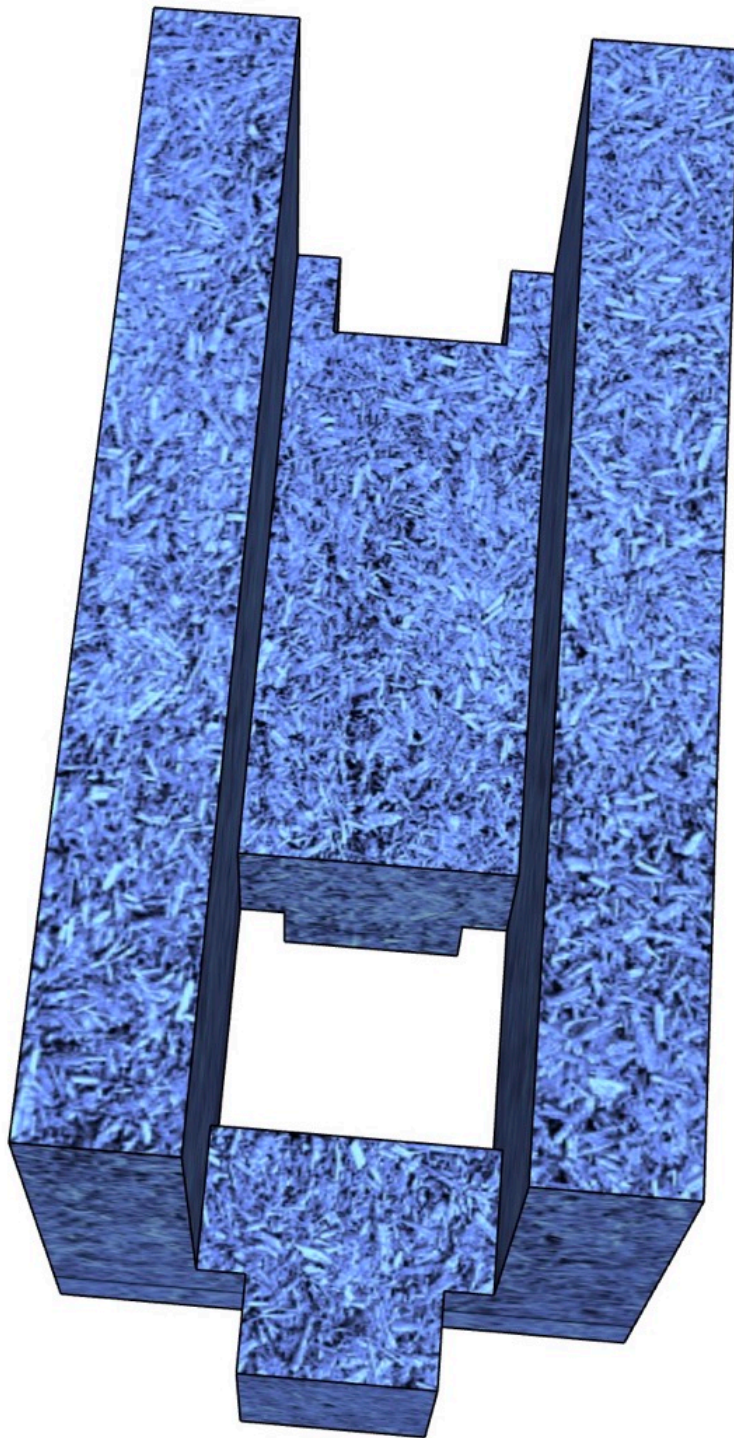
**STEP 9**

With the lintel blocks in place, connect the posts to the lintels/ headers as per engineers specifications.



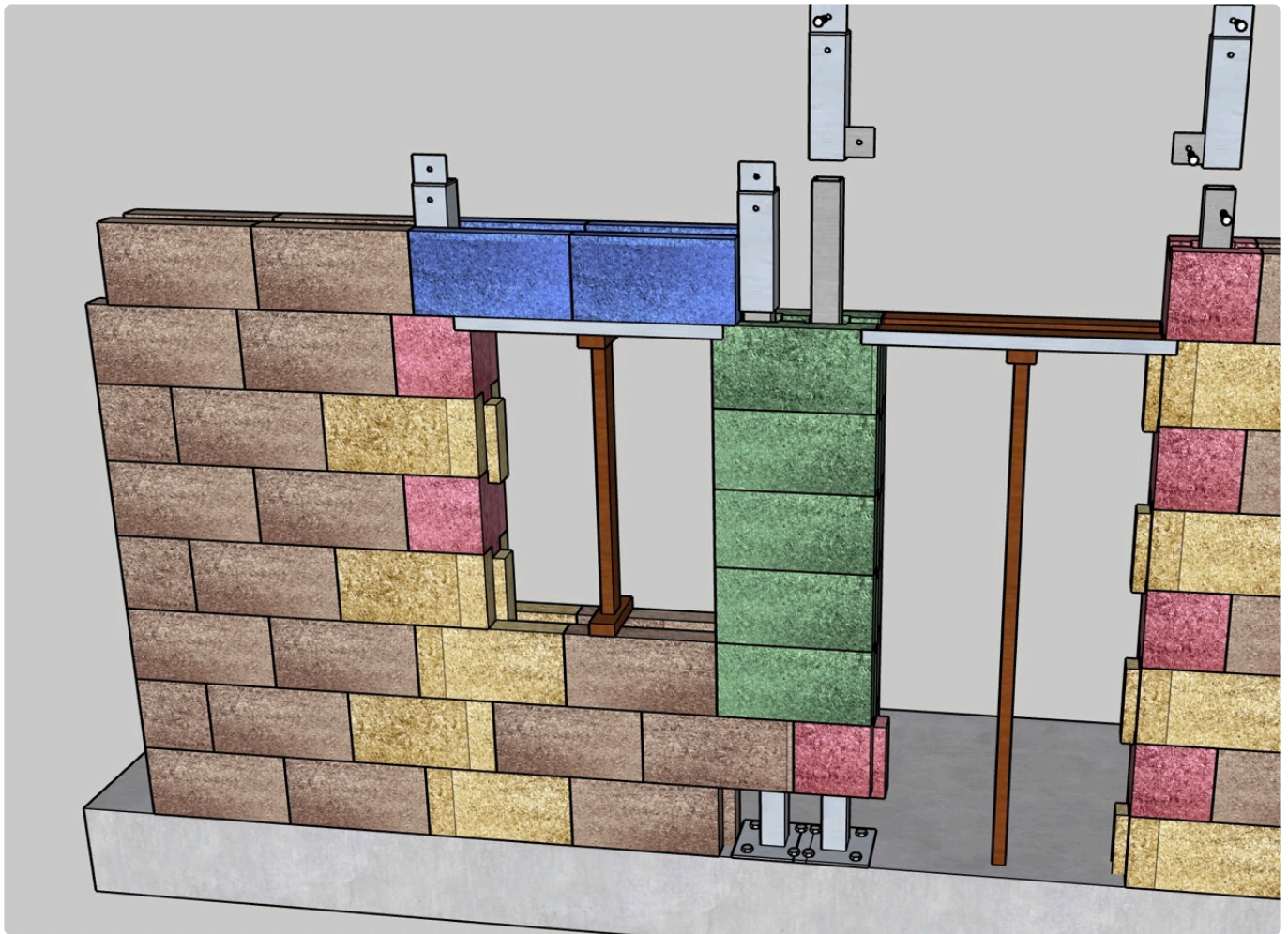

## STEP 10

The space between the posts and U or lintel blocks will be filled with a perlite / cement mix. For the infill to adhere to the timber or FRP lintels / headers, we need to create a 'key'. We do this with screws or dove tale timbers.

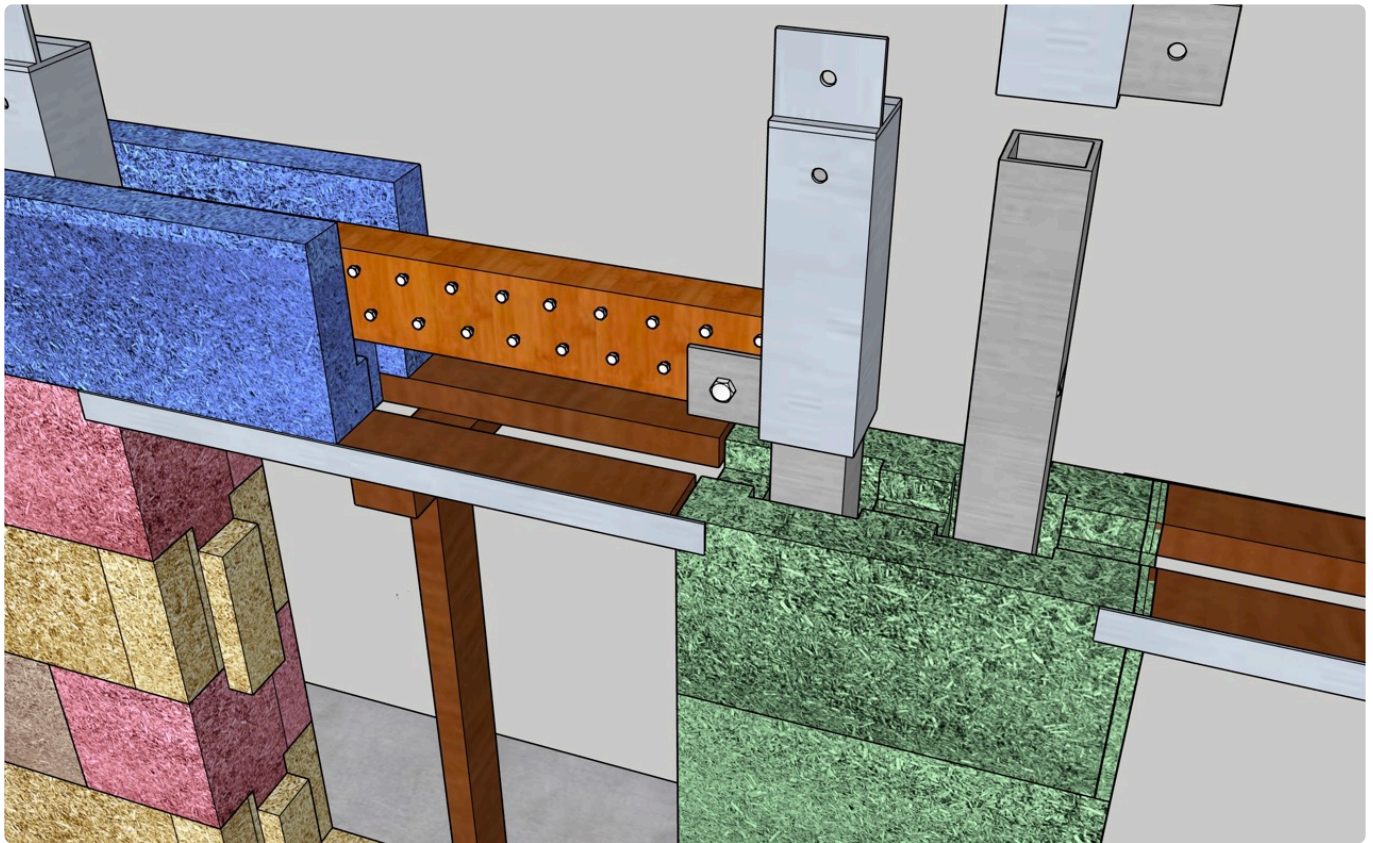

**STEP 11**

Connect the posts to the steel brackets or feet with steel screws or bolts and nuts as per engineering specifications.

**STEP 12**

The load bearing posts are now connected to the floor brackets or steel sleeves.  
Take pictures or have your engineer check the connections.

**STEP 13**

Install the sills to engineer specifications.  
Here an example:



**STEP 14**

Remove all rubble and debris with an air blower.

**STEP 15**

Block the holes in the bottom column blocks and where holes have been made to connect the lintels / headers with the columns on both sides so the perlite mix does not flow out.

We use timber planks or ply and roofing screws to keep them temporarily in place.

**STEP 16**

Go around the walls and fill in other voids with either;

- hempcrete or a
- hempcrete/perlite mix
- lime mortar
- expandable foam

Pay attention to the gaps between the U blocks used to create the lintel / header. Concrete or the perlite mix will pour through it if not blocked off.







**STEP 17**

Brace and plumb the walls.



<https://www.youtube.com/embed/EZWAbn6phSs?rel=0>

<https://www.youtube.com/embed/EZWAbn6phSs?rel=0>

You can fix and fill the space around the posts and lintels in stages or preferably all the way.

## STEP 18

Before casting the perlite infill around columns, lintels / headers and bond beams go through this check list;

1. check if all reinforcing is correctly attached. Make pictures for your engineer if needed.
2. have the engineer or certifier check your work if required
3. check if your walls are straight
4. check all walls are plumb
5. check if all columns and lintel blocks / headers are reinforced are connected properly aligned and centre to the blocks
6. check if all holes in the blocks are filled or blocked up. Boxing of the lower end of the walls needs to be strongest as the perlite mix will create some pressure on these parts
7. assure you can go around the walls to be filled with planks and safe platforms

✿ NOTE:  
Perlite mix:

## STEP 19

Mix up the perlite or vermiculite mix.

Don't fill the voids when the blocks are still wet from excessive rain.

Check for cracks in the blocks to avoid blow outs.

If needed pour the sills or remaining space around the sill member.

You can poke gently with a rod for the concrete to flow down past the cages.

Check for blow outs.

When reaching the bond beam and lintel / header, fill it and screed the top off.

## STEP 20

After the perlite has set and hardened over a day or so, continue with laying the wall and work up to the final stage.

Here we place the lintel blocks to finish the flat wall or create the gables. **See Step 26**

Over a lintel / header you have to cut the tongue of the next blocks. You can use a lime based mortar or thick glue like 'Liquid nails' to adhere the blocks to each other.

Standard there is non or only one more layer to go on top of the lintel / header.

This will then be your ring beam.

Cut the 150 × 150 mm hole or groove to lift the blocks over the post where needed.

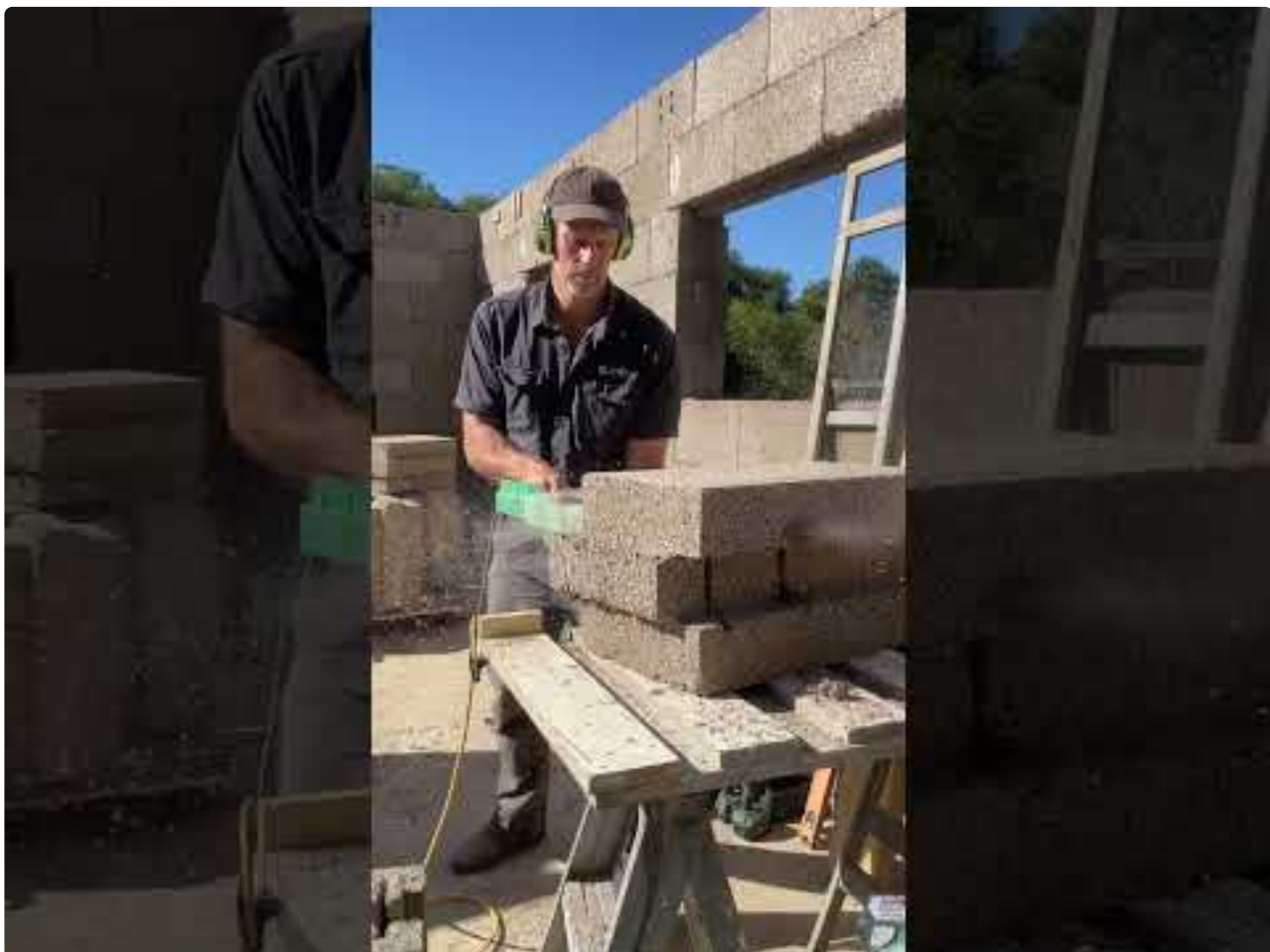

<https://www.youtube.com/embed/XLIDflqJlec?rel=0>



<https://www.youtube.com/embed/XLIDf1qJlec?rel=0>

## **STEP 21**

Prepare the ring beams / cages.

In some high wind regions you may need to attach the Burmon brackets that tie down your rafters or trusses in advance, and loop a steel strip around them to the beam. As per engineers specifications.





**STEP 22**

Place the U or lintel blocks.

In case of a sloping wall see **STEP 26**

### STEP 23

Connect the steel of the top plate to the column posts as per engineering specifications.

### STEP 24

Repeat from **STEP 14**

### STEP 25

Cast the perlite / vermiculite into the remaining column spaces and ring beam.

Screed the top of flat.

The wall is now ready for the roof!

### STEP 26

#### Method Sloping wall:

There are a few ways to create a sloping wall.

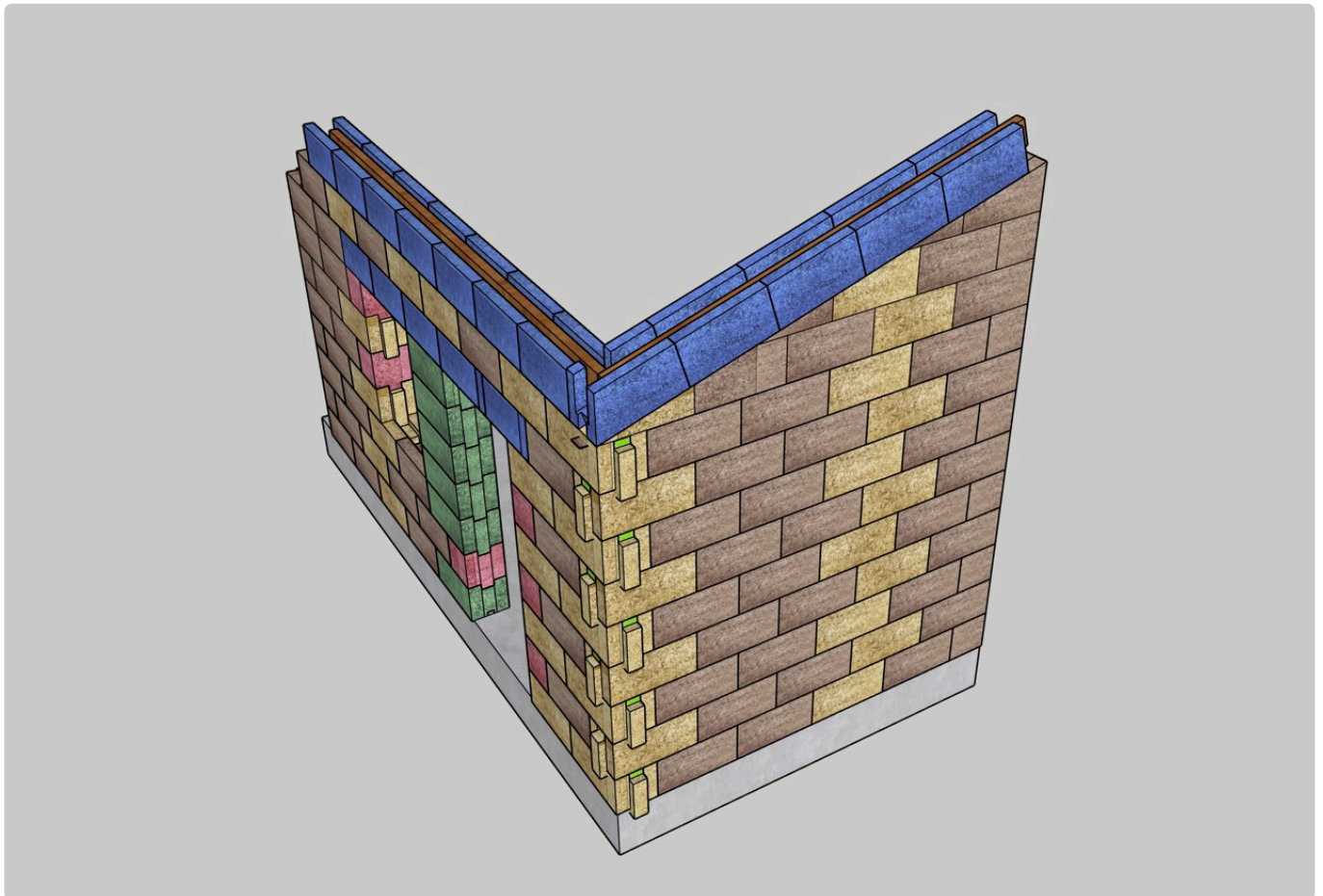

#### Method 1:

1. Build the wall with extended blocks one block short of the finished roofline

2. Mark the sloping roofline
3. Cut the wall on an angle but nice and level – as in hold the chainsaw level, perpendicular to the wall
4. Cut a groove to nestle the U Blocks in
5. Place the U blocks in the groove
6. continue as per **STEP 19**

#### Method 2:

1. Build the wall with extended blocks one block short of the finished roofline
2. Mark the sloping roofline
3. Cut the wall on an angle but nice and level – as in hold the chainsaw level, perpendicular to the wall
4. Cut the tongue of U blocks
5. Glue the U blocks to the sloped surface
6. Continue as per **STEP 19**

#### Method 3:

1. Build the wall with extended blocks on the finished roofline
2. Mark the sloping roofline
3. Cut the wall on an angle but nice and level – as in hold the chainsaw level, perpendicular to the wall
4. Cut a U channel groove to place the ring beam steel / timber / FRP members
5. Continue as per **STEP 19**

## 8. 2 C Erecting walls with the Fibre Reinforced Polymer load bearing system

### STAGE 2 C

Now the start is made, all the load bearing brackets are attached and in the right place, waterproofing is done and termite barrier (if needed) is installed, we can commence laying blocks. Use the 3D model to assure you have the right positioning of the walls.

Refer to the chapter [safety](#) and [tools](#) where we run through block placing, [handling and cutting](#) before starting to lay the blocks.

### STEP 1

When using a timber or other tongue on the floor surface and creating a groove in the first layer of HempBLOCKs;

Cut the tongues of the first blocks and create a groove that accommodates the tongue size. Keep the width as accurate as possible, but allowing a bit more for the dept of the groove. You can use a wall chaser, angle grinder or chain saw.

### STEP 2



#### Note:

Start laying blocks with two corners and its wall in between. The aim to work to the stage so you have completed one wall and two corners. This way you can secure the load bearing system, and fill the void between the system and the block with the perlite / cement mix.

This will make this wall resistant to wind-loads that may occur during construction.

When placing the first layer of blocks on concrete starter blocks;

Clean the floor surface and bottom of the block with an air blower. Place the first layer of blocks in the right position with the tongue in the starter block groove.

When placing the first layer of blocks on a tongue;

Clean the floor surface and bottom of the block with an air blower. Place the first layer of blocks in the right position with the groove on top of the tongue so they interlock.

### STEP 3

Now you know where the wall should be situated, you could install what we call brickies' stays or a steel square attached to the inner corner of the wall.

### STEP 4

Lay the second layer in a staggered fashion at all times. This is called a *stretching bond* where the block

on top of the bottom one is centred over the end of the lower block.

What ever the configuration, the tongue of the top blocks will lock the blocks in through the connection with the groove of the lower blocks.

When two female blocks need to be connected, fill in the void with loose hempcrete rubble and / or a tongue that was cut off prior.

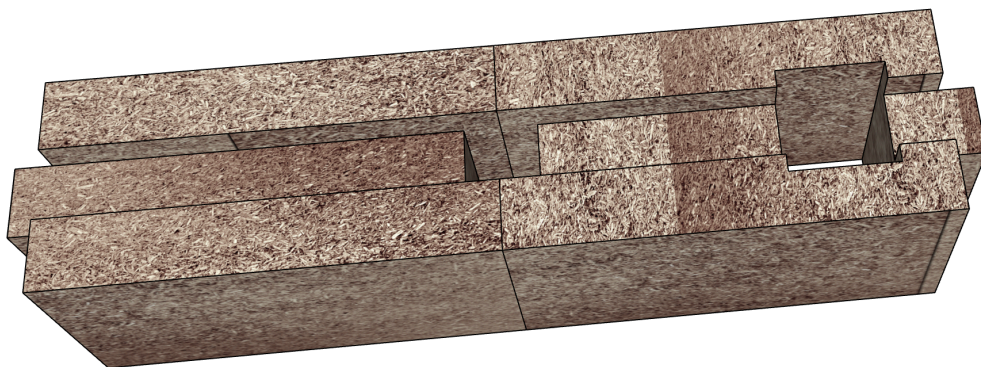
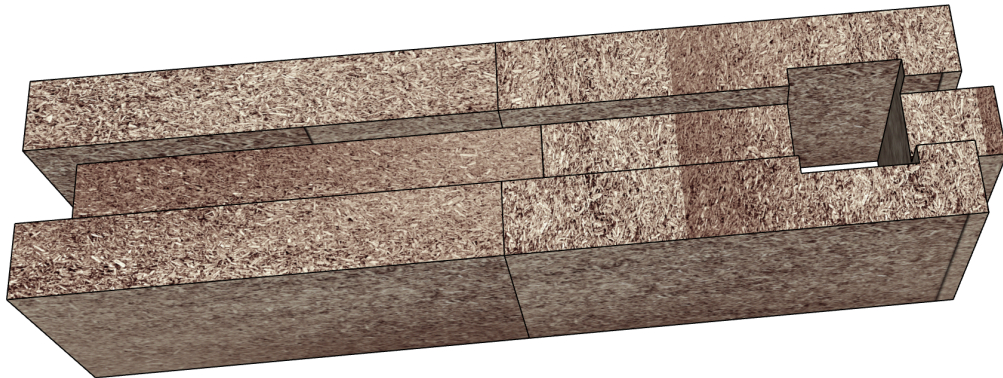

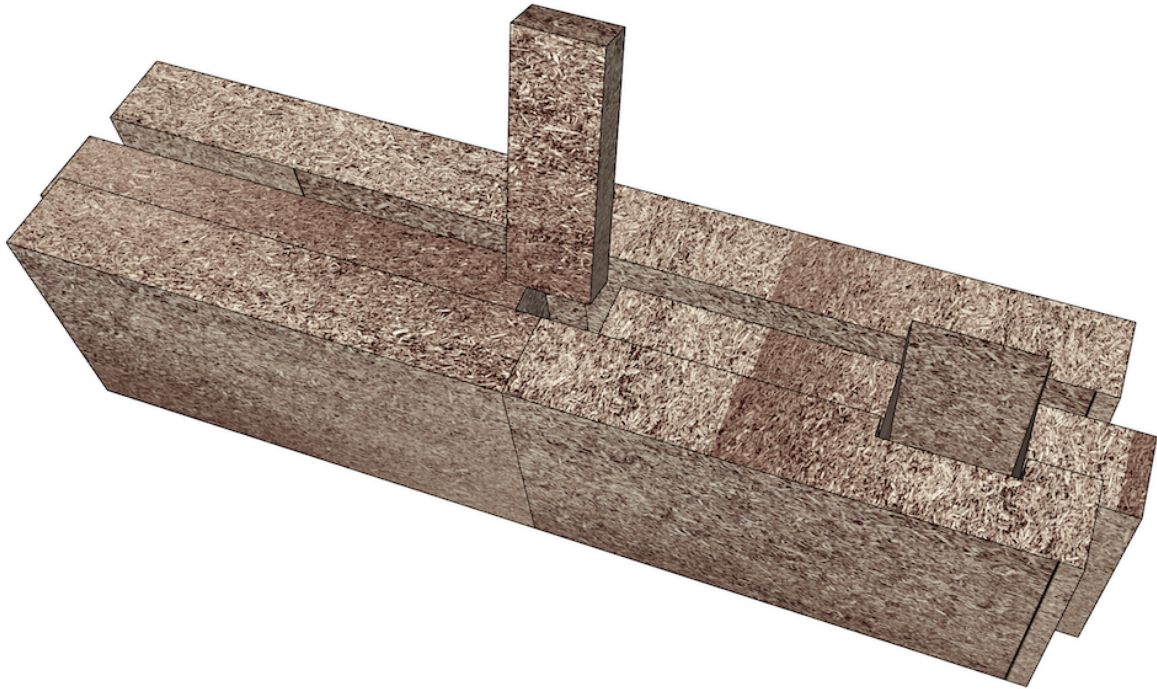

For the column blocks:

The voids in the column blocks need to align as perfect as possible so the vertical void lines up and is plum and straight.

In general the blocks interlock at the top and bottom as much as possible blocks on each side.

Air blow the connecting surfaces (top and bottom of the next block) before interlocking them together.

It is handy to create these 'plates' so your hammer connects with the full surface of the block.

Use a 1.5 Kg ( 3 pound) dead blow over a rubber hammer. They bounce too much.



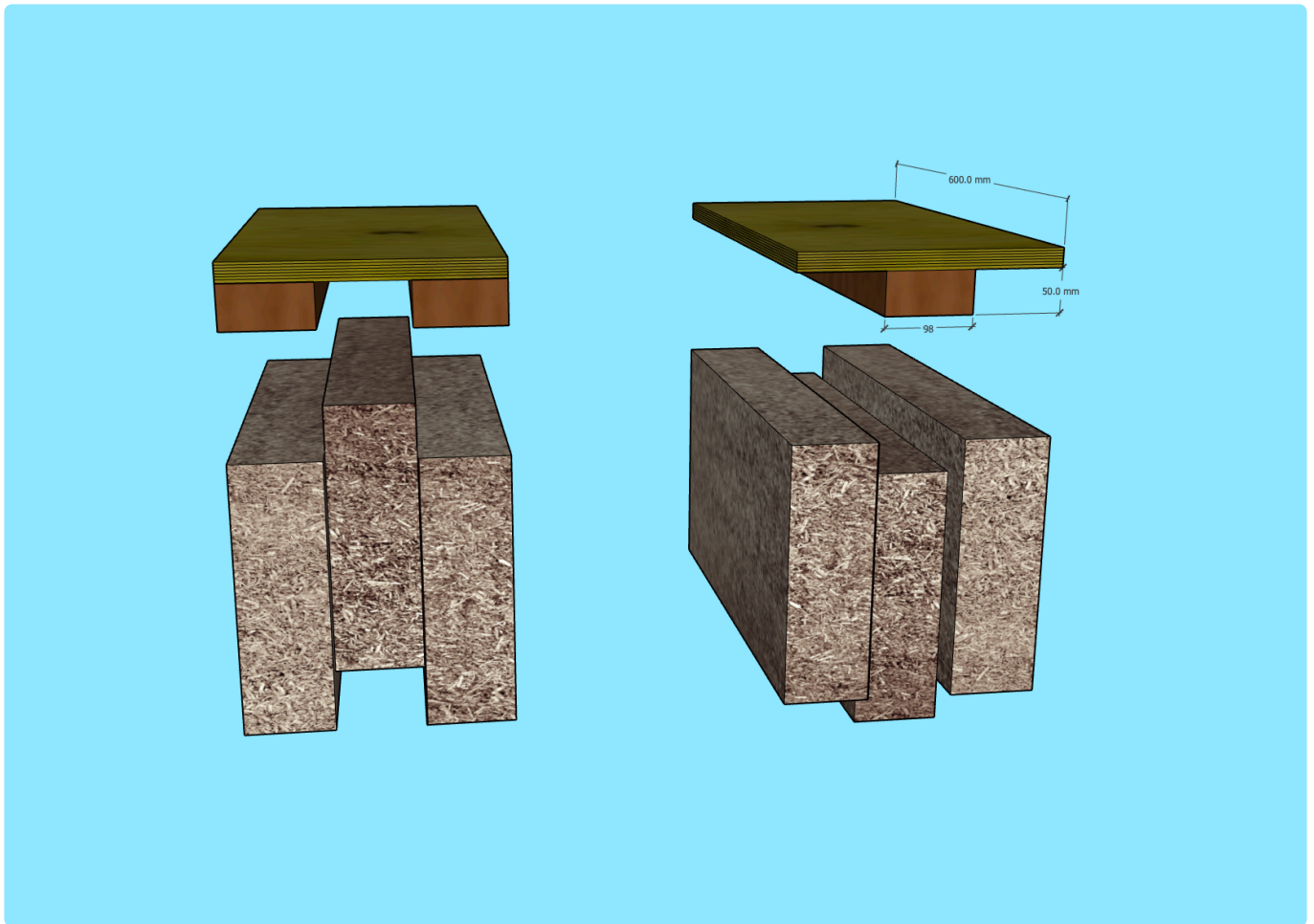

More info about the banger pads [here](#).



<https://www.drop>

Go around the perimeter of the building. And continue with the corners of the wall you aim to finalise first.



<https://www.youtube.com/embed/MSr4WHBZMzs?rel=0>

<https://www.youtube.com/embed/MSr4WHBZMzs?rel=0>



<https://www.youtube.com/embed/3eYdvFFZ2NU?rel=0>

<https://www.youtube.com/embed/3eYdvFFZ2NU?rel=0>

When a block is butted (not a tongue and groove connection) fill the vertical groove void between the blocks with the off-cut of the tongue.

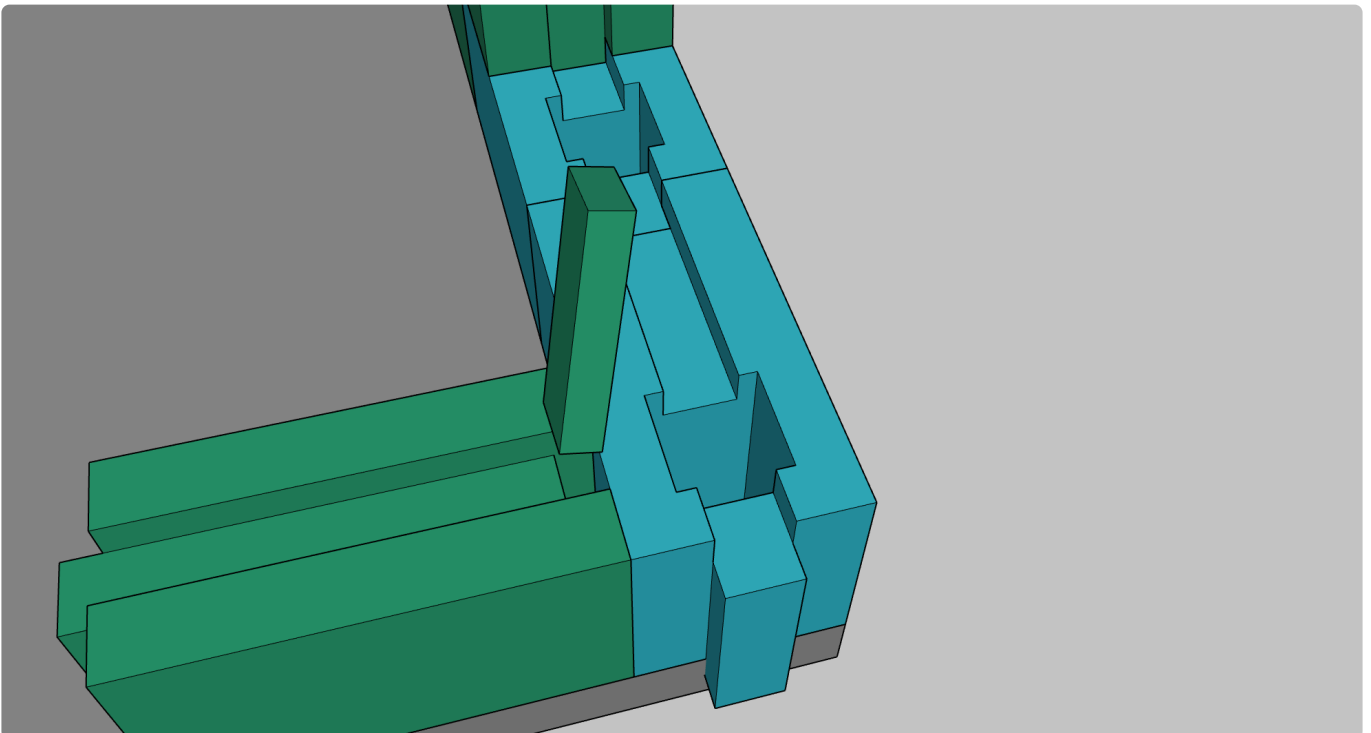

Use packers or shave high spots where needed.

### STEP 5

Cut a groove in the part that connects with the next block to receive the tongue of the block placed on top.

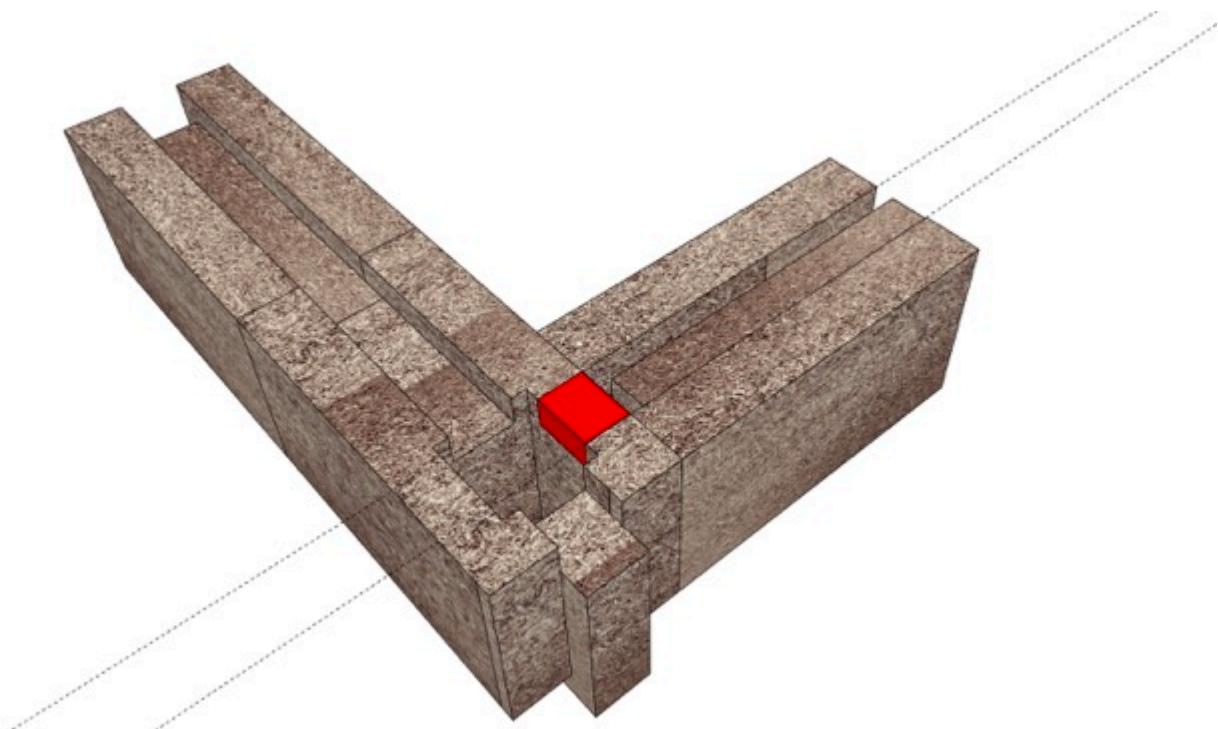
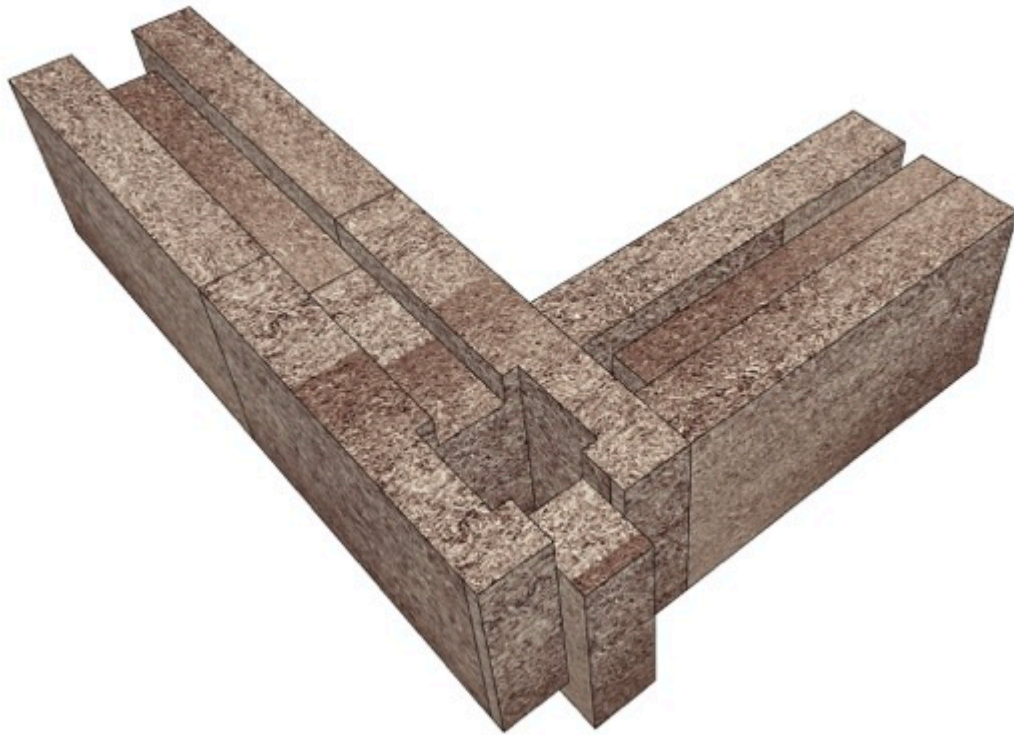

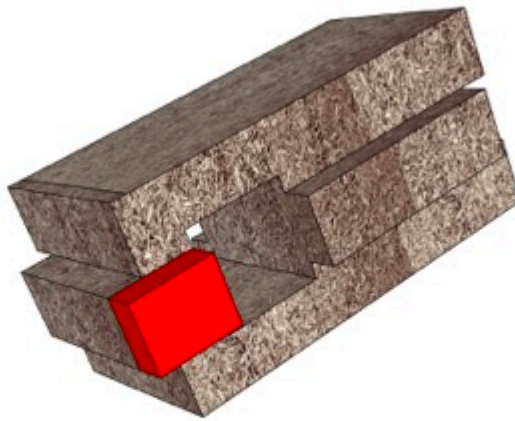
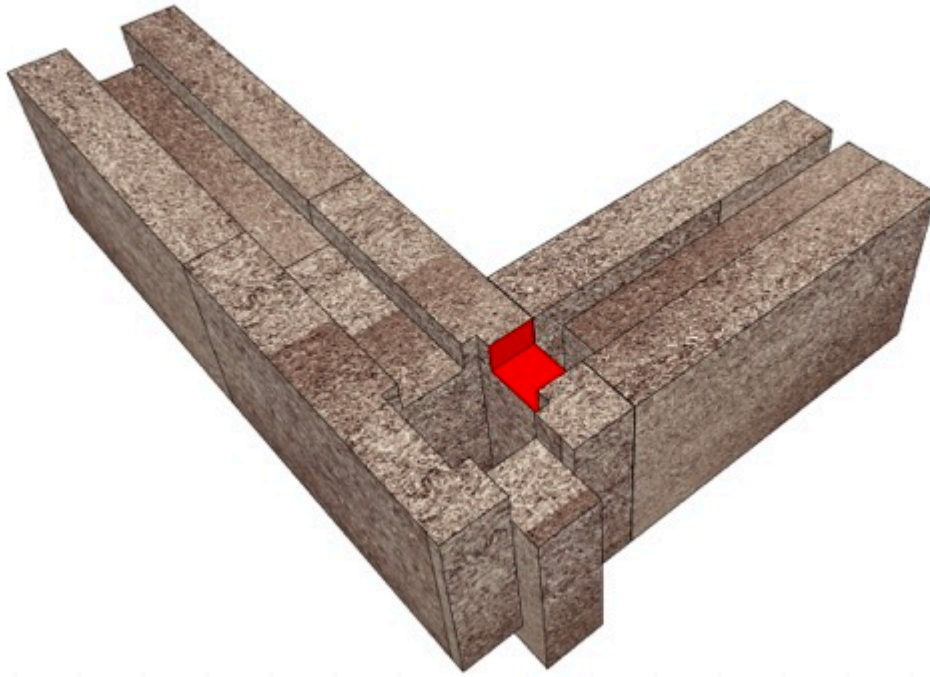

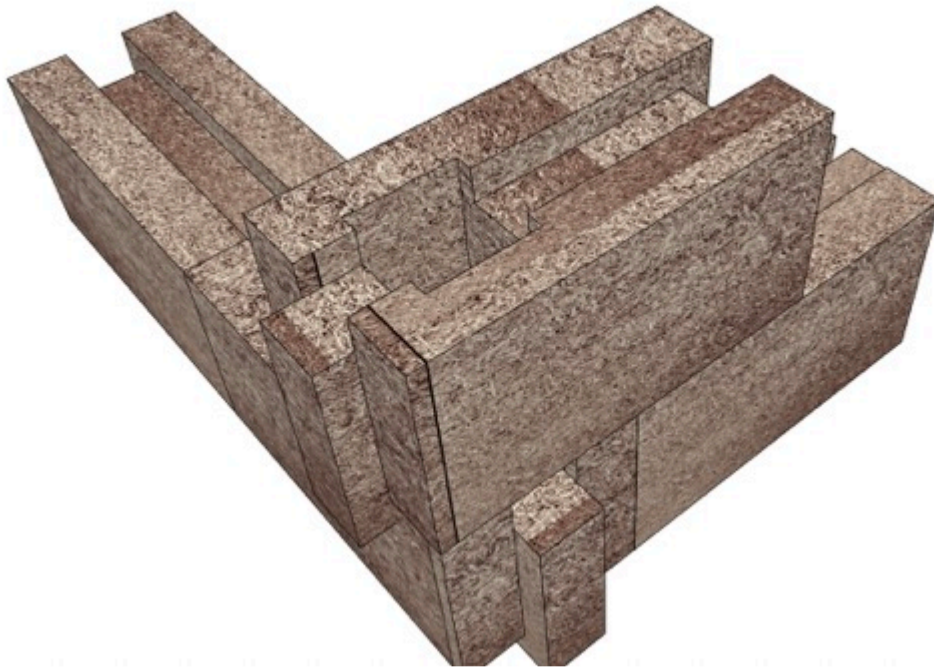

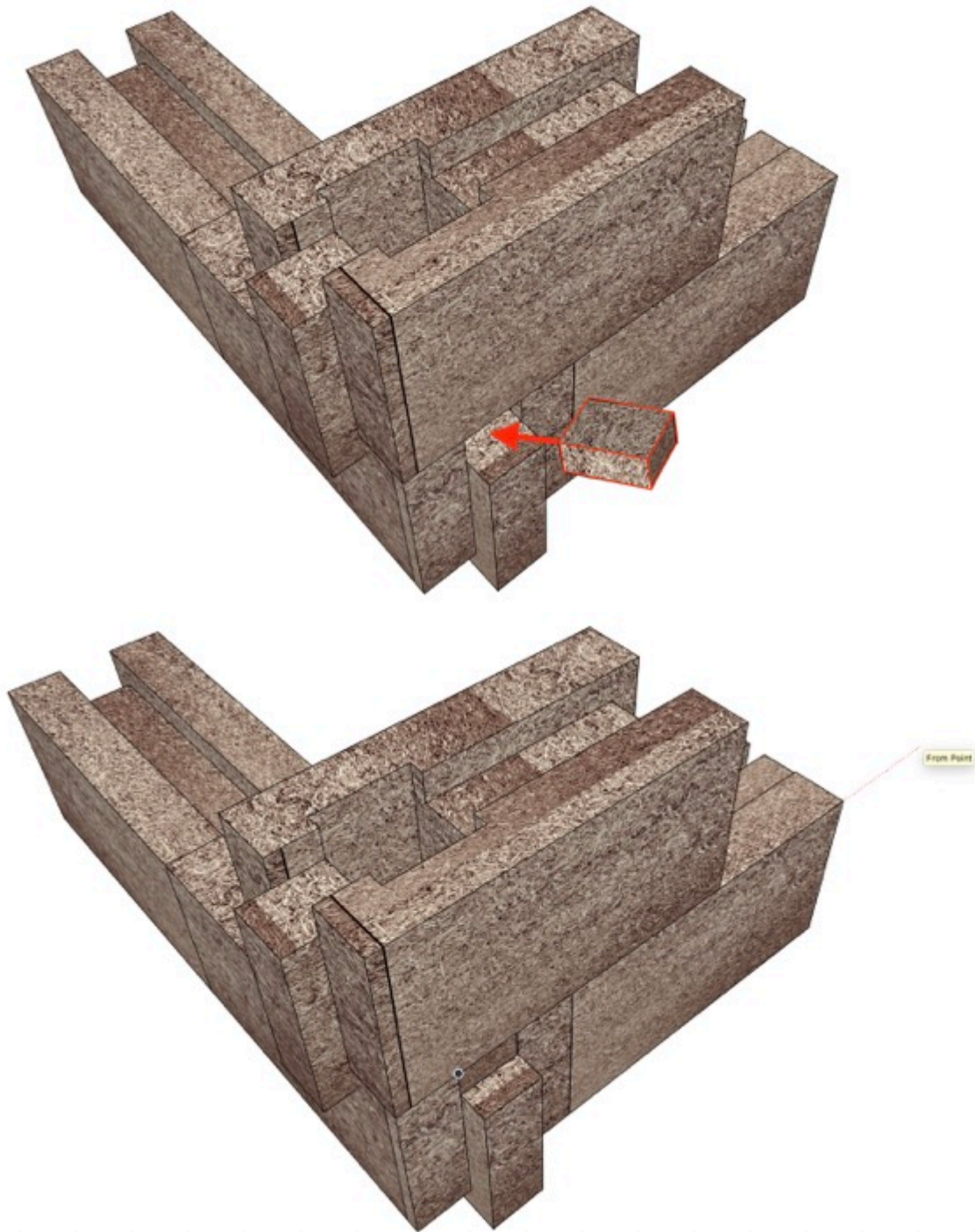

The general gist is to adapt the blocks so the interlocking system is used as much as possible.

!!! On the corners, plumb is measured from the side of the blocks, past the heads of the underlaying block. Never the male side! The male sides of the blocks are slightly irregular.  
Use of a plumb blob is recommended.!!!



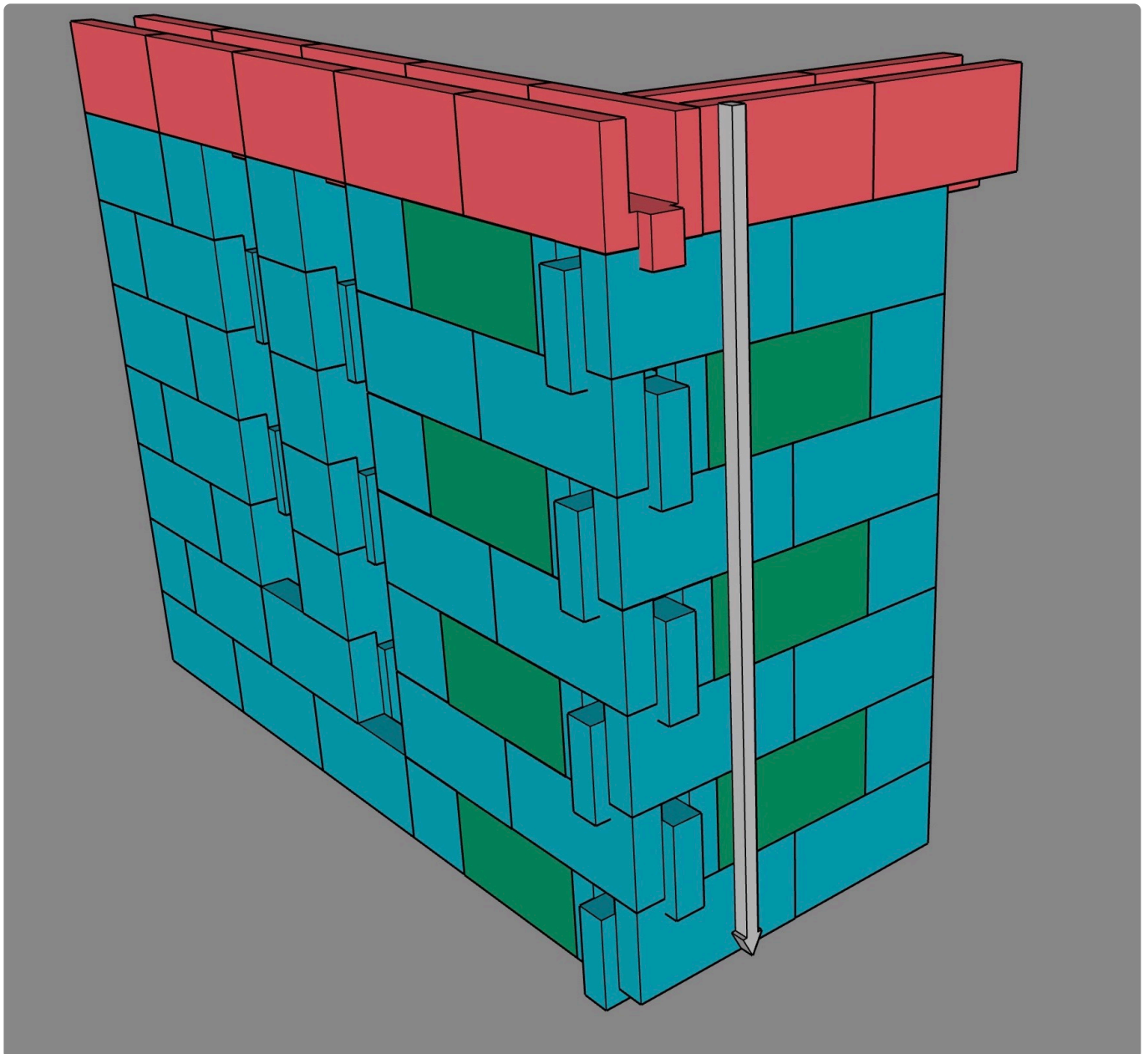

Some buildings might have been engineered with a steel bracing element. It will be encased by the HempBLOCKs.

Placed and secure the bracing elements first.









- split the block over long
- mark and cut out the material so the block fits around the frame with some room
- place the halves around the frame element with a thick glue on the connecting parts
- secure the halves with long screws and some glue- the screws can be taken out at a later stage -
- the block on top will be held together by the groove of the bottom block.

**Note:**

As the wall is build, the walls will slightly shift out of plumb because interlocking the blocks moves them. Check the 3 axes of the walls regularly. **Level** line, **plumb** and **vertical** so your blocks don't tilt in our out. Use packers where needed.

**Note:**

Best to have some struts in place on long walls and lintels to ensure blast winds dont push them over before they are reinforced.



[Building HempBLOCK walls 1](#)

[Building HempBLOCK walls 2](#)



Note:  
Here a demonstration how to handle your block-layer the next block;



<https://www.youtube.com/embed/QaVVpy5Lb6k?rel=0>

<https://www.youtube.com/embed/QaVVpy5Lb6k?rel=0>

<https://www.youtube.com/embed/QaVVpy5Lb6k?rel=0>

## STEP 6

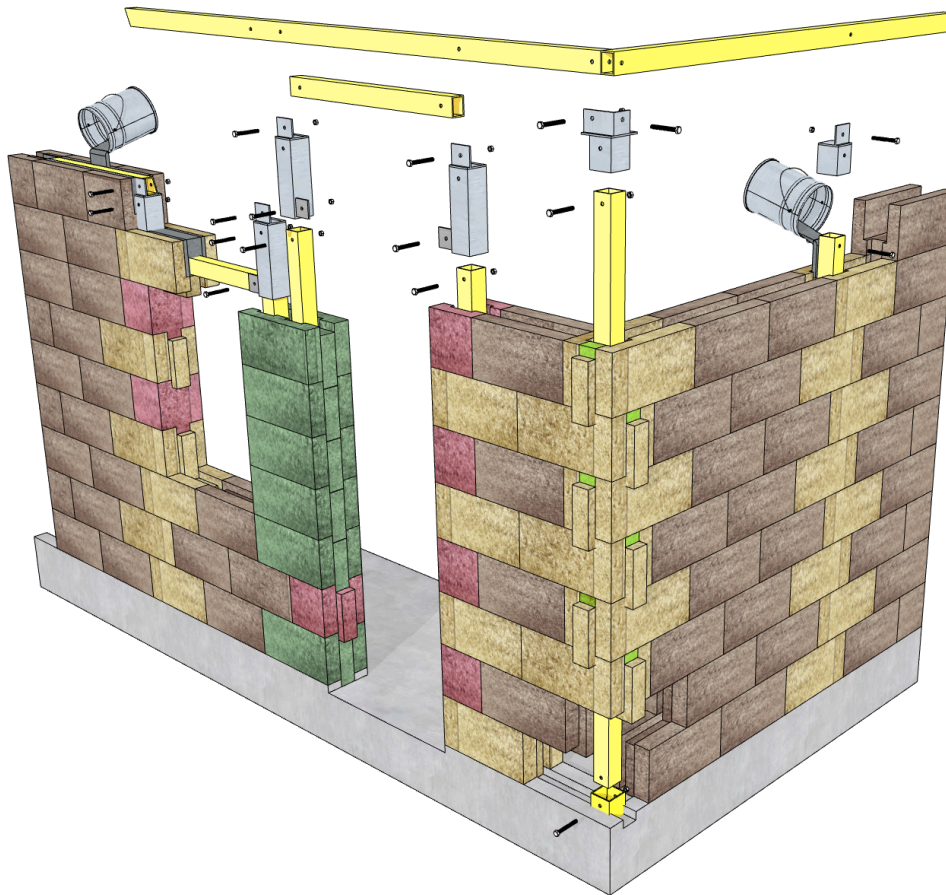

When you reach lintel or header height, you need to get the infrastructure for the load bearing system ready before continuing with laying blocks.

#### **STEP 7**

Lower down the prepared (pre drilled if you can and cut to height) FRP posts into the column blocks.

#### **STEP 8**

To have access to the brackets on the floor so they can be connected to the posts, cut a hole in the bottom column blocks.

This is not needed when starter blocks are used.

Connect the FRP posts to the floor brackets. Make sure the post is centre to the hole in the Column blocks.

#### **STEP 9**

Put the lintel supports in place. You might have to cut the thickness of the L brackets out of the top of the block receiving the U blocks.

Aluminium, or steel brackets, timber or steel supports can be used in combination with props that are properly secured to the brackets or supports.

#### **STEP 10**

Wax or oil the steel supports so the infill material does not bond to the steel surfaces.



You can also use packing tape and wax or oil it as it does not bind the L brackets to the perlite infill.



## STEP 11

Position the U blocks with at least 70mm support onto the corner column block.

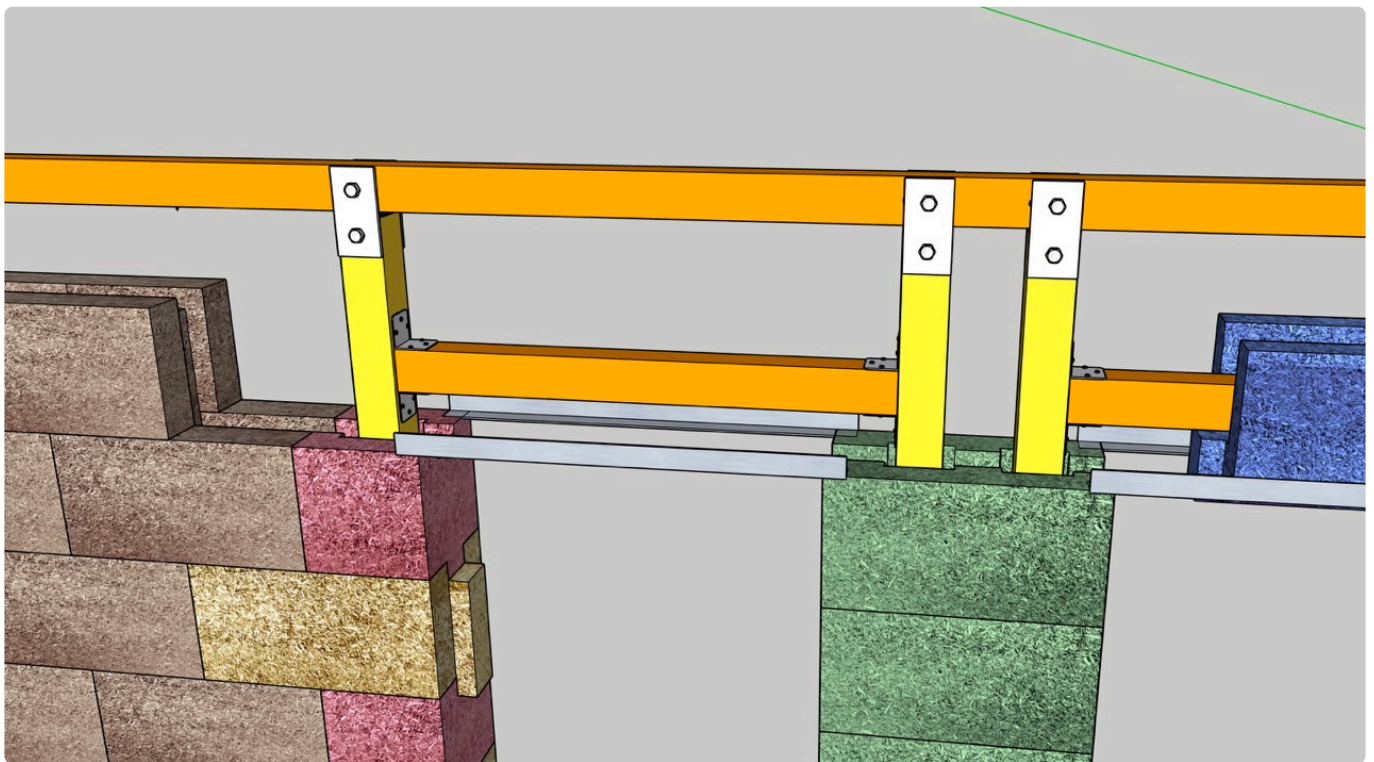
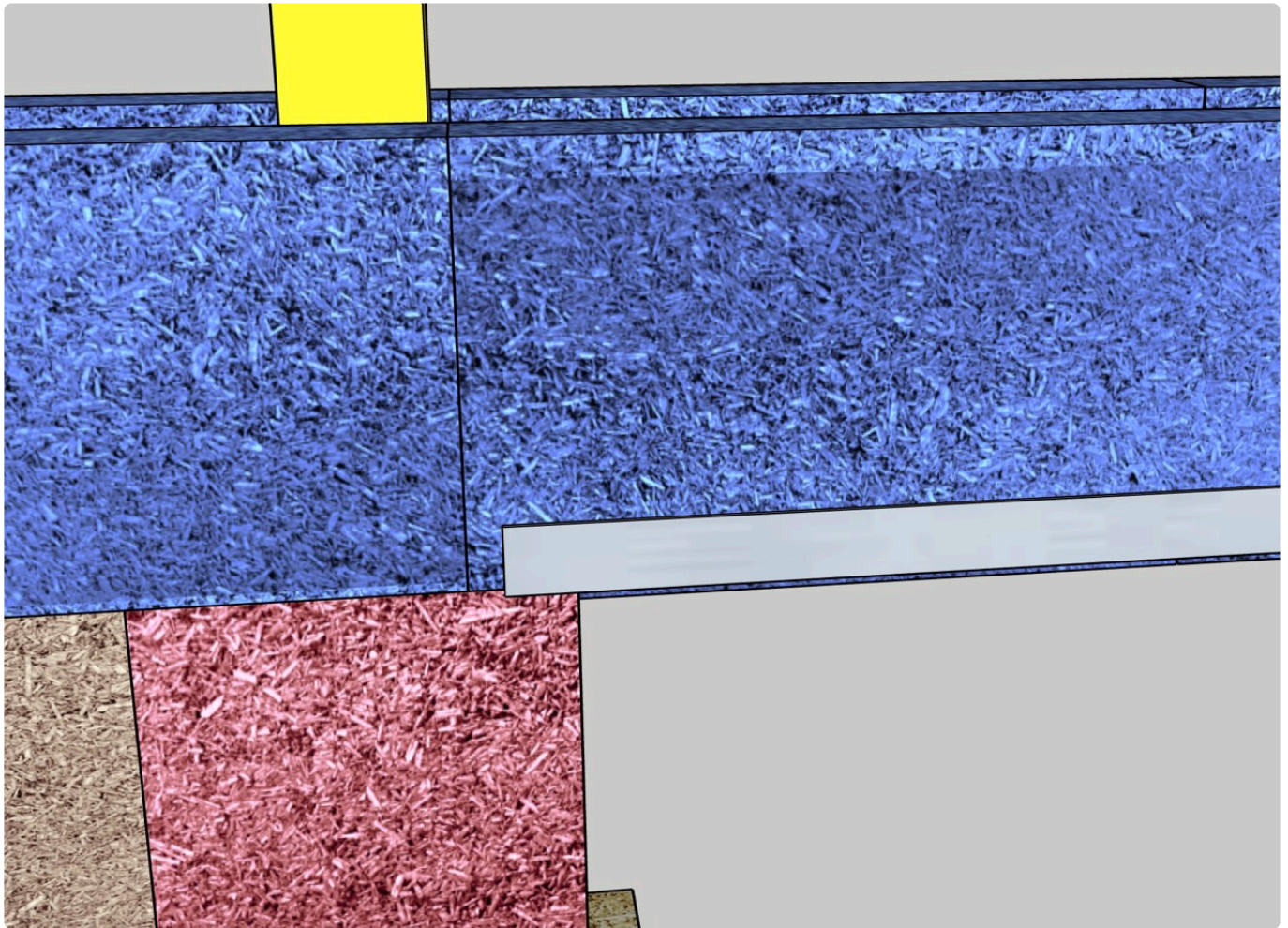

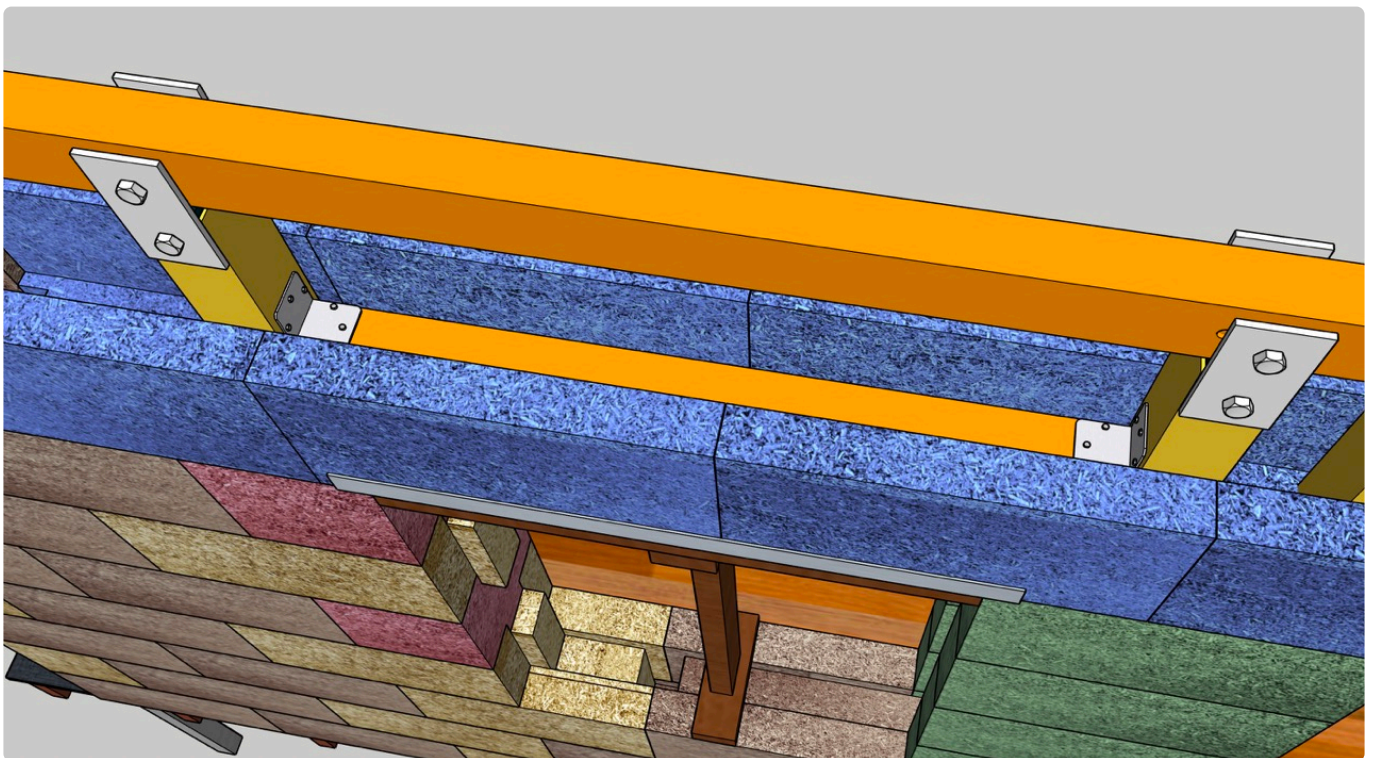
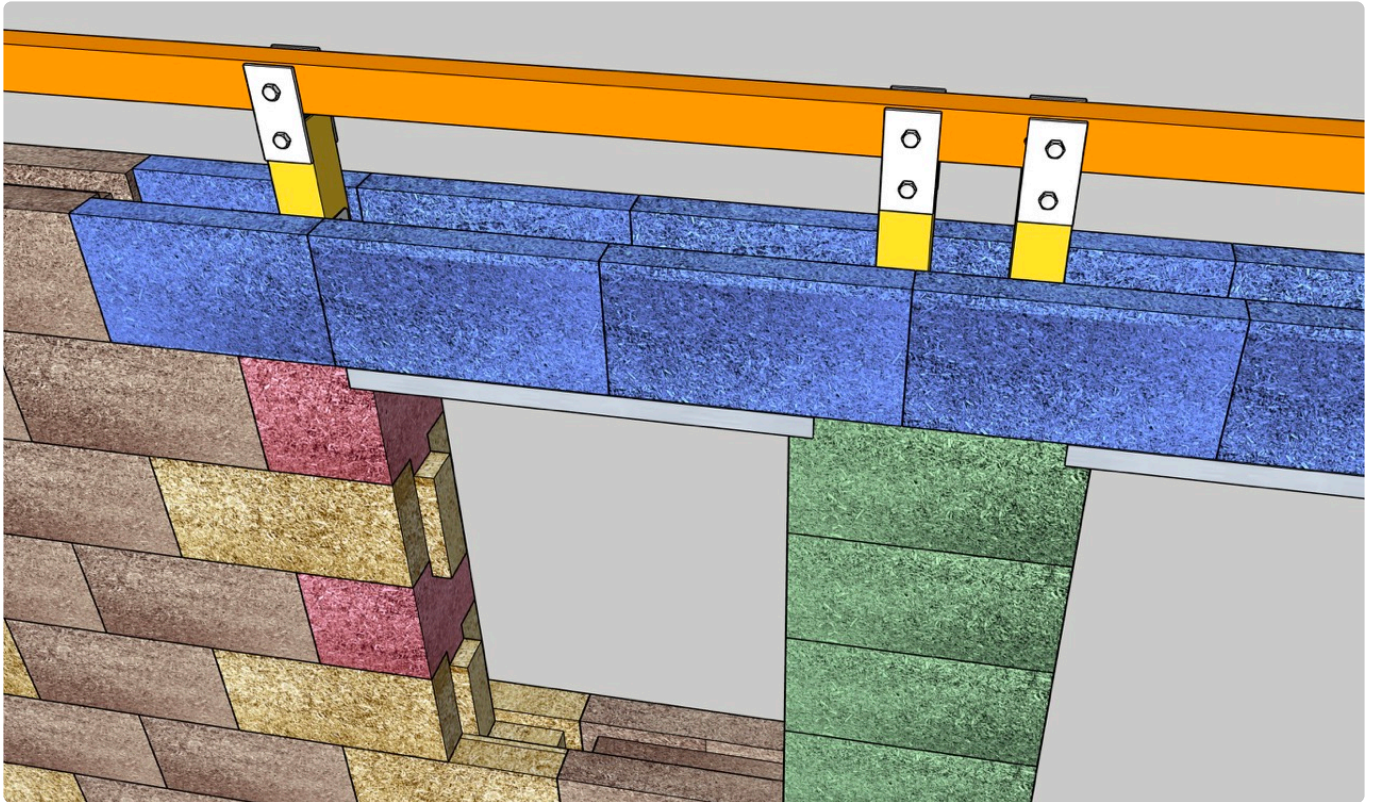

The first and last U block might need to [cut a 150 × 150 mm hole](#) if they overlap the column hole.

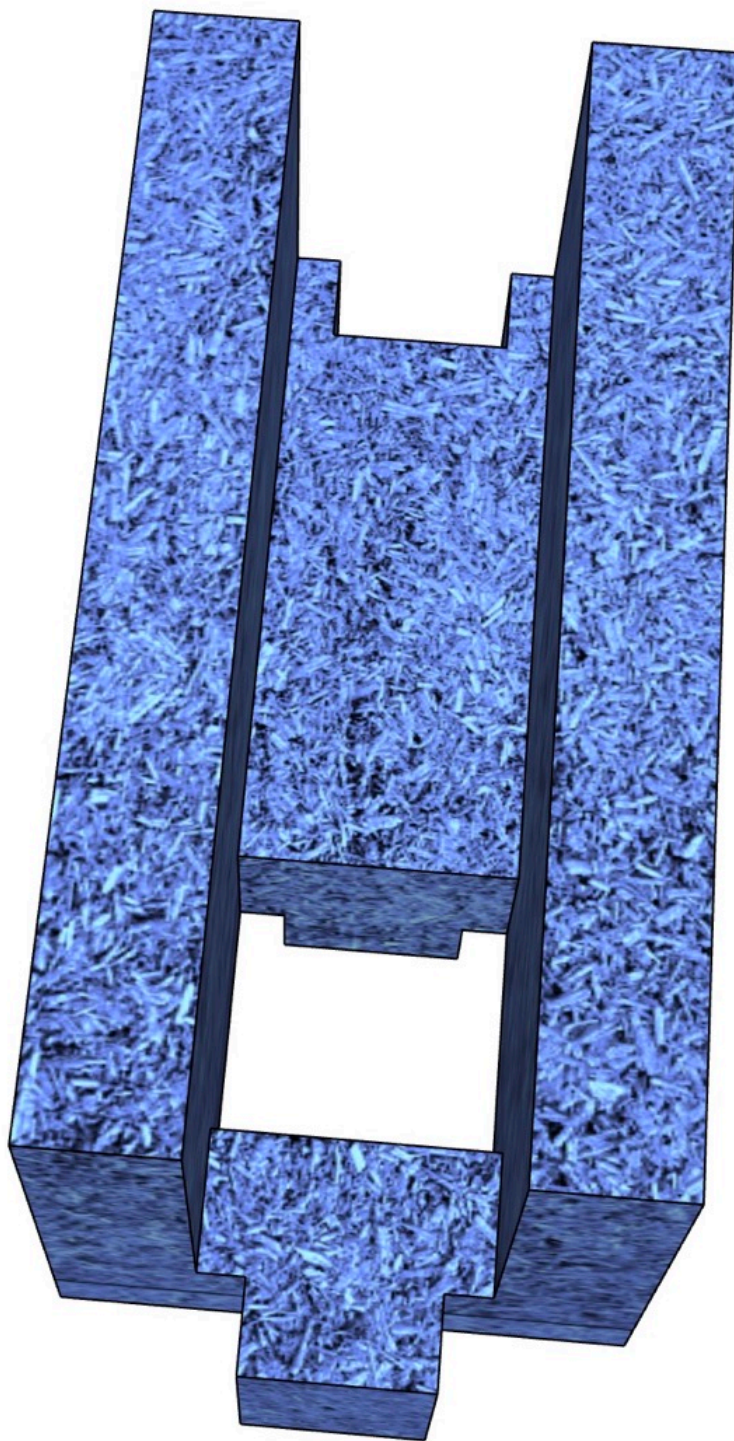



Above a picture of timber lintel block supports.



Above a picture of aluminium angles used as lintel/header block supports.

Secure the stays so they need to be solidly installed and can not fall to avoid injury and damage.

**\*STEP 12 \***

Prepare the headers or lintels before they are put into position.

The space between the load bearing system and U or lintel blocks will be filled with a perlite / cement mix.

For the infill to adhere to the timber or FRP lintels / headers we need to create a 'key'.

We do this with screws or dove tale timbers.

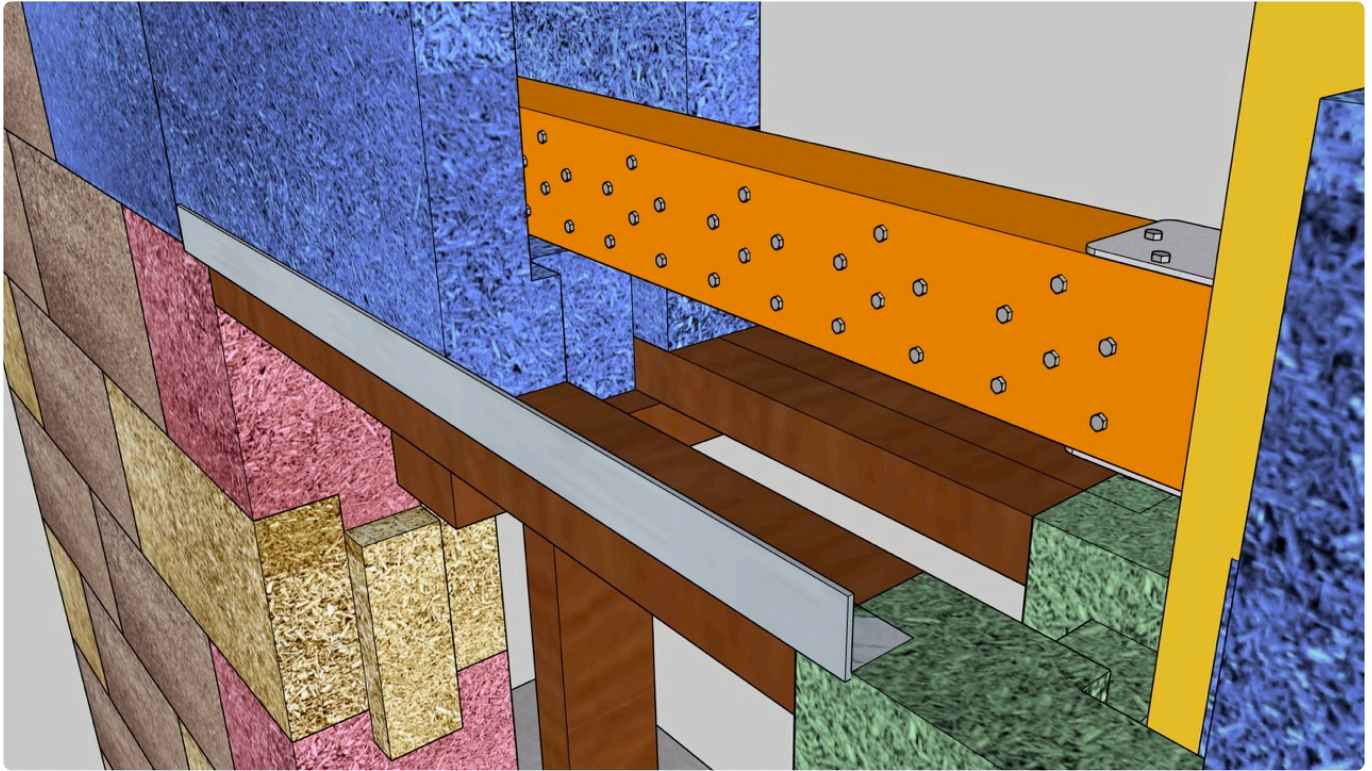

### STEP 13

Connect the posts to the lintels/ headers as per engineers specifications.

You might need to drill holes through the U blocks so you can insert the bolts and or needed fasteners to connect them.

Use engineer specified methods and fasteners.

Take pictures or have your engineer check the connections.



**STEP 14**

Remove all rubble and debris with an air blower.



**STEP 15**

Block the holes in the bottom column blocks and where holes have been made to connect the lintels / headers with the columns on both sides so the perlite mix does not flow out.

We use timber planks or ply and roofing screws to keep them temporarily in place.

**STEP 16**

Go around the walls and fill in other voids with either;

- hempcrete or a
- hempcrete/perlite mix
- lime mortar
- expandable foam

Pay attention to the gaps between the U blocks used to create the lintel / header. Concrete or the perlite mix will pour through it if not blocked off.







**STEP 17**

Brace and plumb the walls.



<https://www.youtube.com/embed/EZWAbn6phSs?rel=0>

<https://www.youtube.com/embed/EZWAbn6phSs?rel=0>

<https://www.youtube.com/embed/EZWAbn6phSs?rel=0>

You can fix and fill the walls in stages.

## STEP 18

Before casting the perlite infill around columns, lintels / headers and bond beams go through this check list;

1. check if all reinforcing is correctly attached. Make pictures for your engineer if needed.
2. have the engineer or certifier check your work if required
3. check if your walls are straight
4. check all walls are plumb
5. check if all columns and lintel blocks / headers are reinforced are connected properly aligned and centre to the blocks
6. check if all holes in the blocks are filled or blocked up. Boxing of the lower end of the walls needs to be strongest as the perlite mix will create some pressure on these parts
7. assure you can go around the walls to be filled with planks and safe platforms

✿ NOTE:  
[Perlite mix:](#)

**STEP 19**

Mix up the perlite mix.

Don't fill the voids when the blocks are still wet from excessive rain.

Pour the sills.

You can poke gently with a rod for the concrete to flow down past the cages.

Check for blow outs.

When reaching the bond beam and lintel / header, fill it and screed the top off.

**Method Sloping wall:****STEP 20**

After the perlite has set and hardened over a day or so, continue with laying the wall and work up to the final stage.

Here we place the lintel blocks or create the gables.

Over a lintel / header you have to cut the tongue of the next blocks. You can use a lime based mortar or thick glue like 'Liquid nails' to adhere the blocks to each other.

Standard there is non or only one more layer to go on top of the lintel / header.

This will then be your ring beam.

Cut the 150 × 150 mm hole or groove to lift the blocks over the post where needed.



<https://www.youtube.com/embed/XLIDflqJlec?rel=0>

<https://www.youtube.com/embed/XLIDflqJlec?rel=0>

<https://www.youtube.com/embed/XLIDflqJlec?rel=0>

## **STEP 21**

Prepare the ring beams.

For an FRP ring beam you may need to attach the Burmon brackets in advance and loop a steel strip around them to the beam.

## **STEP 22**

Place the U or lintel blocks.

In case of a sloping wall see **STEP 26**

## **STEP 23**

Connect the top plate to the FRP column as per engineering specifications.

## **STEP 24**

Repeat **STEP 17**

## **STEP 25**

Cast the perlite into the remaining column spaces and ring beam.

Screed the top of flat.

The wall is now ready for the roof!

## **STEP 26**

### **Method Sloping wall:**

There are a few ways to create a sloping wall.

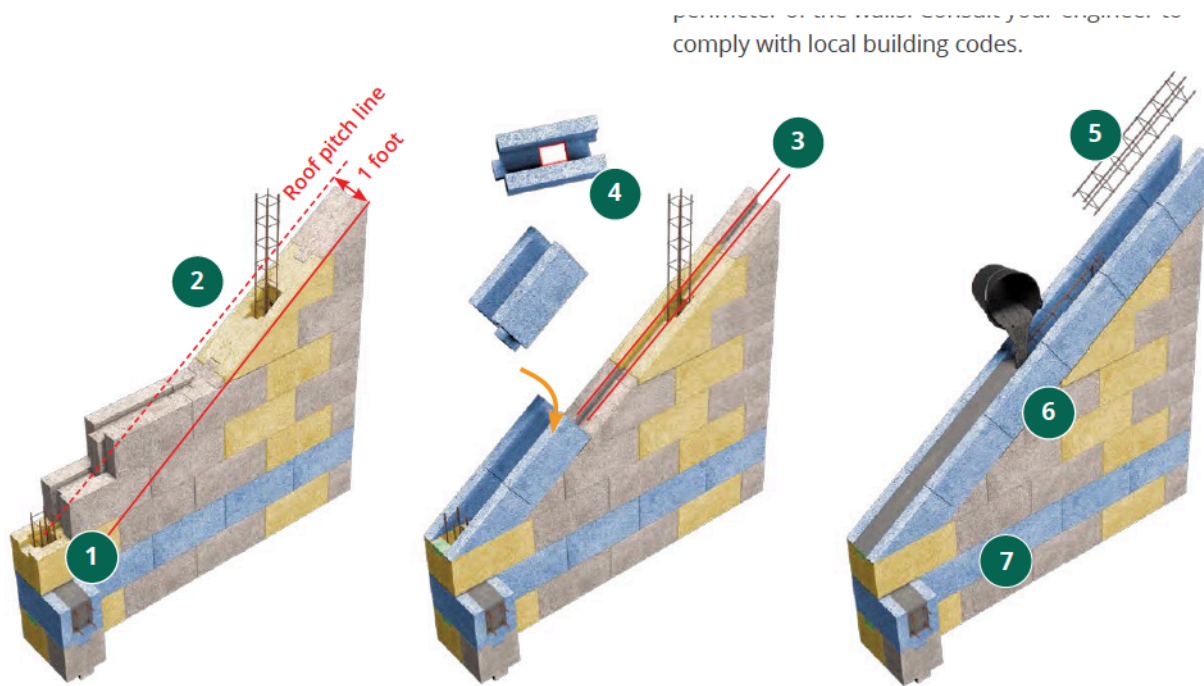

#### Method 1:

1. Build the wall with extended blocks one block short of the finished roofline
2. Mark the sloping roofline
3. Cut the wall on an angle but nice and level – as in hold the chainsaw level, perpendicular to the wall
4. Cut a groove to nestle the U Blocks in
5. Place the U blocks in the groove
6. continue as per **STEP 19**

#### Method 2:

1. Build the wall with extended blocks one block short of the finished roofline
2. Mark the sloping roofline
3. Cut the wall on an angle but nice and level – as in hold the chainsaw level, perpendicular to the wall
4. Cut the tongue of U blocks
5. Glue the U blocks to the sloped surface
6. Continue as per **STEP 19**

#### Method 3:

1. Build the wall with extended blocks on the finished roofline
2. Mark the sloping roofline
3. Cut the wall on an angle but nice and level – as in hold the chainsaw level, perpendicular to the wall
4. Cut a U channel groove to place the ring beam steel / timber / FRP members
5. Continue as per **STEP 19**



## 9. Wall heights, interior walls and second level floors

### Wall Heights:

The maximum height for a bond beam in a wall is on top of the 8<sup>th</sup> layer of blocks. So **9 blocks all up**. The top of this bond beam will be approximately 2895 mm of ffl. This is to create a bond beam along the entire perimeter of the walls. Before designing, consult your engineer.

Below illustrated wall heights with the concrete starter block installed.

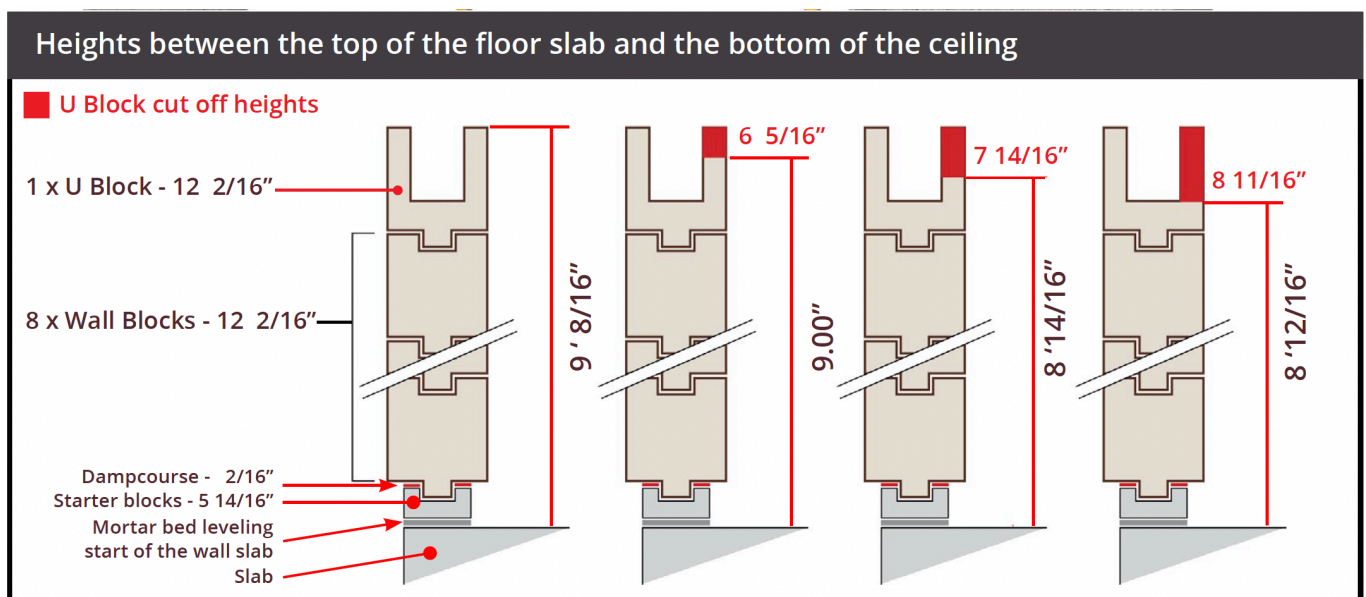

### Interior walls

Interior walls can be;

1. LB 300 HempBLOCK walls\*
2. HB series HempBLOCK walls\*
3. Standard timber framed or other walls\*

### LB 300 HempBLOCK walls;

If insulation (sound and thermal) is required on structural walls, you can use the LB 300 blocks. The blocks of the walls can be "zipped in"

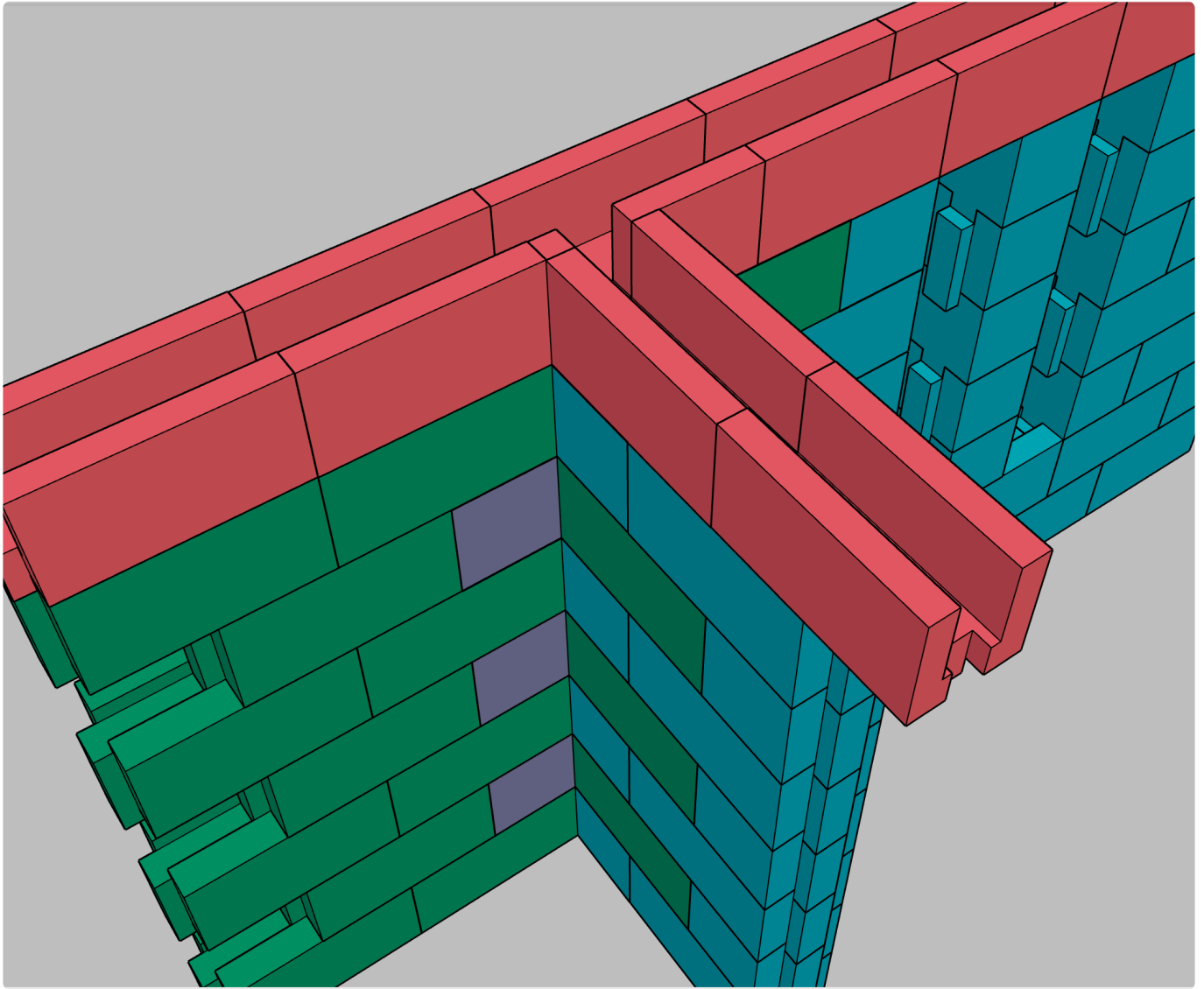

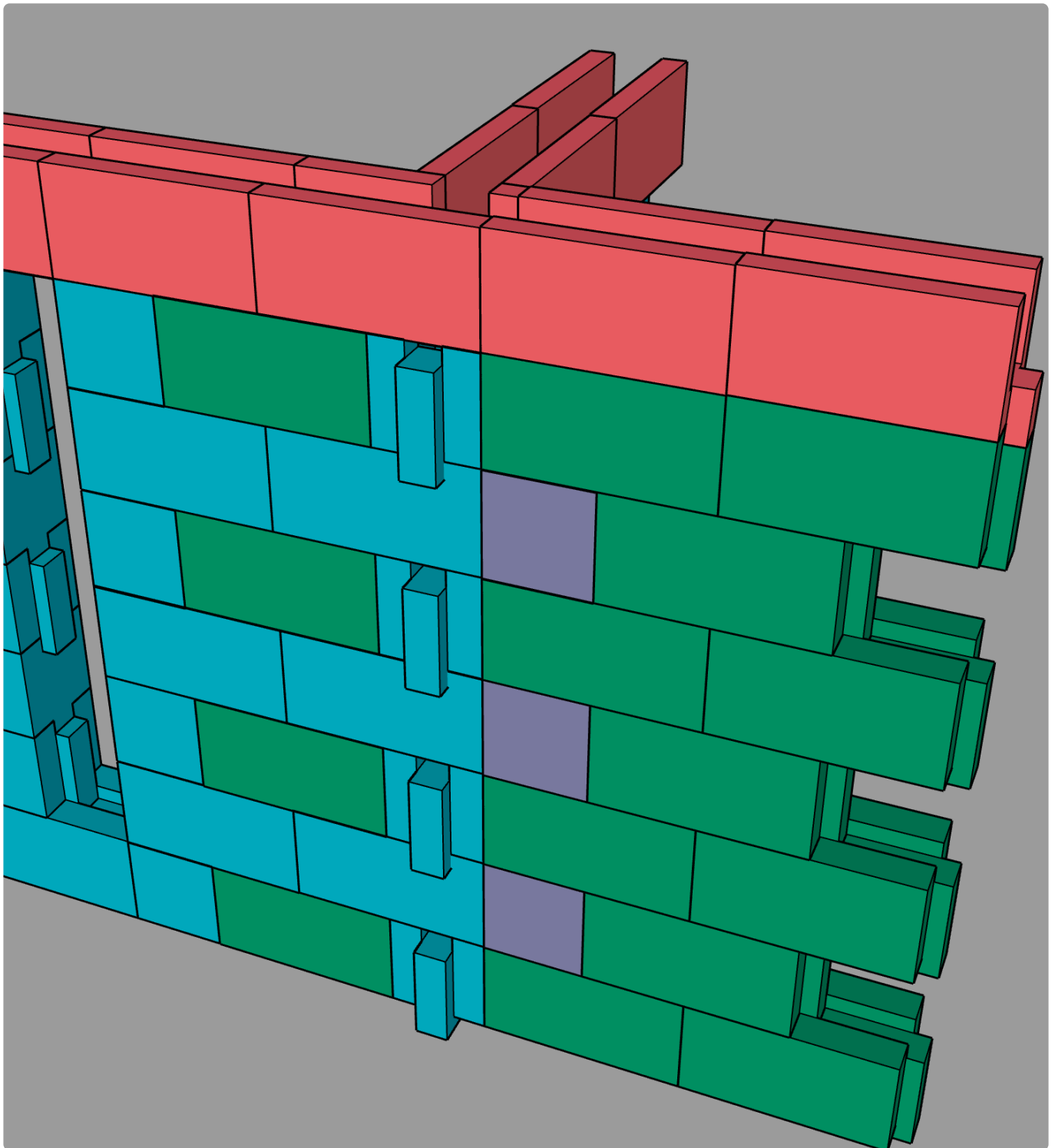

or constructed as a **seperate wall.**

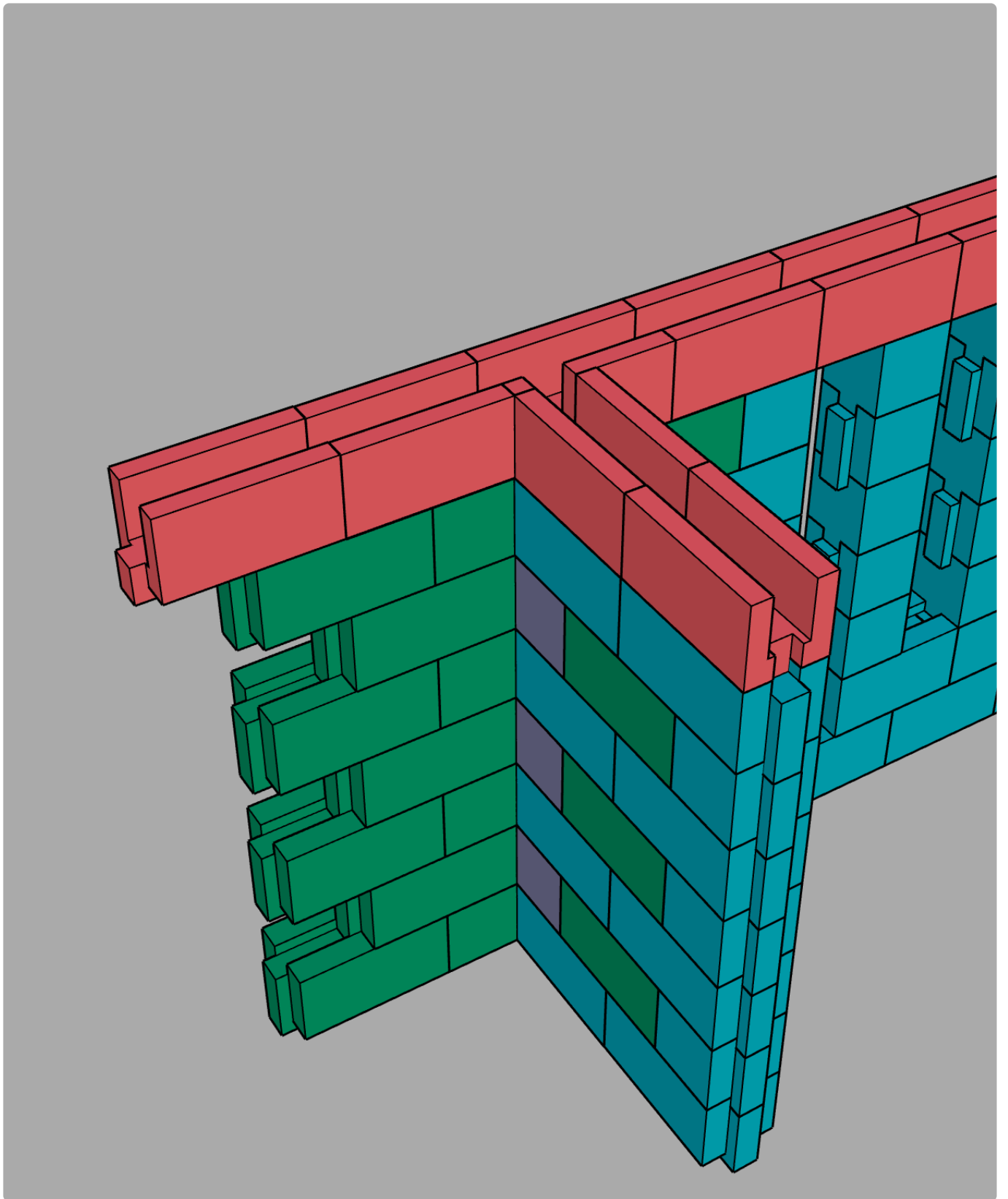

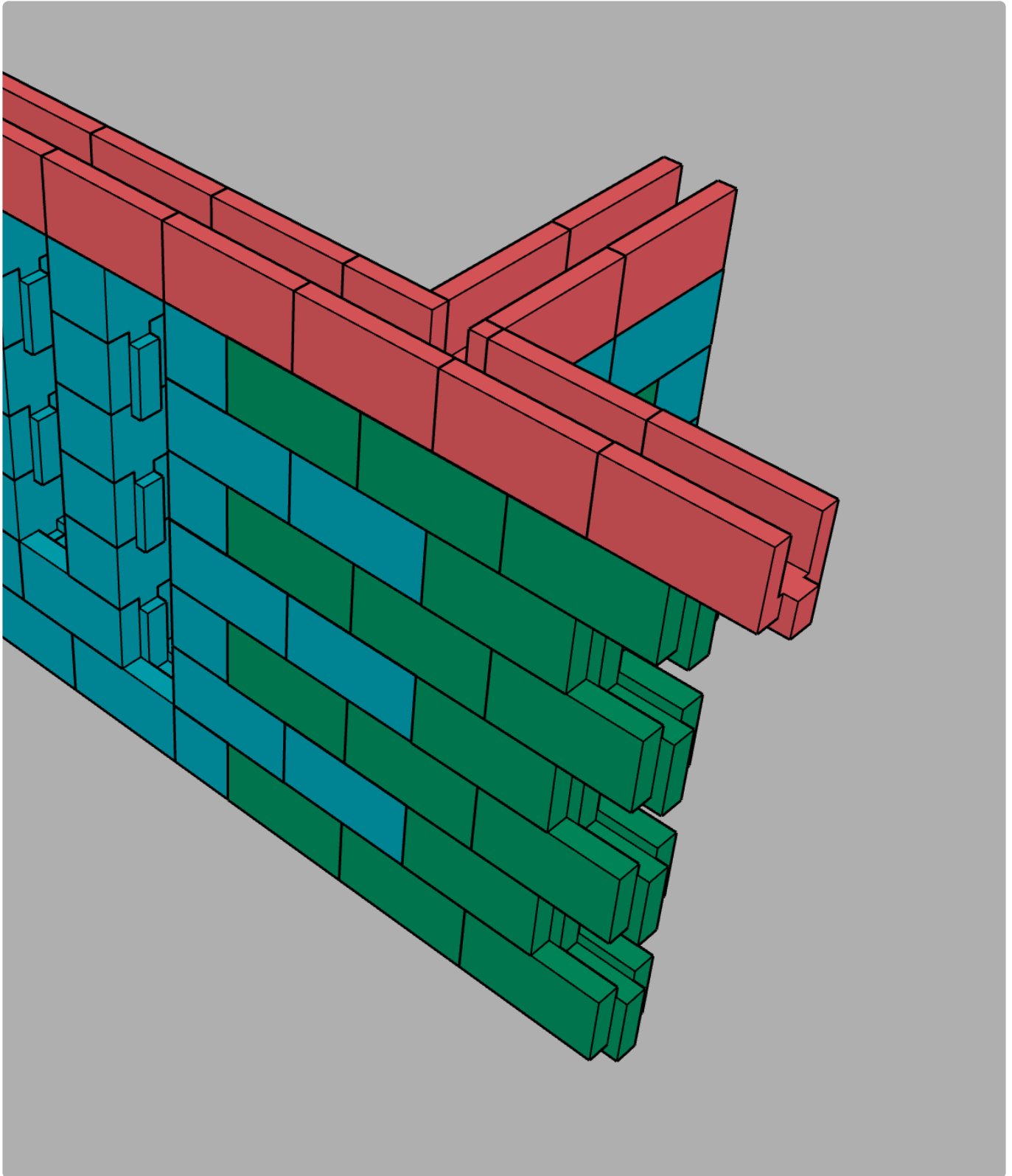

The bond beam will connect the walls at the top. So will the lime render with its embedded mesh layer. To connect the walls further, use block ties that are embedded in the main wall and lay between layers of the perpendicular wall with some adhesive, or mortar.

Make sure you create some space by scratching out some hempcrete for the additional thickness of the block tie and glue.

# Second level floors

Below second floor options based on the steel reinforced concrete system.

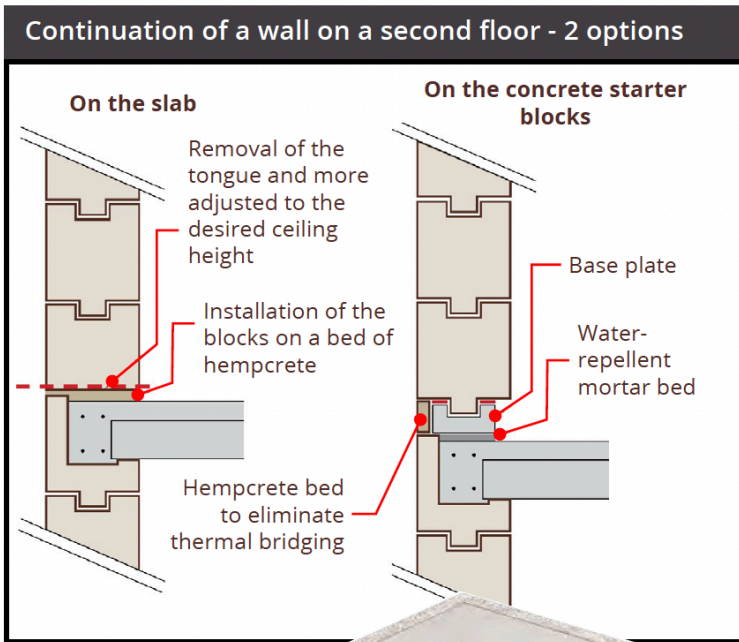

- 1 Cut the U blocks to ensure continuity of the bond beam.
- 2 Installation of the steel reinforcing to engineer's specifications
- 3 Strutting of the edges.
- 4 Installation the beams / floor.
- 5 Installation of the floor segments and reinforcing.
- 6 Pour the slab and bond beam in one go.

Installation of the flooring according to engineer's specifications

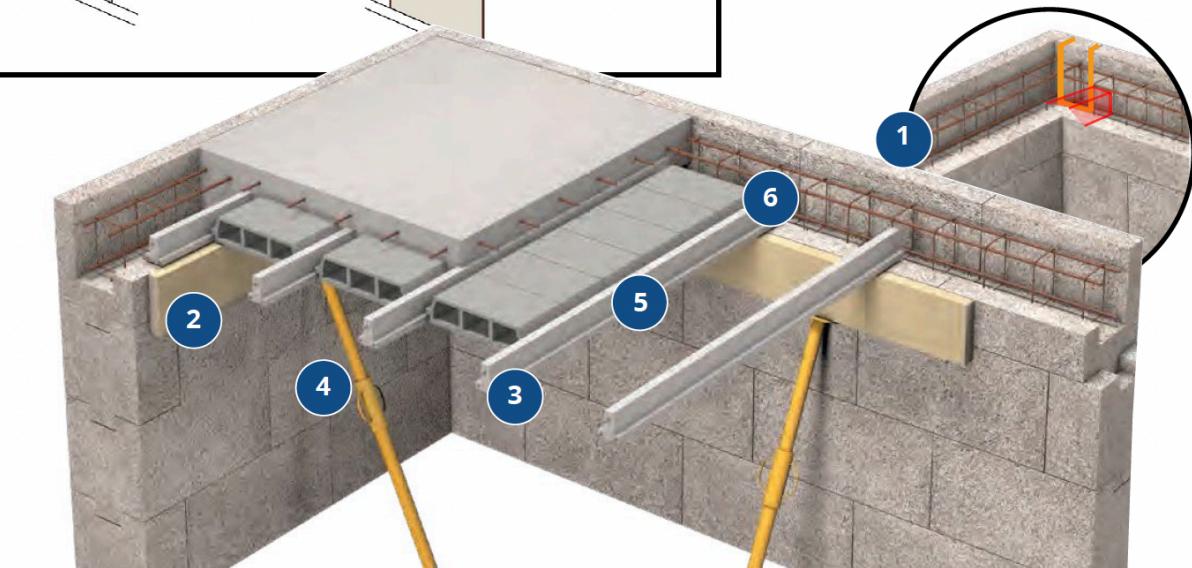

This will be similar with a (bottom floor) timber top plate where the floor joists are hanging in saddles or are resting on top of that ring beam.

Your engineering specifications will provide you detailed construction details.

# 10. Embedding services in the wall

---

Services are to be installed to local building codes.

As per construction code AS 3700 4.3, 3600 14.2 and AS 3000-3.9.4.2 to embed services in a concrete wall.

The easiest way to chase a groove in the wall is with a chainsaw. See the video [here](#)

## Plumbing

All copper, metal and zinc pipes must be sleeved when embedded in the walls.

Water pipes that are embedded in the wall should be clipped and lagged as per AS/NZS 3500 2.8.3 and installed to AS 3.4.2.6.

Larger service openings such as sewer pipes that penetrate the walls can be repaired with expanding foam.

These holes can be made with a chain saw or big hole saws.

Embed the pipes at least 50mm the wall surface or as per local codes.

The heat from hot water pipes will not affect the hempcrete. Hempcrete is heat and fire resistant, but flues should be isolated to AS standards 3.7.3.4 & 3.7.3.5.

## Electrical

All electrical ducts must be at least embedded 50mm into the wall surface.









If grooves in the finished hempcrete wall are made for the services, the grooves can be filled with expandable foam, hempcrete or the render.

See chapter on Render.

Electrical conduit, brackets and sockets should be installed as per AS 3.4.2.6.

As per pictures above, the plates will be screwed to the wall with additional reinforcing with some glue. They will be covered over by the render and mesh to create a solid backing plate for the electrical element. Spend enough time to assure the power plugs are fastened solidly. They will be exposed to pulling plugs out.

# 11. Render, wall finishes, windows and doors

---

Exterior HempBLOCK walls are not be be left exposed for a prolonged time due to the following reasons;

1. The first coat of lime render acts as a bandaid to keep the wall structure together as it will have a layer of 10mm fibre glass mesh embedded in it. External and internal walls need to be lime render coated with at least one layer of mesh embedded in the first coat.
2. The block walls are mean to be covered as external weather conditions will influence the wall surface over time. The wall surface is open. Air residue (pollen, dust, dirt, pollution) will settle in the crevices.
3. Your wall will have a better insulation performance with lime render finishes.

## Lime render

Here some *guidelines* on rendering. Seek professional guidance on your lime render application and finish options.

Rendering the HempBLOCK walls with Lime render is the standard finish.

\* First coat; 10 mm with a fibre mesh embedded.

\* Second coat: 3-5 mm finished as per requirements.

Internal walls can be coated with lime and clay renders or clad/sided. See below.

We recommend to contract a plasterer or lime renderer. They are geared up and experienced in the application plus they will be able to show you a variety of finishes.

Alternatively you can follow a render training.

Choose only HBUSA approved lime render finishes.

Install sills and flashing of the openings / windows / doors as per code/ engineering design. See below.

Prepare your floor, ceiling and windows with tape and plastic / paper protection.

Fill major holes with a hempcrete mix (hempcrete shavings from cutting blocks mixed with lime render or preferably a binder or lime mortar), expandable foam or HempBLOCK rubble. Ensure there are no loose particles on the wall ie. the whole surface is solid and dust free.

Blow the walls off if very dusty.

Seal and fill around extruding cervices.

The whole inner and outer surface should be meshed and angled and coated as per render standards. A key, scratch or stipple coat is not needed. The blocks provide excellent adhesion to the render.

Mesh overlaps should be at least 4 inches / 100 mm

### First coat



**Embed the mesh**





**Rub it in**

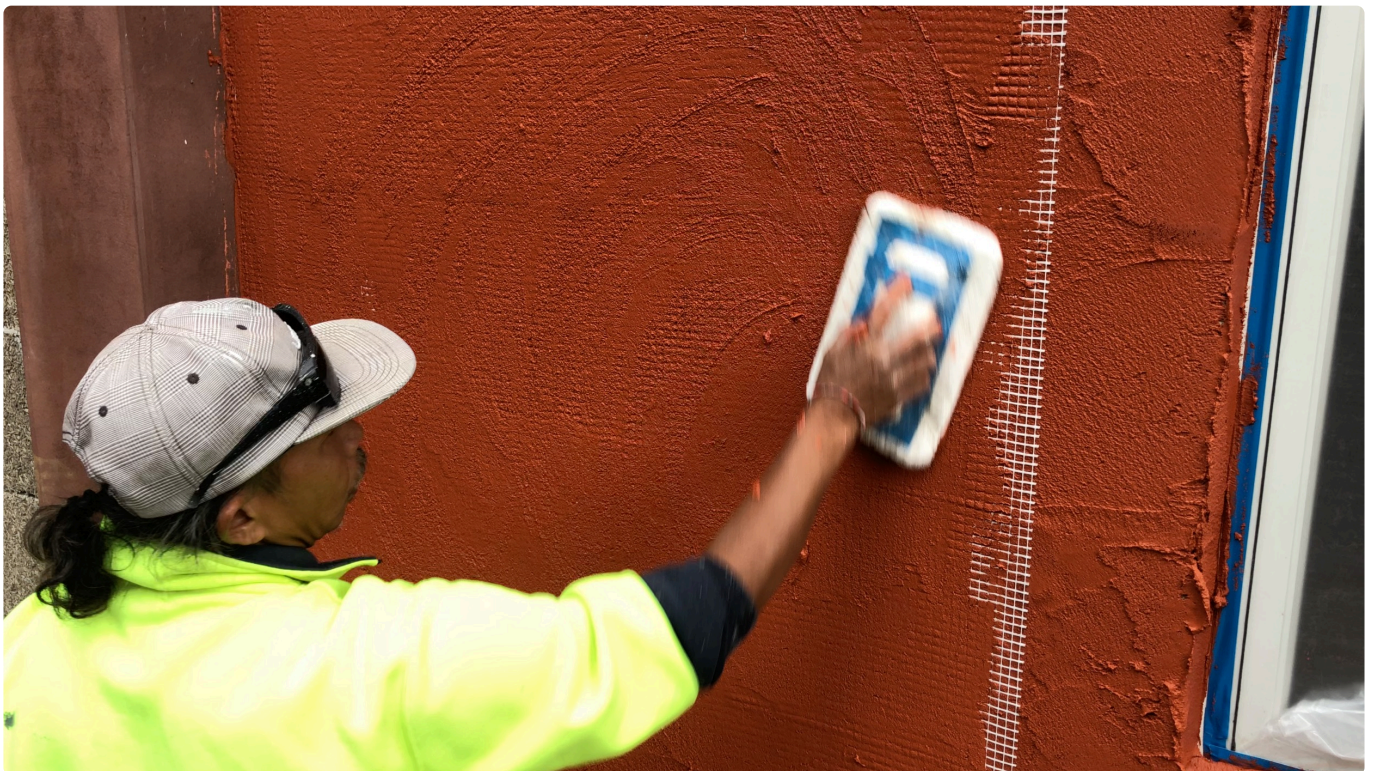



\*Ensure you have meshed all surfaces with emphasis on headers and their surrounds reinforced with the mesh. \*

Render to manufacturers specifications. Contact our technical team for further advice if required. Lime and clay render finishes assure breathability of the hempcrete walls. HBU provides quality render in a variety of colours.

If you intended to render yourself please ensure to follow our recommendations and the lime render instructions.

You can curve the walls (see tools, a demonstration [here](#)). This will make the job faster and easier for the renderer because they dont need to edge your corners with a bead.



Image of external renders edge

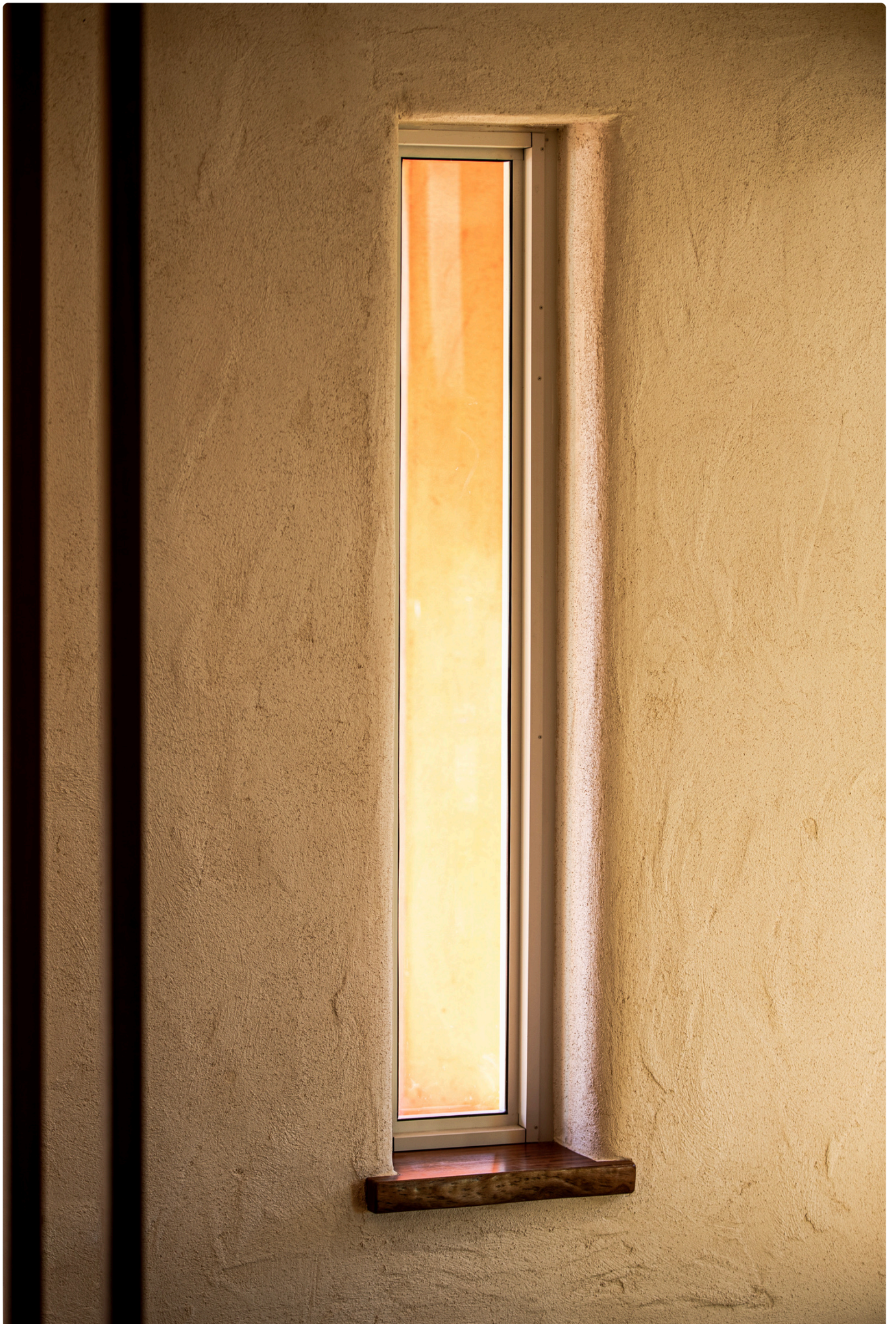



Image of rounded edges.

## Breathable water repellents;

There are water repellents on the market that you can additionally apply to the finished lime render surfaces.

They are often a beeswax or similar solution that is sprayable with a mister or by brush application. Water drops will bead when rain hits the wall, or the effect of another product is that the water will spread and flow off.

Essential is that the finishes are breathable and preferably non toxic. Check if they are compatible with the used lime renders.

## Windows & Door installation, Flashing

There is a merit of varieties of window and door frames.

Besides that you can have the window flush with the exterior wall, or interior wall or in the middle.

You can rebait the opening or – easiest – lay your blocks so it fits the window frame.

Essential is to have the windows and doors attached as per code to the frame with the correct required amount of fasteners as per wind loading and/or code.

Fasten into the posts, sill and header with appropriate long screws.

The sills should be installed as per wall installation guide.

Flash and seal your openings from the outside as per code.

You can use stainless, earthen, concrete, brick or wooden sills or angle the hempcrete sill surface to at least 15° and render over it.

### [Window detail suggestions PDF](#)

In the case of the images below, there is a minimal gap between the window frame and the window opening.

We did fill it with expandable foam and will seal it with an aluminium strip;



We put a line of sealant on the back to the aluminium strip.



And clip it behind the lip of the window frame.



And screw it to the wall with a long screw.



We seal the edge between the strip and the wall.



The render will go over the grey bead of sealant and surface where the screw is embedded, to double seal that surface.

Please find below some window details including shutter and roller shutter system installation.

**Installation of hinged shutters**

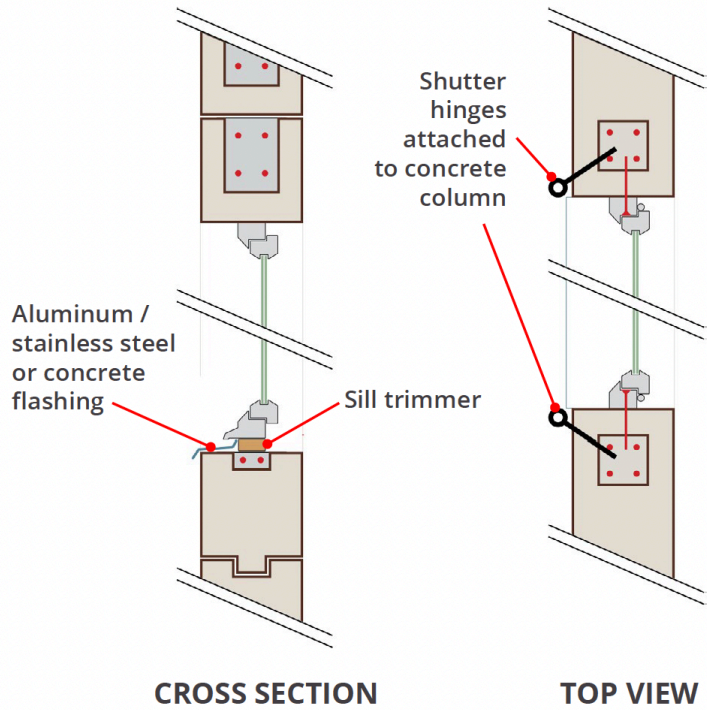

**Installation of roller shutter system**

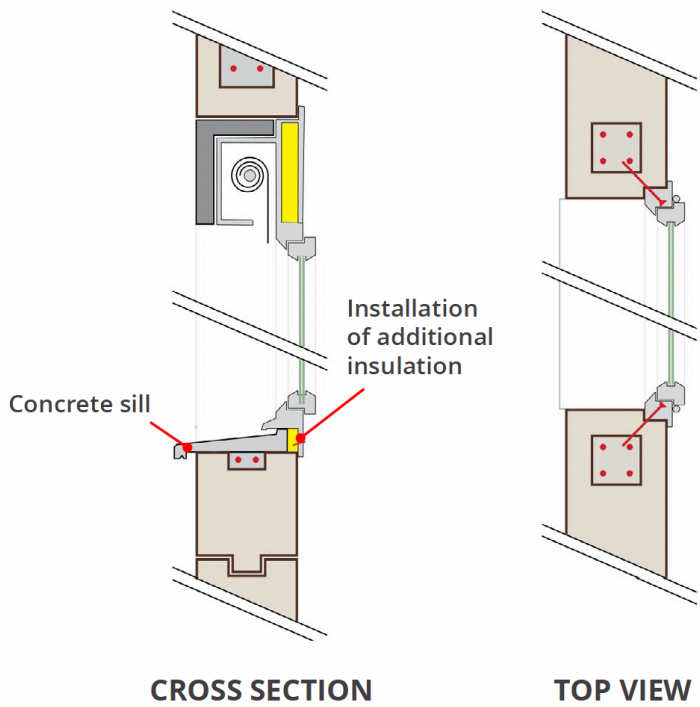

**Siding / cladding**

Drywall or Plasterboard can be applied straight onto the finished HempBLOCK walls.

Use glue and long screws to help the sheets to set. You can remove them after and finish as per usual plastering procedure.

**PLEASE NOTE:**

Lime plaster is breathable to a certain extent. To keep its breathability, don't finish the surface with plastic acrylic paints but rather use lime washes or breathable finishes.

Here some samples of chalk paints on a lime rendered fibre cement backing;







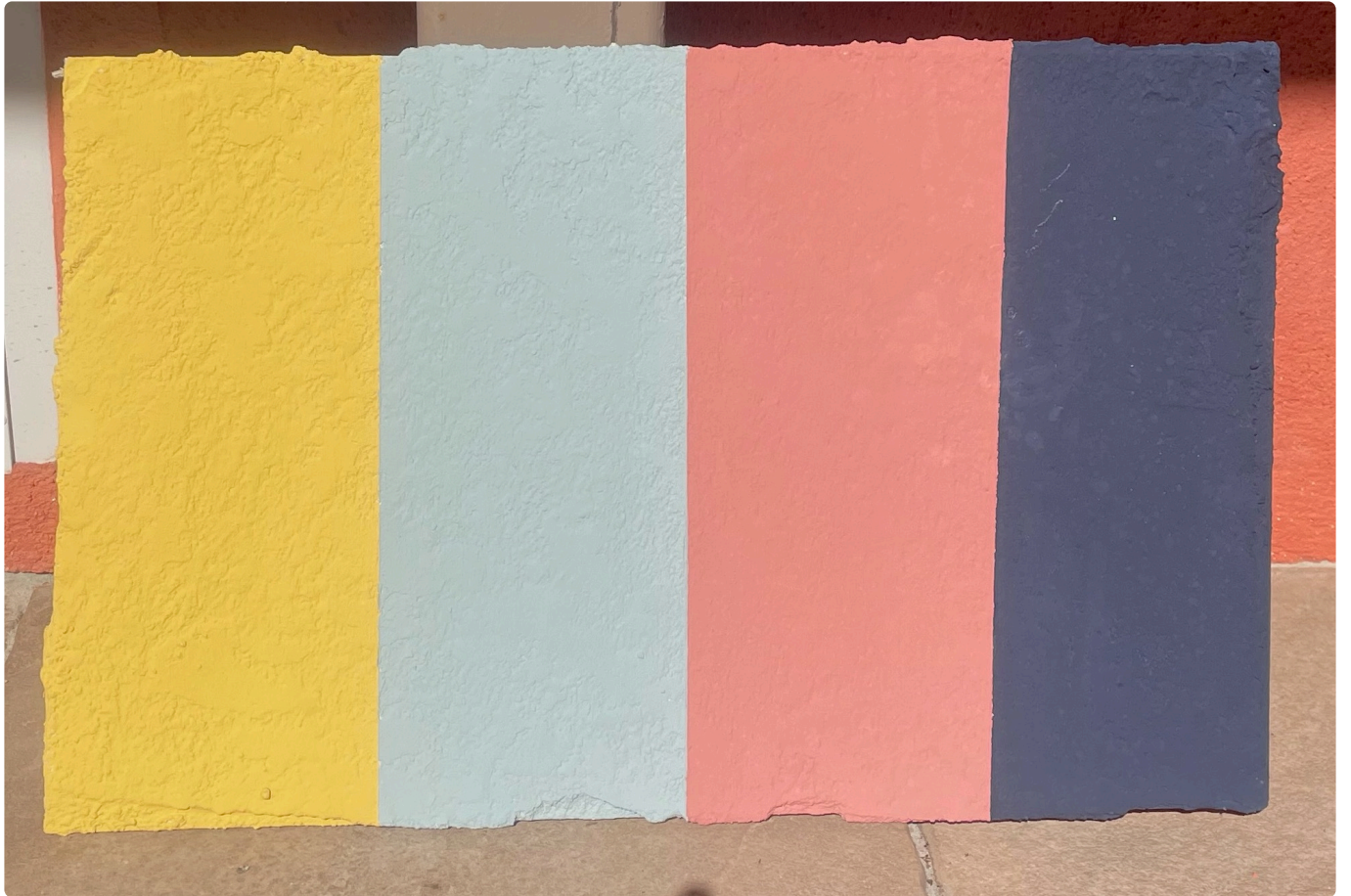

## 12. Battening out walls

---

Walls can be [battened out](#) to finish them with sheeting or plank cladding.

To save space, the use of treated pine planks or decking is recommended.

**Needed: plugs, screws and a thick fast setting (preferred) glue**



**Mark and drill the holes for the plugs, squeeze some glue and enter plugs in the holes**



**Add some adhesive to the back of the batten after the glue of the plugs has set**



\*Affix the batten with the screws to the wall \*



**Now the wall is ready for sheeting.**

! Please note: Sheet with screw fasteners so the percussion of nailing is not possibly compromising the adhesion of the battens.